



- Euclide _____
- Filo _____
- Cartesian _____
- Eg _____
- Anello _____
- Aki _____
- Olo _____
- Linea _____
- Lamoi _____
- Lamoi 2.0 _____
- Tesa _____
- Tesa 2.0 _____
- Lafra _____
- Lafra 2.0 _____
- Beba _____

URBAN[®]
IDEE CHE DIVENTANO LUCE

U14

URBAN[®]
IDEE CHE DIVENTANO LUCE

Table of contents

AKI	132
TECHNICAL DATA	147
PRICE LIST	330
ANELLO	96
TECHNICAL DATA	109-121-131
PRICE LIST	324
BEBA	294
TECHNICAL DATA	313
PRICE LIST	358
CARTESIAN	66
TECHNICAL DATA	76-78-84
PRICE LIST	321
EG	86
TECHNICAL DATA	95
PRICE LIST	323
EUCLIDE	10
TECHNICAL DATA	23-33-39-43
PRICE LIST	316
FILO	44
TECHNICAL DATA	57-65
PRICE LIST	319
LAFRA	270
TECHNICAL DATA	283-293
PRICE LIST	354
LAFRA 2.0	278
TECHNICAL DATA	283-293
PRICE LIST	356
LAMOI	200
TECHNICAL DATA	215
PRICE LIST	346
LAMOI 2.0	208
TECHNICAL DATA	215
PRICE LIST	350
LINEA	164
TECHNICAL DATA	174-184-188-196-198
PRICE LIST	334
OLO	148
TECHNICAL DATA	163
PRICE LIST	332
TESA	232
TECHNICAL DATA	241-253
PRICE LIST	352
TESA 2.0	254
TECHNICAL DATA	263-269
PRICE LIST	353

TABLE OF CONTENTS BY TYPE

INDICE PER TIPOLOGIA / INHALTSVERZEICHNIS NACH TYPOLOGIE / ÍNDICE POR TIPO / УКАЗАТЕЛЬ ПО ТИПУ

SUSPENSION LAMPS

Lampade a sospensione
Pendelleuchten
Lámparas colgantes
Подвесные светильники

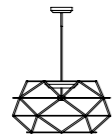

EUCLIDE
1821-1822



p 10 / 23



FILO
1839-1840



p 44 / 57

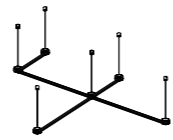

CARTESIAN
1832



p 80 / 85



ANELLO
1790-1799
1800-1801



p 110 / 121

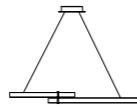

ANELLO
1790-1799
1800-1801



p 122 / 131



LINEA
1795



p 164 / 175

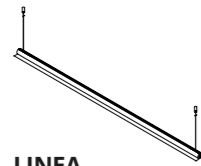

LINEA
1795



p 190 / 199

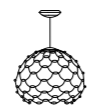

LAMOI
1812-1816-1817



p 200 / 207

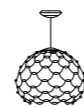

LAMOI 2.0
1831



p 208 / 215



TESA
1836-1937



p 232 / 241



TESA 2.0
1838



p 254 / 263



BEBA
1730



p 294 / 313

TABLE OF CONTENTS BY TYPE

INDICE PER TIPOLOGIA / INHALTSVERZEICHNIS NACH TYPOLOGIE / ÍNDICE POR TIPO / УКАЗАТЕЛЬ ПО ТИПУ

CEILING LAMPS

Lampade a soffitto
Deckenleuchten
Lámparas de techo
Потолочные светильники

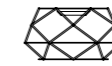

EUCLIDE
1821-1822



p 24 / 33



FILO
1839-1840



p 58 / 65

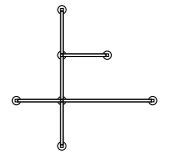

CARTESIAN
1832



p 66 / 79



EG
1828-1829-1830



p 86 / 95



ANELLO
1790-1799
1800-1801



p 96 / 109



LINEA
1795



p 180 / 185



TESA
1836-1937



p 242 / 253

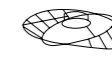

TESA 2.0
1838



p 264 / 269



LAMOI
1812-1816-1817



p 216 / 219

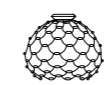

LAMOI 2.0
1831



p 220 / 227



LAFRA
1834



p 270 / 279



LAFRA 2.0
1834













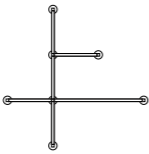











p 280 / 283

TABLE OF CONTENTS BY TYPE

INDICE PER TIPOLOGIA / INHALTSVERZEICHNIS NACH TYPOLOGIE / ÍNDICE POR TIPO / УКАЗАТЕЛЬ ПО ТИПУ

WALL LAMPS
 Lampade da parete
 Wandlleuchten
 Lámparas de pared
 Настенные светильники

 EUCLIDE 1821-1822  p 34 / 39	 CARTESIAN 1832  p 66 / 79	 EG 1828-1829-1830  p 86 / 95
 AKI 1796-1797-1798 1823-1835  p 132 / 147	 OLO 1776-1791-1792 1793-1824  p 148 / 163	 LINEA 1795  p 176 / 179
 LAFRA 1833  p 284 / 287	 LAFRA 2.0 1834  p 288 / 293	
 EUCLIDE 1821-1822  p 40 / 43	 LINEA 1795  p 186 / 189	 LAMOI 1812-1816-1817  p 228 / 231

FLOOR LAMPS
 Lampade da terra
 Stehleuchten
 Lámparas de pie
 Напольные светильники

TABLE OF CONTENTS BY CODE

INDICE PER CODICE / INHALTSVERZEICHNIS NACH ARTIKELNUMMER / ÍNDICE POR REFERENCIA / УКАЗАТЕЛЬ ПО КОДУ

CODE	ART.	PAG.
1730	BEBA	294
1776	OLO	152
1790	ANELLO	97-110-122
1791	OLO	154
1792	OLO	156
1793	OLO	158
1795	LINEA	165
1796	AKI	136
1798	AKI	142
1799	ANELLO	100-114-128
1800	ANELLO	104-116-127
1801	ANELLO	106-118-126
1810	LINEA	186
1811	LINEA	188
1812	LAMOI	202-216
1816	LAMOI	201-206
1817	LAMOI	206-217-230
1821	EUCLIDE	11-24-34-40
1822	EUCLIDE	16-28-36-41
1823	AKI	144
1824	OLO	160
1828	EG	88
1829	EG	90
1830	EG	92
1831	LAMOI 2.0	208-220
1832	CARTESIAN	80
1833	LAFRA	270-284
1834	LAFRA 2.0	278-288
1835	AKI	140
1836	TESA	236-248
1837	TESA	232-242
1838	TESA 2.0	254-264
1839	FILO	52-62
1840	FILO	45-58
1841	AKI	147

DESIGNERS

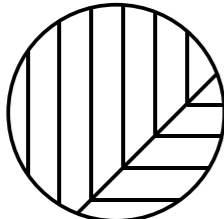

Acero.

Acero Design Studio



Andrea Barra



_blank design studio



Extravergine



Gerardo Mari



Marco Spatti

EUCLIDE

Gerardo Mari

EUCLIDE

Impalpable form of living light.
This family of lamps consists of geometric structures formed by the light source.
Impalpable, almost ethereal, shapes materialise with light.
The light sources make up the structure and define the volume.
The effect is pure light magic.
The structure contains the LED power cables.
Euclide is eco-friendly, with minimum power and materials required for its construction.

EUCLIDE

Impalpabile forma di luce viva. Questa famiglia di lampade è composta da strutture geometriche costituite dalla sorgente luminosa stessa. Impalpabili quasi eteree, le forme si materializzano con la luce, sono le sorgenti luminose a comporre la struttura e definire il volume. L'effetto è magia di pura luce. La corrente per alimentare i Led passa attraverso la struttura. Euclide è eco friendly, utilizza il minimo di energia e di materia per la realizzazione.

EUCLIDE

Ungreifbare Form des lebendigen Lichts. Diese Lampenfamilie besteht aus geometrischen Strukturen, die von der Lichtquelle selbst gebildet werden. Unmerklich, fast ätherisch, materialisieren sich die Formen durch das Licht, die Lichtquellen sind es, die die Struktur bilden und das Volumen definieren. Der Effekt ist pure Lichtmagie. Der Strom zur Versorgung der LEDs fließt durch die Struktur. Euclide ist umweltfreundlich und benötigt ein Minimum an Energie und Materie für die Realisierung.

EUCLIDE

Forma impalpable de luz viva. Esta familia de lámparas se compone de estructuras geométricas formadas por la propia fuente de luz. Impalpables, casi etéreas, las formas se materializan con la luz, son las fuentes de luz las que componen la estructura y definen el volumen. El efecto es pura magia luminosa. La corriente para alimentar los LED atraviesa la estructura. Euclide es respetuosa con el medio ambiente y utiliza la mínima energía y materiales posibles para su realización.

EUCLIDE

Живой свет, облеченный в неосозаемую форму. Светильники этой серии представляют собой геометрические фигуры, являющиеся при этом источником освещения. Невесомые, почти эфирные формы материализуются благодаря свету, который формирует конструкцию и определяет объем. В результате рождается магия чистого света. Питающий светодиоды ток проходит через каркас. Euclide - это экологически чистое изделие, потребляющее минимум электроэнергии, а на его изготовление затрачивается минимальное количество сырья.



EUCLIDE SUSPENSION



EUCLIDE SUSPENSION



EUCLIDE SUSPENSION





EUCLIDE SUSPENSION



EUCLIDE SUSPENSION



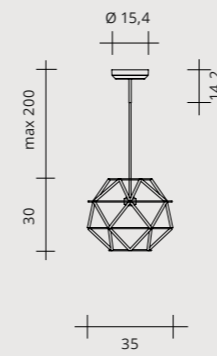

44W - 24V LED
2700°K / 2945 lumen
3000°K / 3273 lumen

Versions:

On-Off

Push

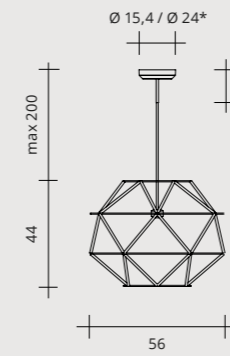

62W - 24V LED
2700°K / 4593 lumen
3000°K / 5104 lumen

Versions:

On-Off

* Push
Dali
0-10v
1-10v

* Triac

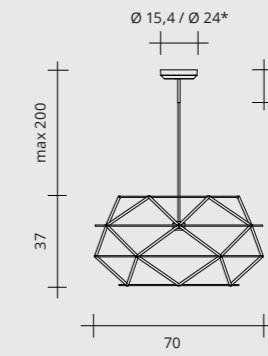

62W - 24V LED
2700°K / 4805 lumen
3000°K / 5339 lumen

Versions:

On-Off

* Push
Dali
0-10v
1-10v

* Triac

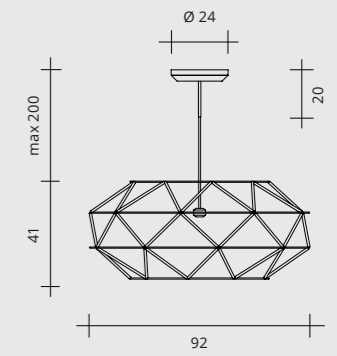

92W - 24V LED
2700°K / 7130 lumen
3000°K / 7922 lumen

Versions:

On-Off

Push
Dali
0-10v
1-10v

Triac

EUCLIDE Suspension lamp

Lampada a sospensione

Pendelleuchte

Lámpara colgante

Подвесной светильник



FINISHES / FINITURE / AUSFÜHRUNGEN / ACABADOS / ОТДЕЛКИ

● Matt black / Nero opaco / Mattschwarz / Negro mate / Матовый черный

● Gold / Oro / Gold / Oro / Золото

EUCLIDE CEILING





EUCLIDE CEILING

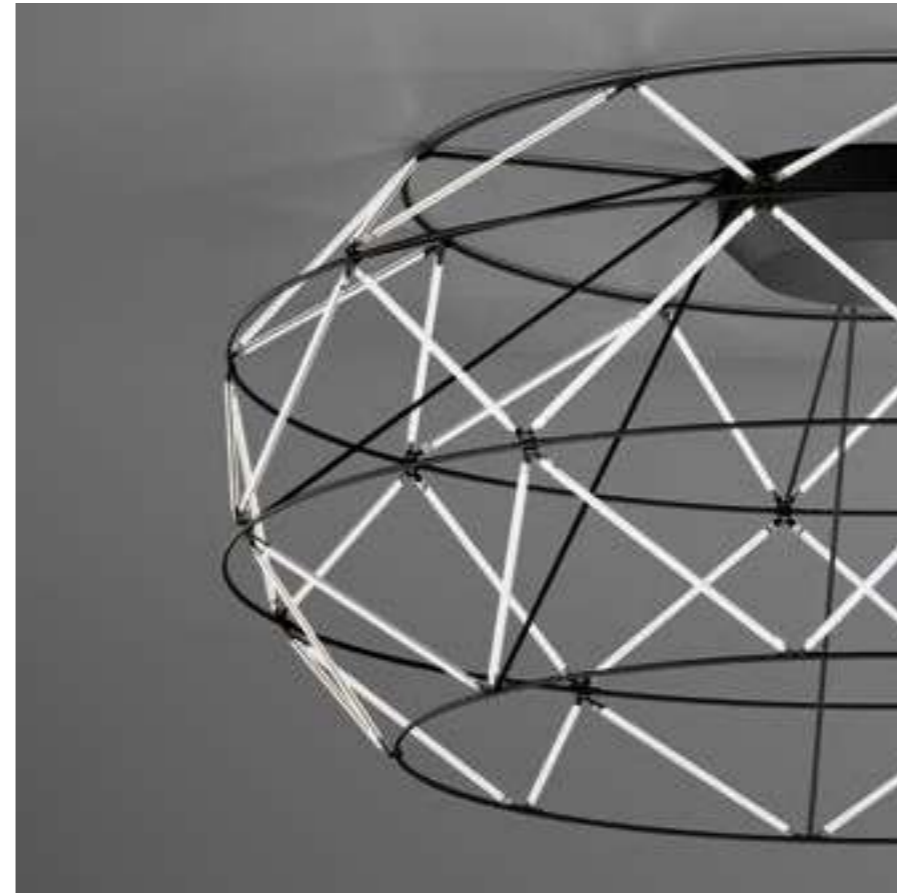

EUCLIDE CEILING





EUCLIDE CEILING



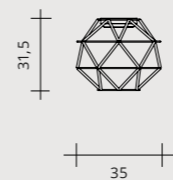

44W - 24V LED
2700°K / 2945 lumen
3000°K / 3273 lumen

Versions:

On-Off

Push

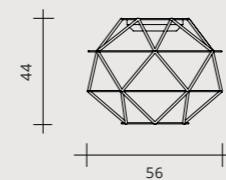

62W - 24V LED
2700°K / 4593 lumen
3000°K / 5104 lumen

Versions:

On-Off

Push
Dali
0-10v
1-10v

Triac

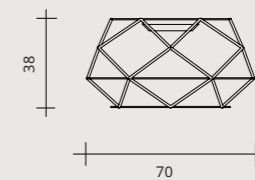

62W - 24V LED
2700°K / 4805 lumen
3000°K / 5339 lumen

Versions:

On-Off

Push
Dali
0-10v
1-10v

Triac

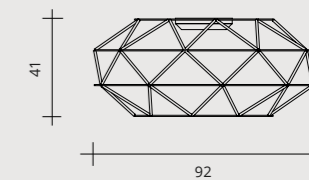

92W - 24V LED
2700°K / 7130 lumen
3000°K / 7922 lumen

Versions:

On-Off

Push
Dali
0-10v
1-10v

Triac

EUCLIDE Ceiling lamp

Lampada da soffitto
Deckenleuchte
Lámpara de techo
Потолочный светильник



FINISHES / FINITURE / AUSFÜHRUNGEN / ACABADOS / ОТДЕЛКИ

● Matt black / Nero opaco / Mattschwarz / Negro mate / Матовый черный

● Gold / Oro / Gold / Oro / Золото

EUCLIDE WALL

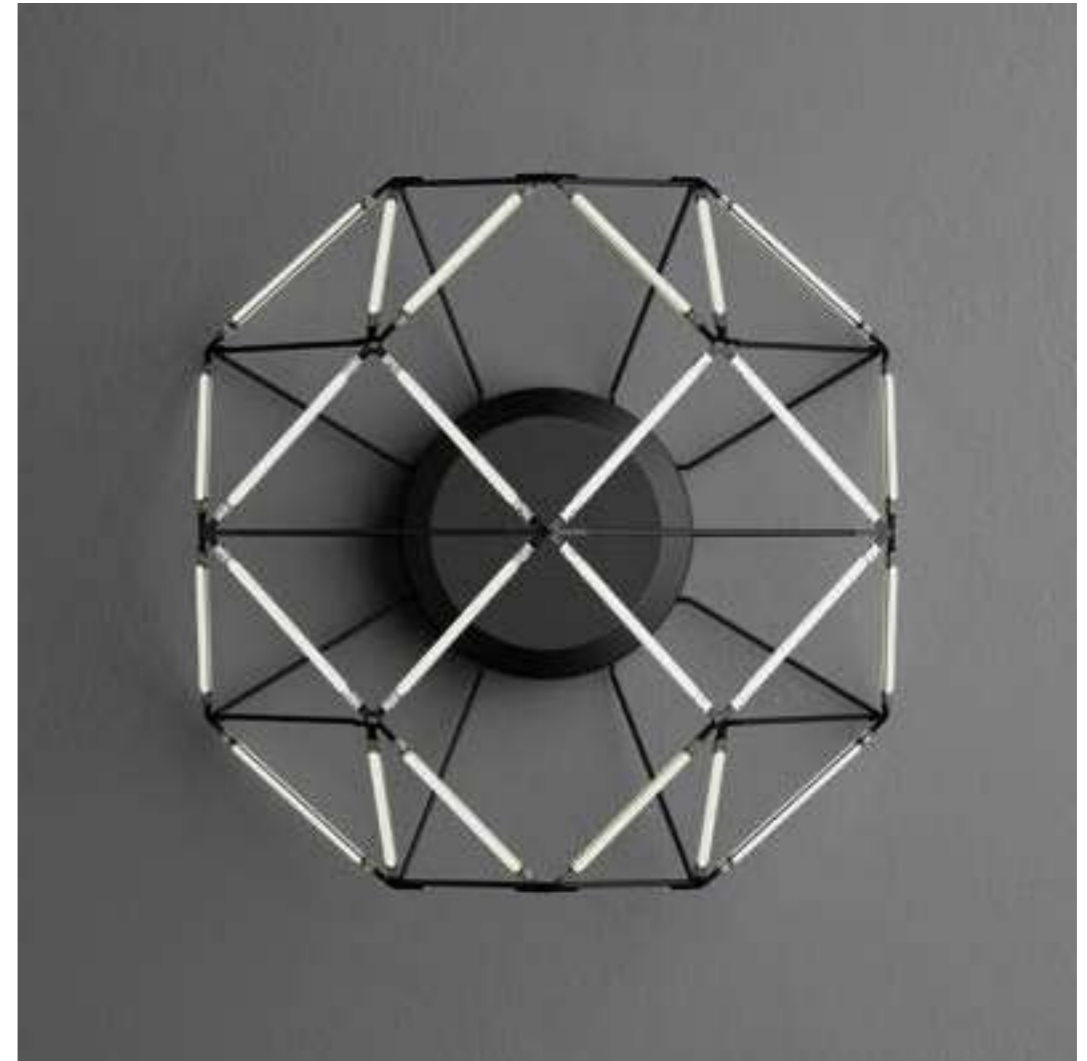
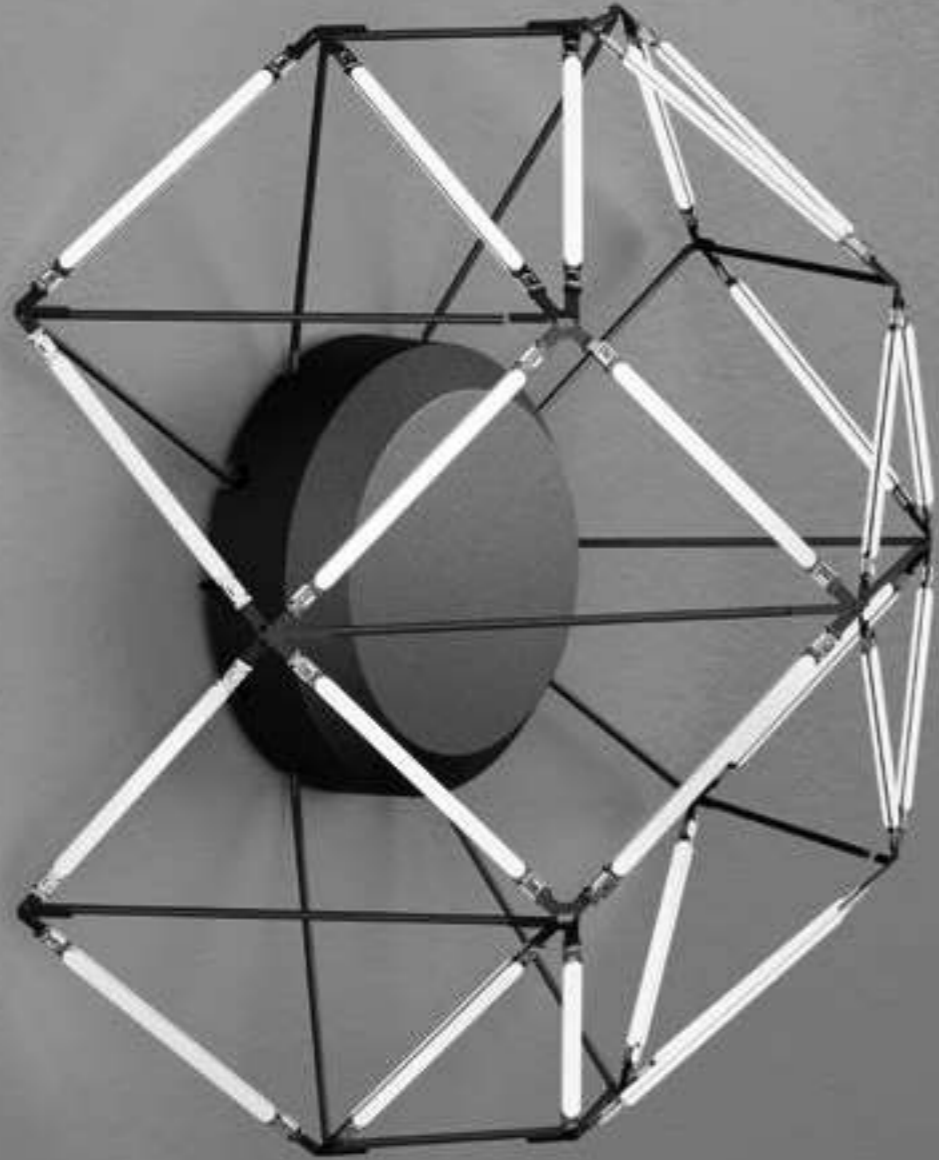

EUCLIDE WALL

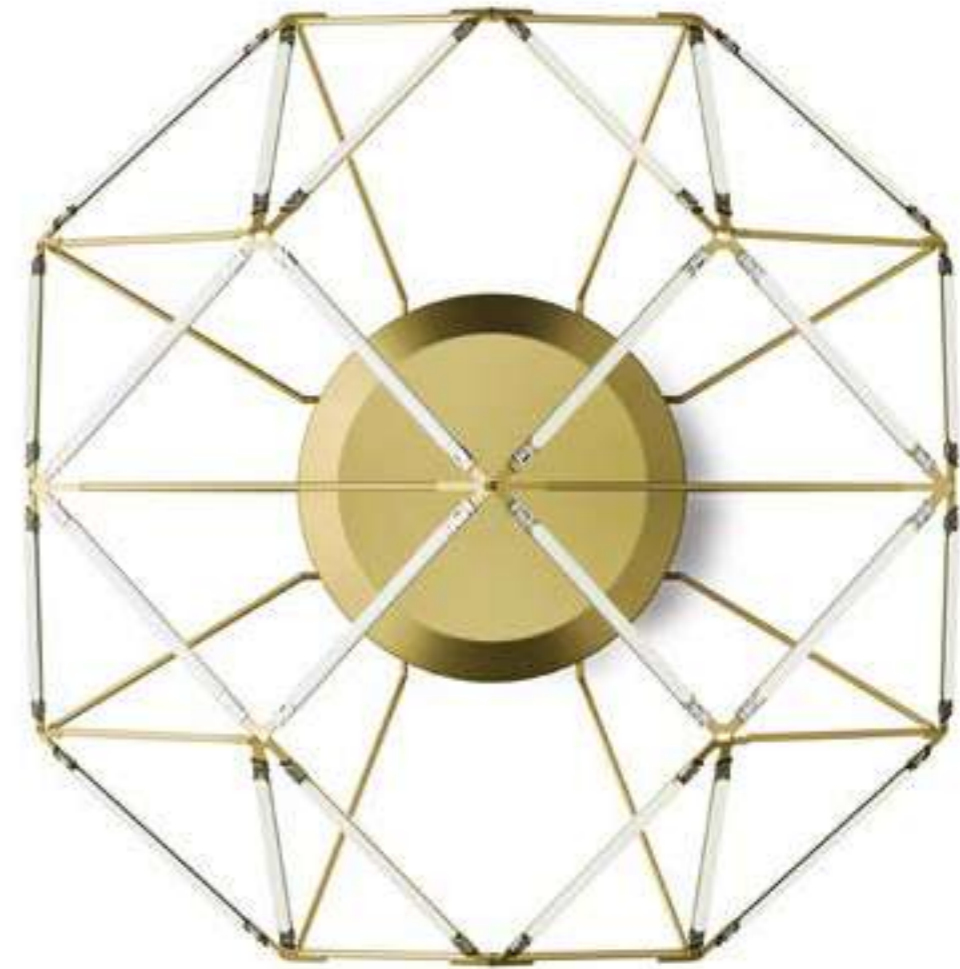

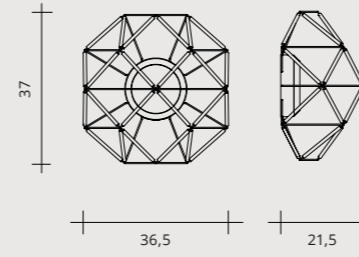

29W - 24V LED
2700°K / 1963 lumen
3000°K / 2181 lumen

Version:

On-Off

EUCLIDE

Wall lamp

Lampada da parete

Wandleuchte

Lámpara de pared

Настенный светильник



FINISHES / FINITURE / AUSFÜHRUNGEN / ACABADOS / ОТДЕЛКИ

● Matt black / Nero opaco / Mattschwarz / Negro mate / Матовый черный

● Gold / Oro / Gold / Oro / Золото



EUCLIDE FLOOR



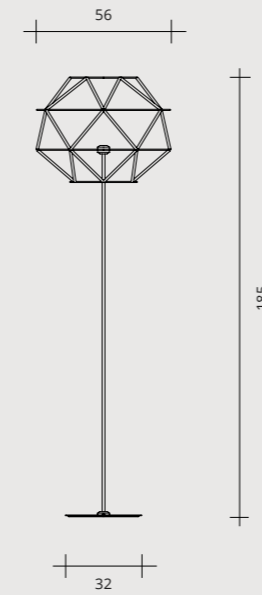

62W - 24V LED
2700°K / 4593 lumen
3000°K / 5104 lumen

*Footswitch dimmer included.
Dimmer a pedale incluso.
Inklusive Fußdimmer.
Regulador de intensidad con pedal incluido.
В комплект входит диммер с ножным управлением.*

EUCLIDE Floor lamp

*Lampada da terra.
Stehleuchte.
Lámpara de pie.
Напольная лампа.*



FINISHES / FINITURE / AUSFÜHRUNGEN / ACABADOS / ОТДЕЛКИ

- Matt black / Nero opaco / Mattschwarz / Negro mate / Матовый черный
- Gold / Oro / Gold / Oro / Золото

FILO

Marco Spatti

FILO

Under a new light.
The architecture of this product is characterised by the repetition of graphic signs around the central fulcrum. A sensual narrative through lines of light whose rhythm draws shapes in space, generates volumes permeable to the eye with lightness, elegance and style. An understated design that creates a luminous setting and enhances architectural spaces. A lighting concept whose identity was gained from the combination of memory and contemporary, to create hybrid and transverse non-chronological emotions.

FILO

Sotto un'altra luce. L'architettura del prodotto è caratterizzata dalla ripetizione di segni grafici intorno al fulcro centrale. Una narrazione sensuale attraverso linee di luce il cui ritmo disegna forme nello spazio, genera volumi permeabili alla vista con leggerezza, eleganza e stile. Un design sobrio che crea scenografia luminosa e valorizza gli spazi architettonici. Un concetto di illuminazione che ha una identità acquisita dalla combinazione di memoria e contemporaneo per creare emozioni ibride e trasversali non cronologiche.

FILO

In einem anderen Licht. Die Architektur des Produkts ist durch die Wiederholung der grafischen Zeichen um den zentralen Drehpunkt gekennzeichnet. Eine sinnliche Erzählung durch Lichtlinien, deren Rhythmus Formen in den Raum zeichnet, erzeugt Volumen, die mit Leichtigkeit, Eleganz und Stil für das Auge durchlässig sind. Ein unaufdringliches Design, das eine leuchtende Umgebung schafft und architektonische Räume aufwertet. Ein Beleuchtungskonzept, das eine Identität hat, die aus der Kombination von Erinnerung und Zeitgenössischem entsteht, um hybride und transversale nicht-chronologische Emotionen zu schaffen.

FILO

Desde otro punto de luz. La arquitectura del producto se caracteriza por la repetición de signos gráficos en torno al eje central. Una narrativa sensual a través de líneas de luz cuyo ritmo dibuja formas en el espacio, genera volúmenes permeables a la vista con ligereza, elegancia y estilo. Un diseño discreto que crea un entorno luminoso y realza los espacios arquitectónicos. Un concepto de iluminación que tiene una identidad que nace de la combinación de la memoria y estilo contemporáneo para crear emociones híbridas y transversales no cronológicas.

FILO

В ином свете. Дизайн изделия основан на повторяющихся графических знаках, кольцом охватывающих центральную часть. Чувственный образ, сотканный из световых контуров, чей ритм создает в пространстве формы и прозрачные объемы под знаком легкости, элегантности и стиля. Сдержанный дизайн, создающий атмосферу, полную света, и выгодно подчеркивающий интерьерное пространство. Концепция освещения, имеющая собственный неповторимый облик, который складывается из сочетания винтажных и современных элементов, создавая многогранные, «сквозные», вневременные эмоции.





FILO SUSPENSION

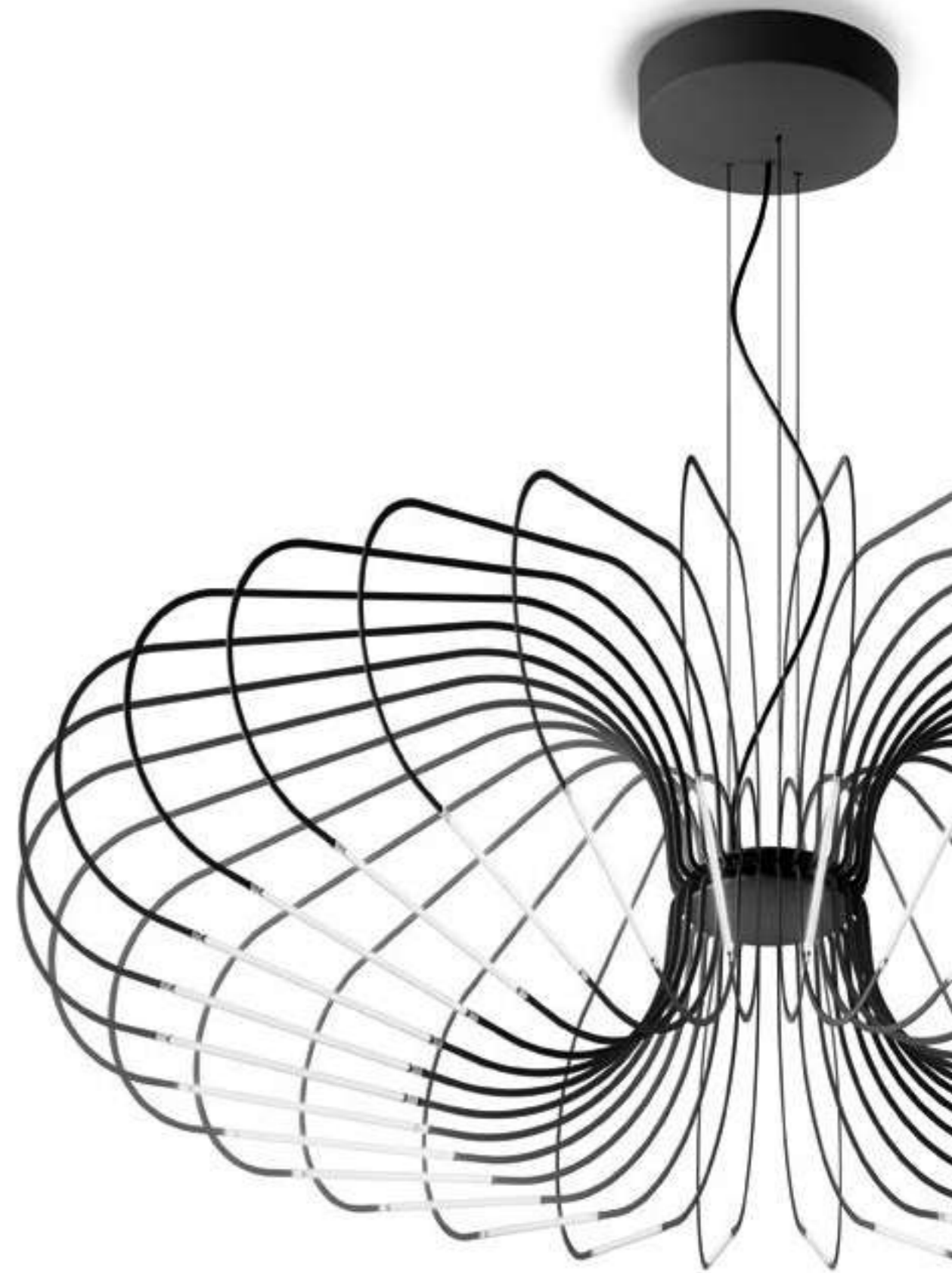

FILO SUSPENSION

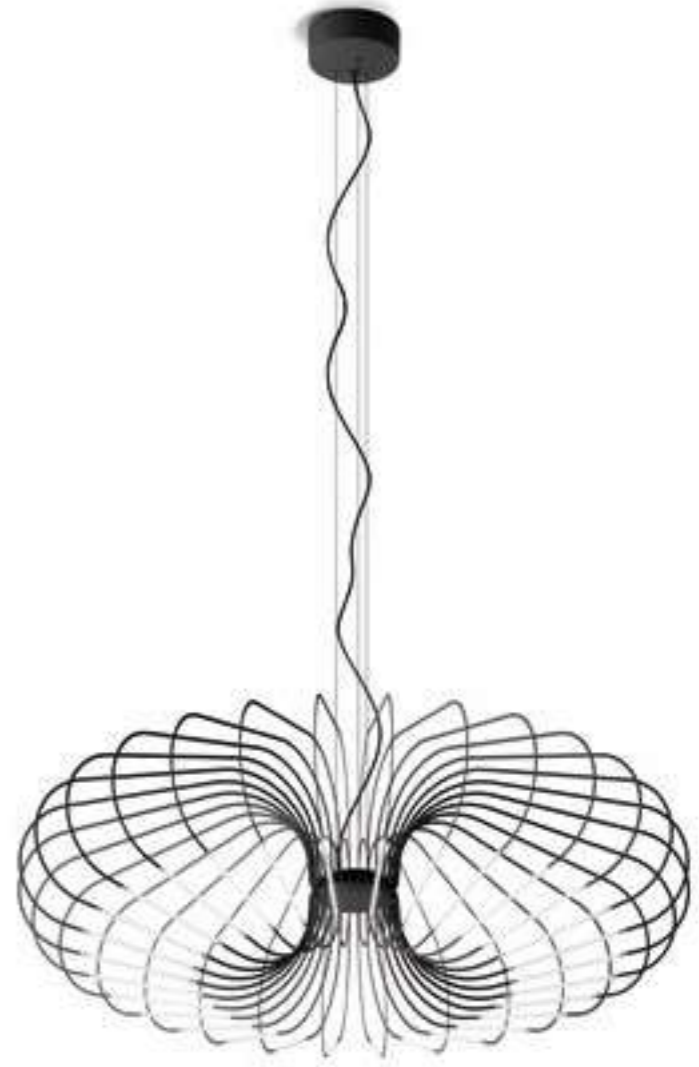
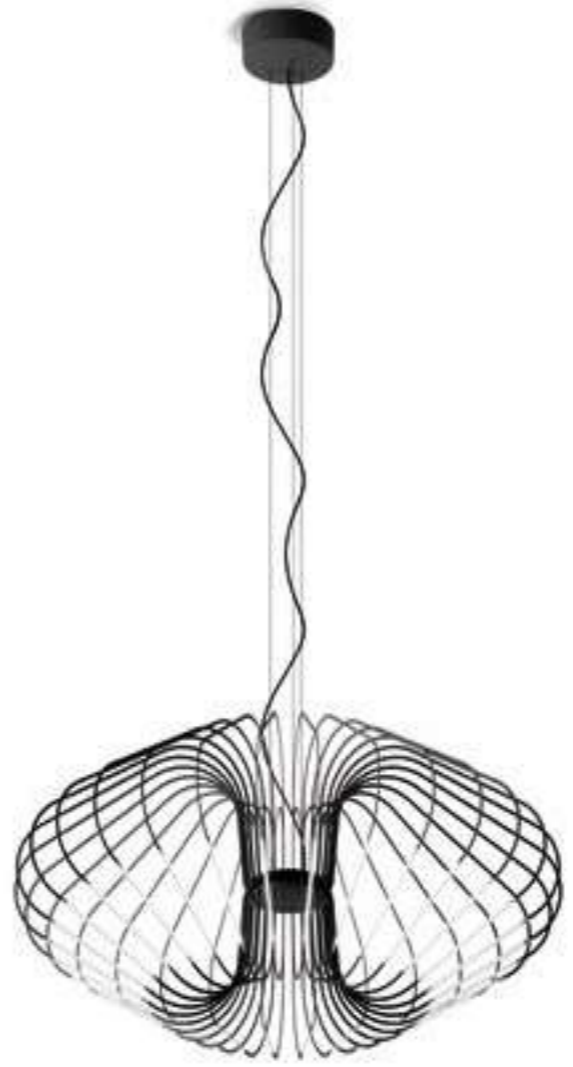
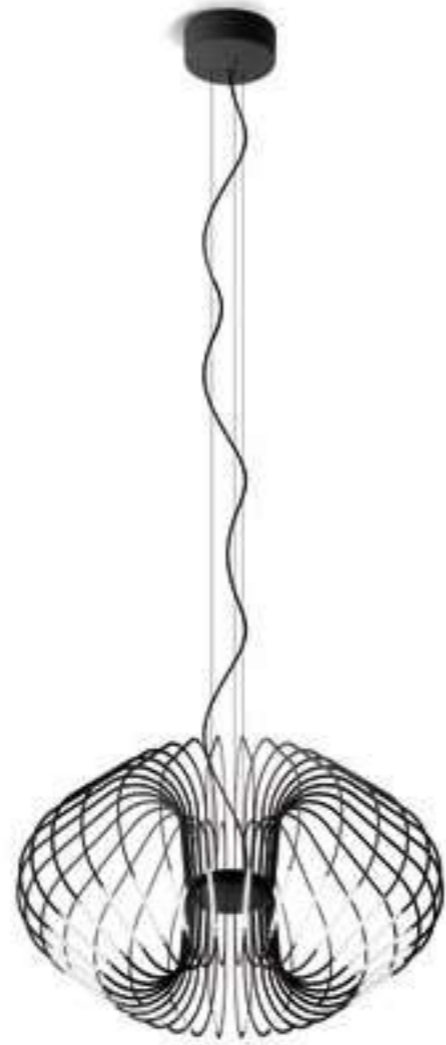
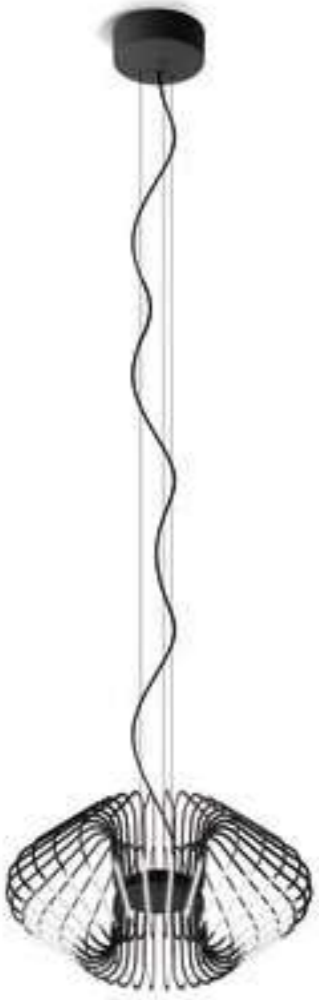



FILO SUSPENSION

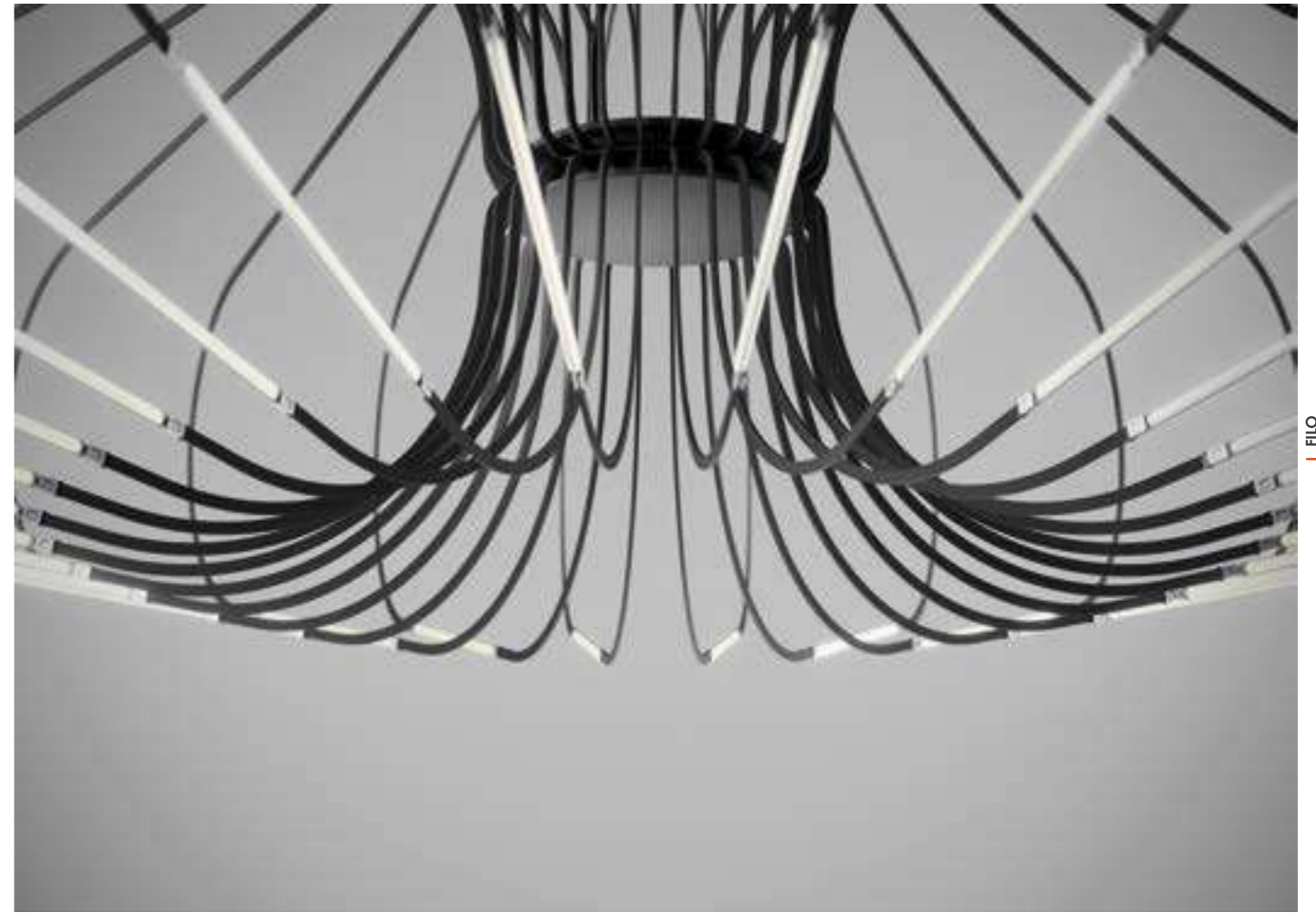

FILO SUSPENSION



FILO SUSPENSION



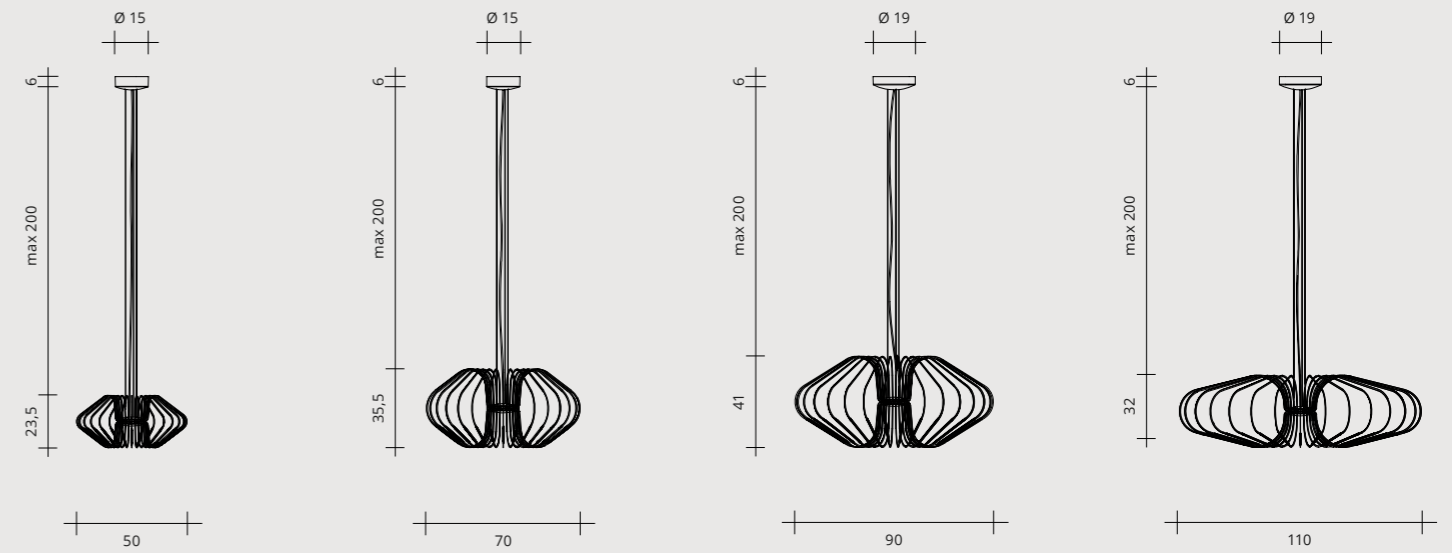

36W - 24V LED
2700°K / 2460 lumen
3000°K / 2750 lumen

Versions:

On-Off

Push
Dali
0-10v
1-10v

36W - 24V LED
2700°K / 2460 lumen
3000°K / 2750 lumen

Versions:

On-Off

Push
Dali
0-10v
1-10v

51W - 24V LED
2700°K / 4568 lumen
3000°K / 5076 lumen

Versions:

On-Off

Push
Dali
0-10v
1-10v

Triac

51W - 24V LED
2700°K / 4568 lumen
3000°K / 5076 lumen

Versions:

On-Off

Push
Dali
0-10v
1-10v

Triac

FILO Suspension lamp

Lampada a sospensione
Pendelleuchte
Lámpara colgante
Подвесной светильник



FINISHES / FINITURE / AUSFÜHRUNGEN / ACABADOS / ОТДЕЛКИ

- Matt powder pink / Cipria opaco / Puderrosa matt / Rosa palo mate / Пудровый матовый
- Titanium / Titanio / Titan / Titanio / Титан



FILO CEILING

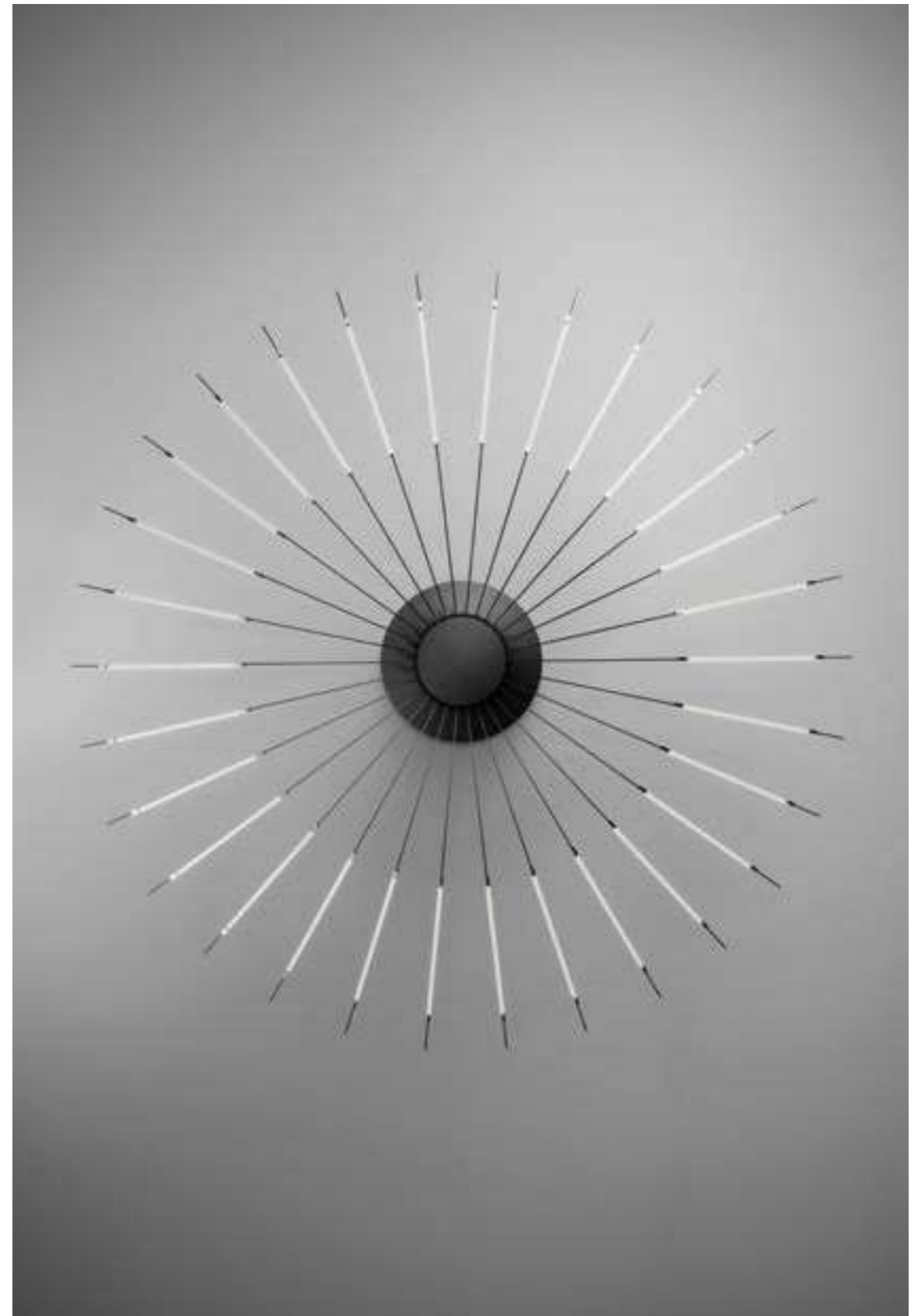

FILO CEILING

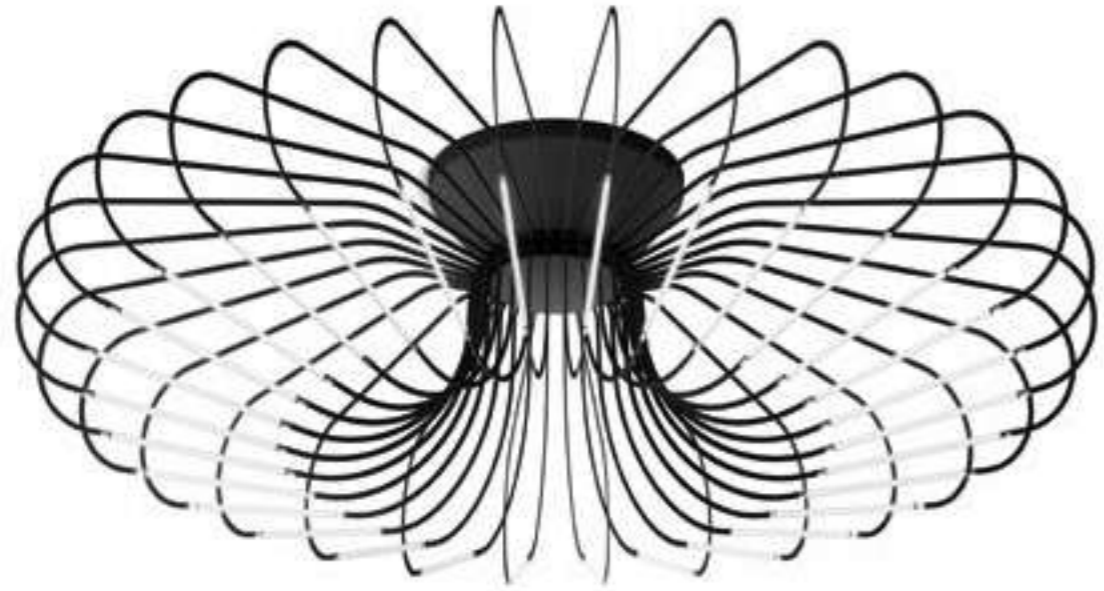



FILO CEILING

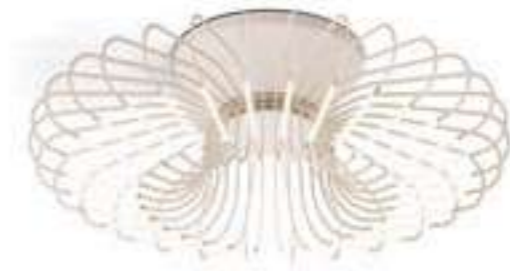

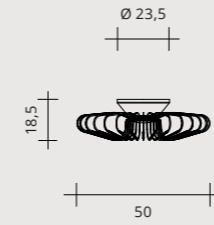

36W - 24V LED
2700°K / 2460 lumen
3000°K / 2750 lumen

Versions:

On-Off

Push
Dali
0-10v
1-10v

Triac

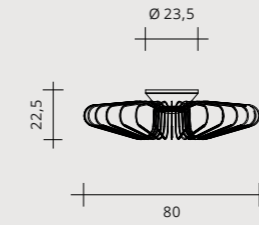

51W - 24V LED
2700°K / 4568 lumen
3000°K / 5076 lumen

Versions:

On-Off

Push
Dali
0-10v
1-10v

Triac

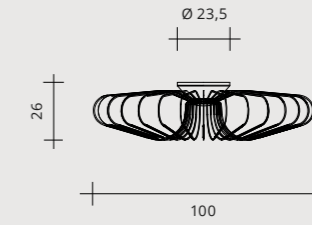

51W - 24V LED
2700°K / 4568 lumen
3000°K / 5076 lumen

Versions:

On-Off

Push
Dali
0-10v
1-10v

Triac

FILO Ceiling lamp

Lampada da soffitto
Deckenleuchte
Lámpara de techo
Потолочный светильник



FINISHES / FINITURE / AUSFÜHRUNGEN / ACABADOS / ОТДЕЛКИ

- Matt powder pink / Cipria opaco / Puderrosa matt / Rosa palo mate / Пудровый матовый
- Titanium / Titanio / Titan / Titanio / Титан

CARTESIAN

Gerardo Mari

CARTESIAN

Technique, expressiveness, pure contemporary energy. This lighting system consists of light modules connected to one another through elements fixed to the wall, the ceiling or suspended. The connection bases can connect up to 4 different modules in a linear or 90° layout, to create paths, different Cartesian geometries and light grids. Simply attach the connection bases so that the light modules can interlock. Only the first connection base needs to be powered, the rest of the current passes through the light modules.

CARTESIAN

Tecnica, espressività, pura energia contemporanea. È un sistema di illuminazione composto da moduli di luce che si collegano tra di loro con elementi di connessione fissati al muro, al soffitto o sospesi. Le basi di connessione collegano fino a 4 moduli diversi in modo lineare o a 90°, permettendo di creare percorsi, geometrie cartesiane diverse e griglie di luce. È sufficiente fissare le basi di connessione perché i moduli di luce si colleghino a incastro. Soltanto una prima base di connessione ha bisogno di essere alimentata, il resto della corrente passa attraverso i moduli di luce.

CARTESIAN

Technik, Ausdruckskraft, pure zeitgenössische Energie. Es handelt sich um ein Beleuchtungssystem, das aus Lichtmodulen besteht, die sich miteinander dank Verbindungselementen, die an der Wand oder der Decke befestigt oder aufgehängt sind, miteinander verbinden. Die Verbindungssockel verbinden bis zu 4 verschiedene Module linear oder um 90° versetzt und ermöglichen die Erstellung von Pfaden, verschiedenen kartesischen Geometrien und Lichtgittern. Einfach die Verbindungssockel so anbringen, dass die Lichtmodule sich verzahnen. Nur der erste Verbindungssockel muss mit Strom versorgt werden, der Rest des Stromes fließt durch die Lichtmodule.

CARTESIAN

Técnica, expresividad, pura energía contemporánea. Es un sistema de iluminación compuesto por módulos luminosos que se conectan entre sí con elementos de unión fijados a la pared, al techo o suspendidos. Las bases de conexión conectan hasta 4 módulos diferentes de forma lineal o a 90°, lo que permite crear recorridos, distintas geometrías cartesianas y rejillas de luz. Basta con colocar las bases de conexión de modo que los módulos luminosos encajen. Solo es necesario alimentar la primera base de conexión, el resto de la corriente pasa a través de los módulos de luz.

CARTESIAN

Техничность, экспрессия, яркая современная энергия. Эта система освещения состоит из световых модулей, которые соединяются друг с другом с помощью элементов, крепящихся к стене или к потолку либо подвесных. Соединительные основания обеспечивают соединение до 4 различных модулей, которое может быть линейным или располагаться под углом 90°. Это позволяет создавать различные конфигурации, композиции из геометрических фигур и световые сетки. Чтобы обеспечить взаимное сцепление световых модулей, достаточно закрепить соединительные основания. В подаче питания нуждается лишь первое соединительное основание: далее ток проходит через световые модули.

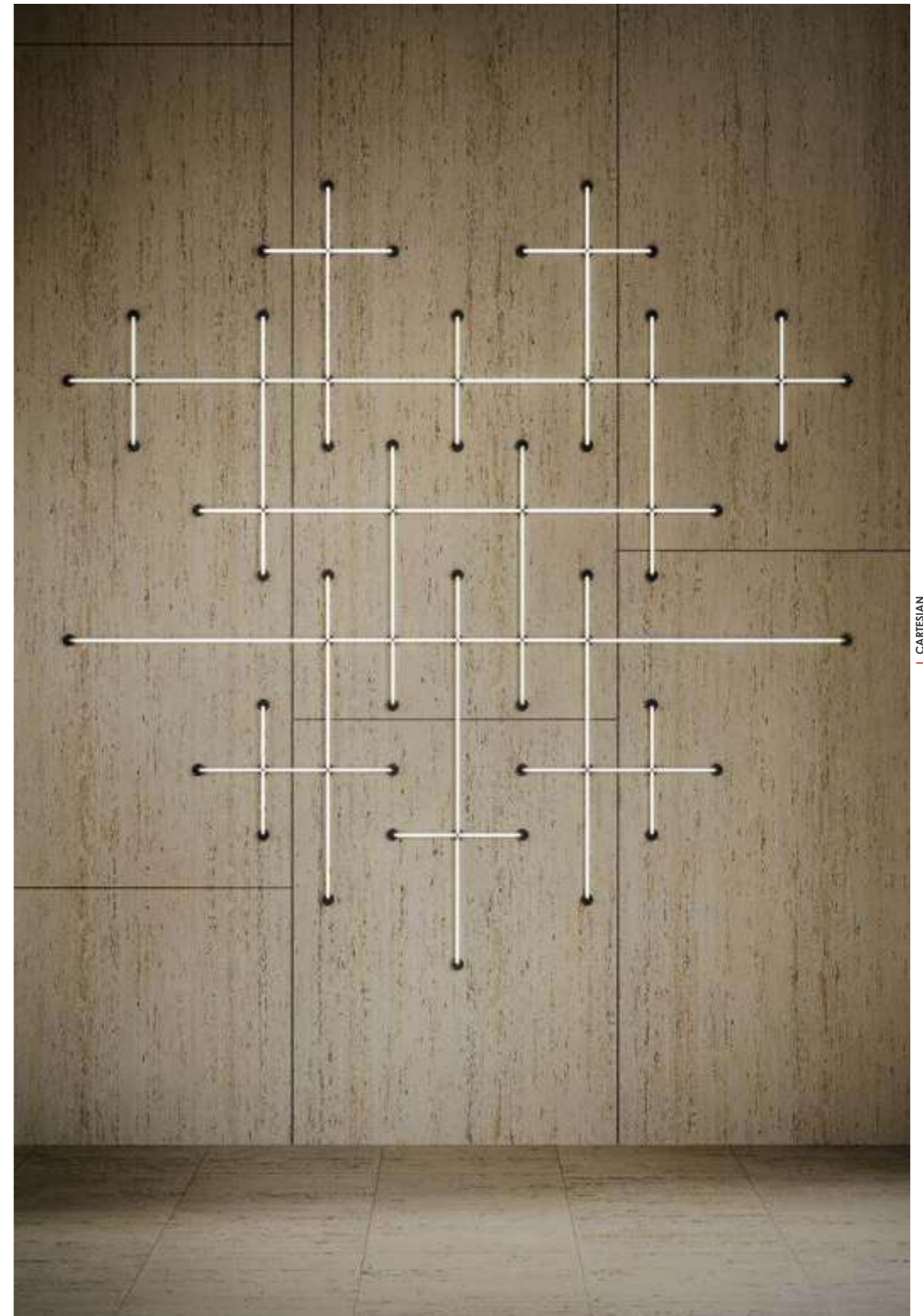

CARTESIAN

SURFACE MOUNTING



CARTESIAN

SURFACE MOUNTING



CARTESIAN

SURFACE MOUNTING



CARTESIAN SURFACE MOUNTING



CARTESIAN

SURFACE MOUNTING

CARTESIAN Surface mounting

Modular lighting system
Sistema d'illuminazione modulare
Modulares Beleuchtungssystem
Sistema de iluminación modular
Модульная система освещения

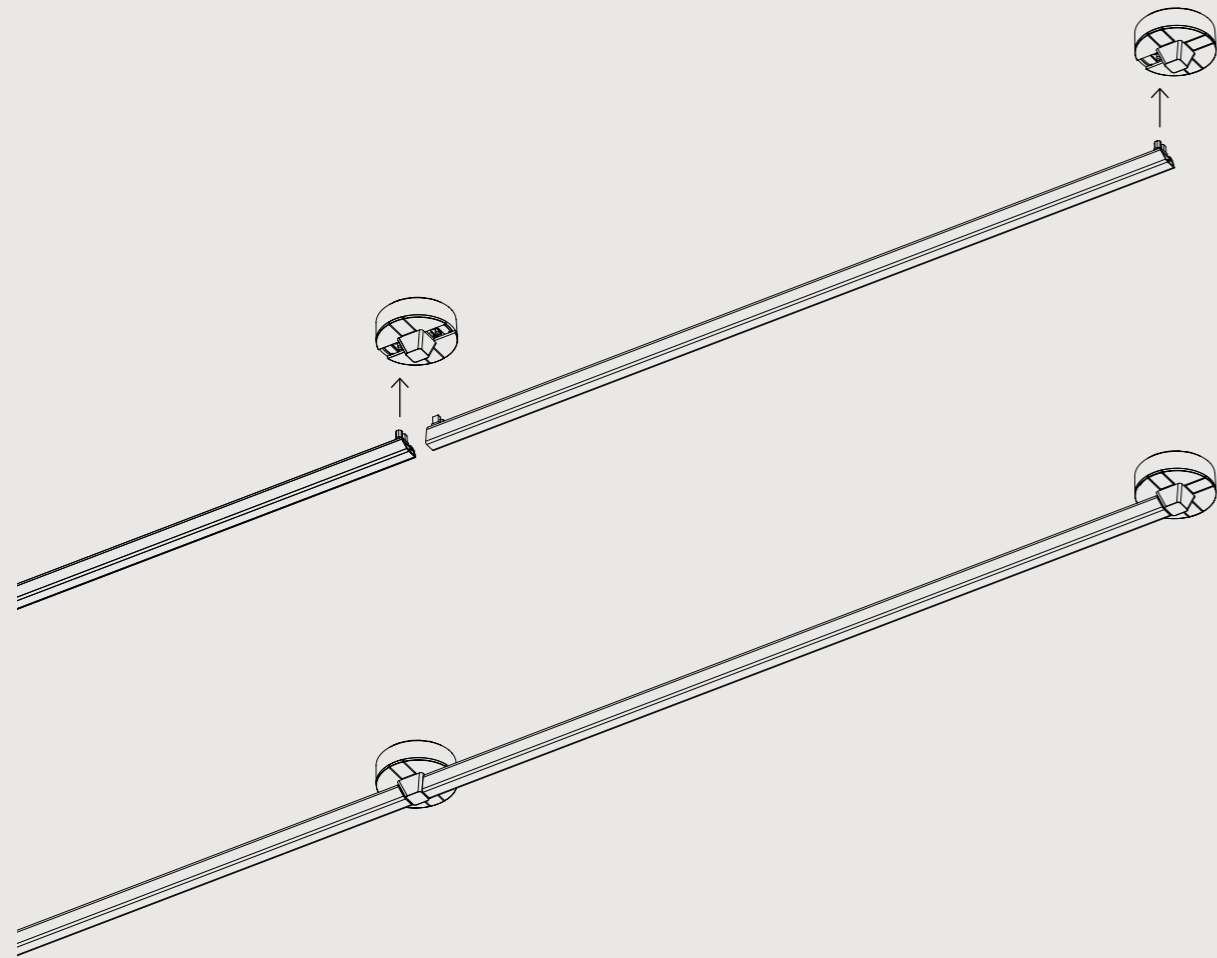
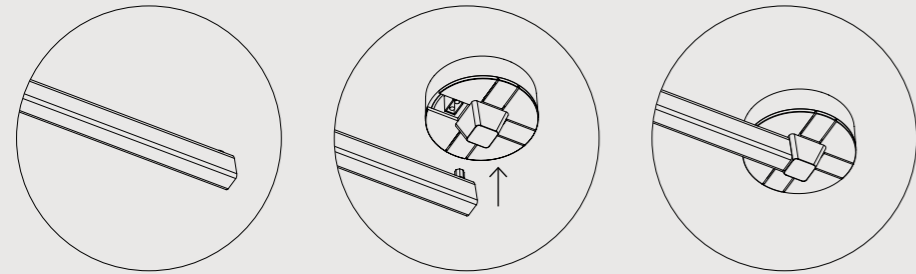

Configurations available

Possibili configurazioni / Mögliche Konfigurationen / Posibles configuraciones / Возможные конфигурации

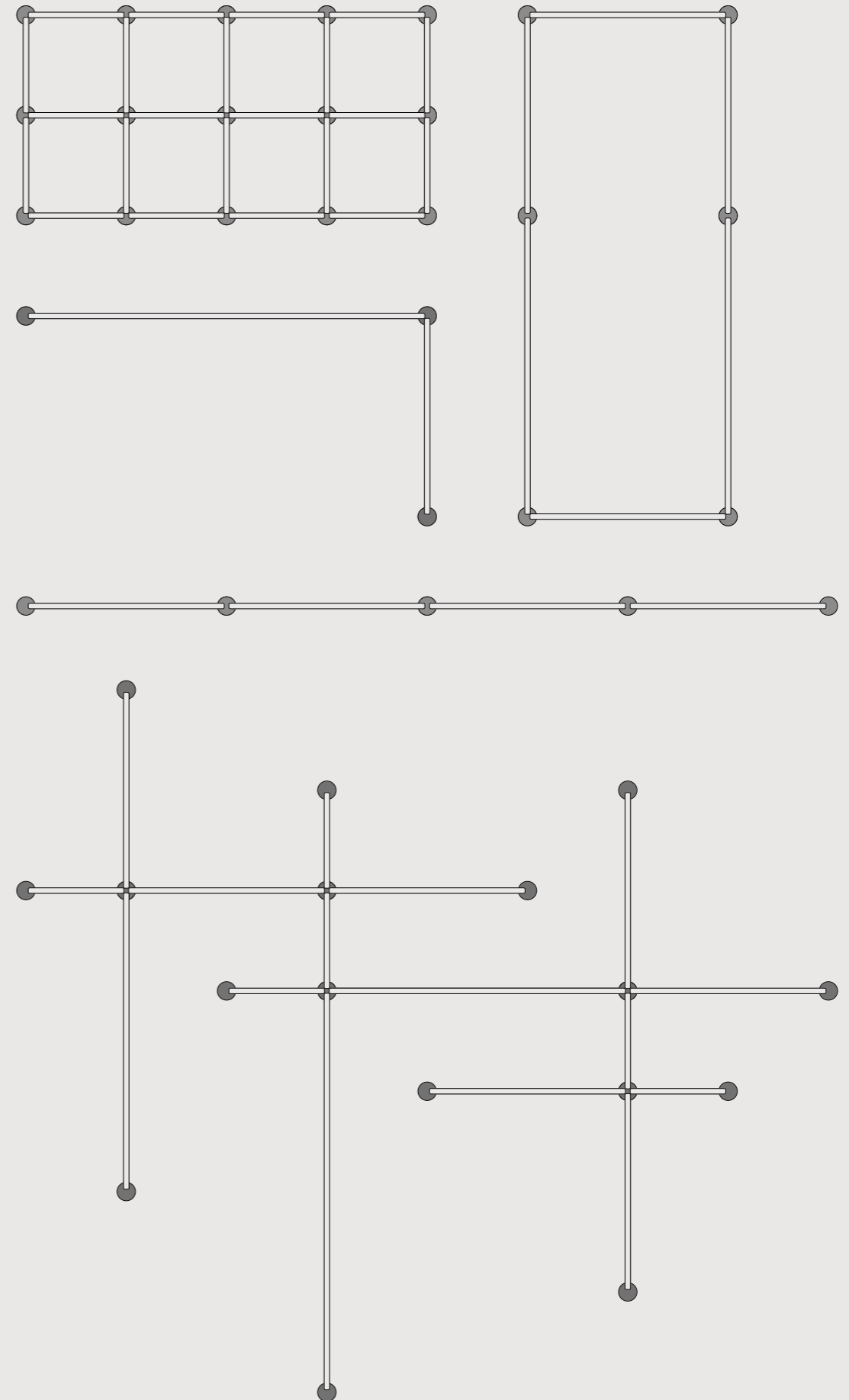

CARTESIAN

Surface mounting

Modular lighting system
 Sistema d'illuminazione modulare
 Modulares Beleuchtungssystem
 Sistema de iluminación modular
 Модульная система освещения



FINISHES / FINITURE / AUSFÜHRUNGEN / ACABADOS / ОТДЕЛКИ

CONNECTORS, DRIVER BOX

Connettori, driver box / Steckverbinder, Treiberboxen /
 Conectores, cajas de controladores / Коннекторы, Коннекторы, коробки для драйверов

● Black / Nero / Schwarz / Negro / Черный

LIGHT MODULE

Modulo luce / Lichtmodul / Módulo de luz / Световой модуль

● White opal polycarbonate / Policarbonato bianco opale / Weißes opales Polycarbonat /
 Policarbonato blanco opalino / Поликарбонат опаловый белый

LIGHT SOURCE / SORGENTE / LICHTQUELLE / FUENTE LUMINOSA / ИСТОЧНИК СВЕТА

30 cm.	LED 5W	24V	2700°K / 590 Lumen 3000°K / 656 Lumen	CRI 90 CRI 90
60 cm.	LED 10W	24V	2700°K / 1171 Lumen 3000°K / 1302 Lumen	CRI 90 CRI 90
90 cm.	LED 15W	24V	2700°K / 1661 Lumen 3000°K / 1846 Lumen	CRI 90 CRI 90
120 cm.	LED 20W	24V	2700°K / 2354 Lumen 3000°K / 2616 Lumen	CRI 90 CRI 90

MODULE / MODULO / MODUL / MÓDULO / МОДУЛЬ

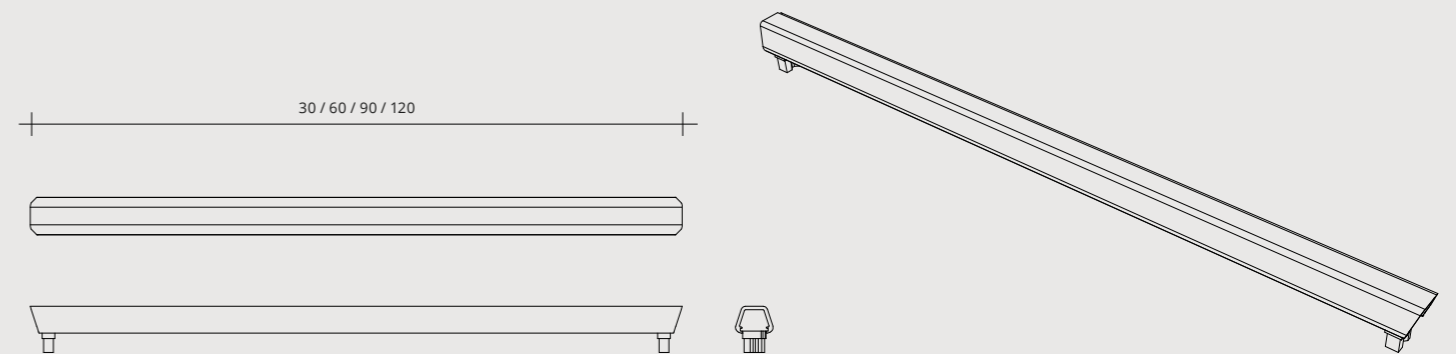

CONNECTOR / CONNETTORE / VERBINDUNGSTEIL / CONECTOR / КОННЕКТОР

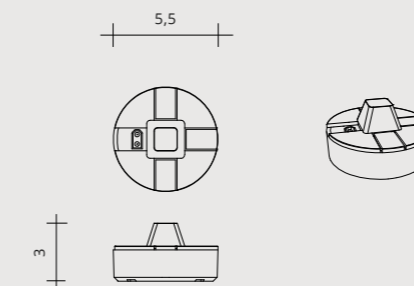

DRIVER BOX

On-Off
 up to 200W

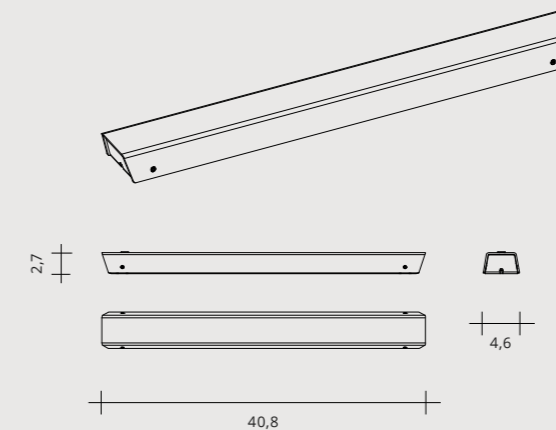

DRIVER BOX

Dimmer
 (dali / push / 0-10V / 1-10V)
 up to 200W

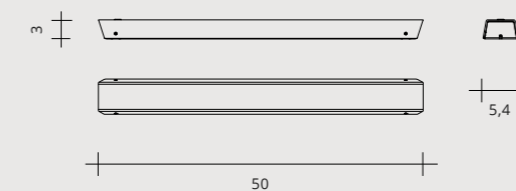

CARTESIAN SUSPENSION



CARTESIAN SUSPENSION



CARTESIAN SUSPENSION

CARTESIAN

Surface mounting

Modular lighting system
 Sistema d'illuminazione modulare
 Modulares Beleuchtungssystem
 Sistema de iluminación modular
 Модульная система освещения



FINISHES / FINITURE / AUSFÜHRUNGEN / ACABADOS / ОТДЕЛКИ

CONNECTORS, DRIVER BOX

Connettori, driver box / Steckverbinder, Treiberboxen /
 Conectores, cajas de controladores / Коннекторы, коробки для драйверов

● Black / Nero / Schwarz / Negro / Черный

LIGHT MODULE

Modulo luce / Lichtmodul / Módulo de luz / Световой модуль

● White opal polycarbonate / Policarbonato bianco opale / Weißes opales Polycarbonat /
 Policarbonato blanco opalino / Поликарбонат опаловый белый

LIGHT SOURCE / SORGENTE / LICHTQUELLE / FUENTE LUMINOSA / ИСТОЧНИК СВЕТА

30 cm.	LED 5W	24V	2700°K / 590 Lumen 3000°K / 656 Lumen	CRI 90 CRI 90
60 cm.	LED 10W	24V	2700°K / 1171 Lumen 3000°K / 1302 Lumen	CRI 90 CRI 90
90 cm.	LED 15W	24V	2700°K / 1661 Lumen 3000°K / 1846 Lumen	CRI 90 CRI 90
120 cm.	LED 20W	24V	2700°K / 2354 Lumen 3000°K / 2616 Lumen	CRI 90 CRI 90

MODULE / MODULO / MODUL / MÓDULO / МОДУЛЬ

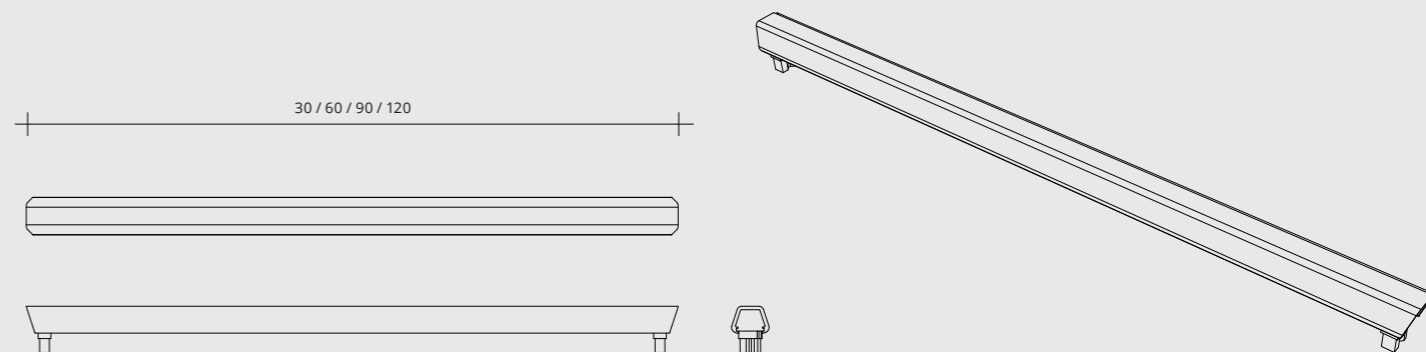

CONNECTOR / CONNETTORE / VERBINDUNGSTEIL / CONECTOR / КОННЕКТОР

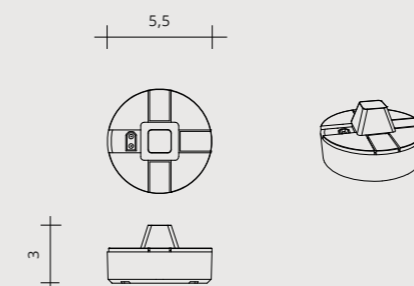

DRIVER BOX

On-Off
 up to 200W

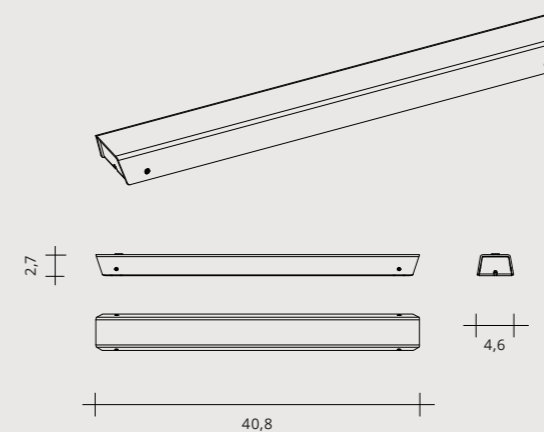

DRIVER BOX

Dimmer
 (dali / push / 0-10V / 1-10V)
 up to 200W

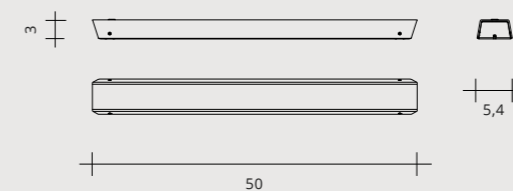

Go to the page(s) specified for codes and prices / Vedi codici e prezzi da pag a pag. / Artikelnummern und Preise siehe Seite bis Seite
 Véanse los códigos y precios desde pag. hasta pag. / См. постраничную информацию о кодах и ценах

321 - 322

EG

Moon and star.
A ceiling light that conveys the discreet charm of rigorous minimal elegance, redefining the essential features of lighting comfort with a timeless design. This is Eg. Refined, discreet, soft and cosy, it looks like a porthole in the ceiling through which natural diffuse light passes. An idea of elegance and lightness that harmoniously expresses form and discretion, on which light is modelled as a protagonist, opening up new spaces.



EG

Luna e stella.
Una plafoniera che sa raccontare il fascino discreto della rigorosa eleganza minimale, ridisegnando i tratti essenziali del comfort dell'illuminazione con un design senza tempo.
Questa è Eg. Raffinata, discreta, morbida e accogliente, si presenta come un oblò sul soffitto da cui passa luce diffusa naturale.
Un'idea di eleganza e leggerezza che esprime in modo armonico, forma e discrezione, sulle quali si modella da protagonista la luce, che apre nuovi spazi.

EG

Mond und Stern.
Eine Deckenleuchte, die den diskreten Charme einer strengen, minimalen Eleganz ausstrahlt und die wesentlichen Merkmale des Beleuchtungskomforts mit einem zeitlosen Design neu definiert.
Das ist Eg. Raffiniert, diskret, weich und gemütlich wirkt sie wie ein Bullauge in der Decke, durch das natürliches, diffuses Licht fällt.
Eine Idee von Eleganz und Leichtigkeit, die Form und Diskretion harmonisch zum Ausdruck bringt, bei der das Licht als Protagonist fungiert und neue Räume eröffnet.

EG

Luna y estrella.
Lámpara de techo que transmite el discreto encanto de una rigurosa elegancia minimalista, redefiniendo las características esenciales del confort lumínico con un diseño atemporal.
Así es Eg. Elegante, discreta, delicada y acogedora, como un ojo de buey colocado en el techo por el que pasa la luz natural difusa.
Una idea de elegancia y ligereza que expresa armoniosamente forma y discreción, en la que la luz se modela como protagonista para abrir nuevos espacios.

EG

Луна и звезда.
Потолочный светильник, который олицетворяет сдержанное очарование строгой и минималистичной элегантности: новая интерпретация основных качеств комфортного освещения под знаком вневременного дизайна.
Все это - светильник Eg. Изысканный, неброский, мягкий и уютный светильник напоминает иллюминатор в потолке, через который льется естественный рассеянный свет.
Идея элегантности и легкости, гармоничным образом воплощенная в лаконичности форм, над которыми безраздельно властвует свет, распахивающий новые пространства.



EG WALL | CEILING







EG WALL | CEILING



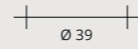
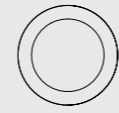

33W LED
3000°K / 1664 lumen

Version:

On-Off

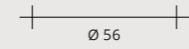
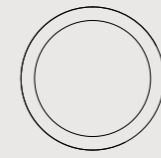
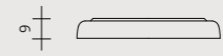

42W LED
3000°K / 2585 lumen

Version:

On-Off

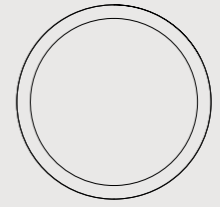
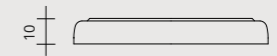

63W LED
3000°K / 3850 lumen

Version:

On-Off

EG

Wall | Ceiling lamp

Lampada da soffitto e parete

Wand- und Deckenleuchten

Lámpara de techo y de pared

Потолочный и настенный светильник



FINISHES / FINITURE / AUSFÜHRUNGEN / ACABADOS / ОТДЕЛКИ

- White / Bianco / Weiß / Blanco / Белый
- Dove grey / Tortora / Taubengrau / Gris paloma / Таян
- Dark grey / Grigio scuro / Dunkelgrau / Gris oscuro / Темно-серый

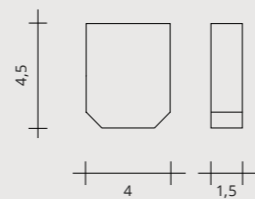

OPTIONAL

DIM001:

Phase-cut dimmer

Dimmer a taglio di fase

Phasenanschnitt-Dimmer

Regulador de intensidad con corte de fase

Диммер с отсечкой фазы

ANELLO

SUSPENSION

Urban Design Team

ANELLO

The purest form in its minimal interpretation. A perfect suspended circle, described in space by a thin aluminium body. A continuous, discrete internal thread of light that illuminates the environment evenly. Dimmable version available.

ANELLO

La forma più pura nella sua declinazione minima. Un cerchio perfetto sospeso, descritto nello spazio da un sottile corpo in alluminio. Un filo continuo, discreto, di luce interno che illumina l'ambiente in modo uniforme. Disponibile anche in versione dimmerabile.

ANELLO

Die reinste Form in ihrer minimalen Deklination. Ein schwebender perfekter Kreis, beschrieben im Raum durch ein dünnes Aluminiumgehäuse. Ein kontinuierlicher, diskreter Faden inneren Lichtes, das den Raum gleichmäßig beleuchtet. Auch eine dimmbare Version ist verfügbar.

ANELLO

La forma más pura en su mínima representación. Un círculo perfecto suspendido, dibujado en el espacio por un sutil cuerpo de aluminio. Un hilo continuo, discreto, de luz interior que ilumina el ambiente de manera uniforme. Disponible también en versión regulable.

ANELLO

Чистейшая форма в ее минималистичном воплощении. Безупречный круг, парящий в пространстве и очерченный тонким алюминиевым корпусом. Тонкая непрерывная струя благородного света внутри круга равномерно освещает помещение. Также имеется диммируемая версия.



ANELLO CEILING

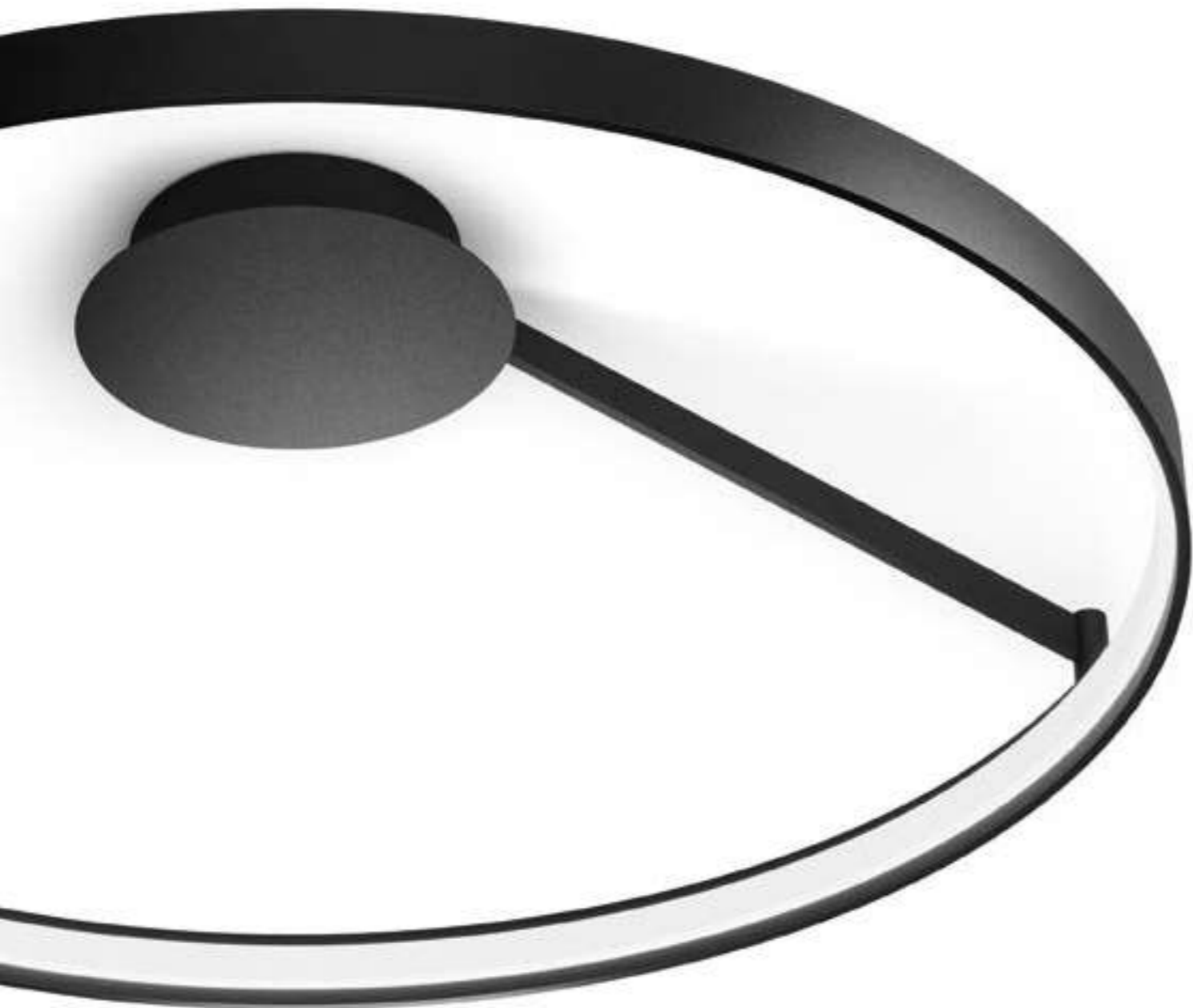

ANELLO CEILING

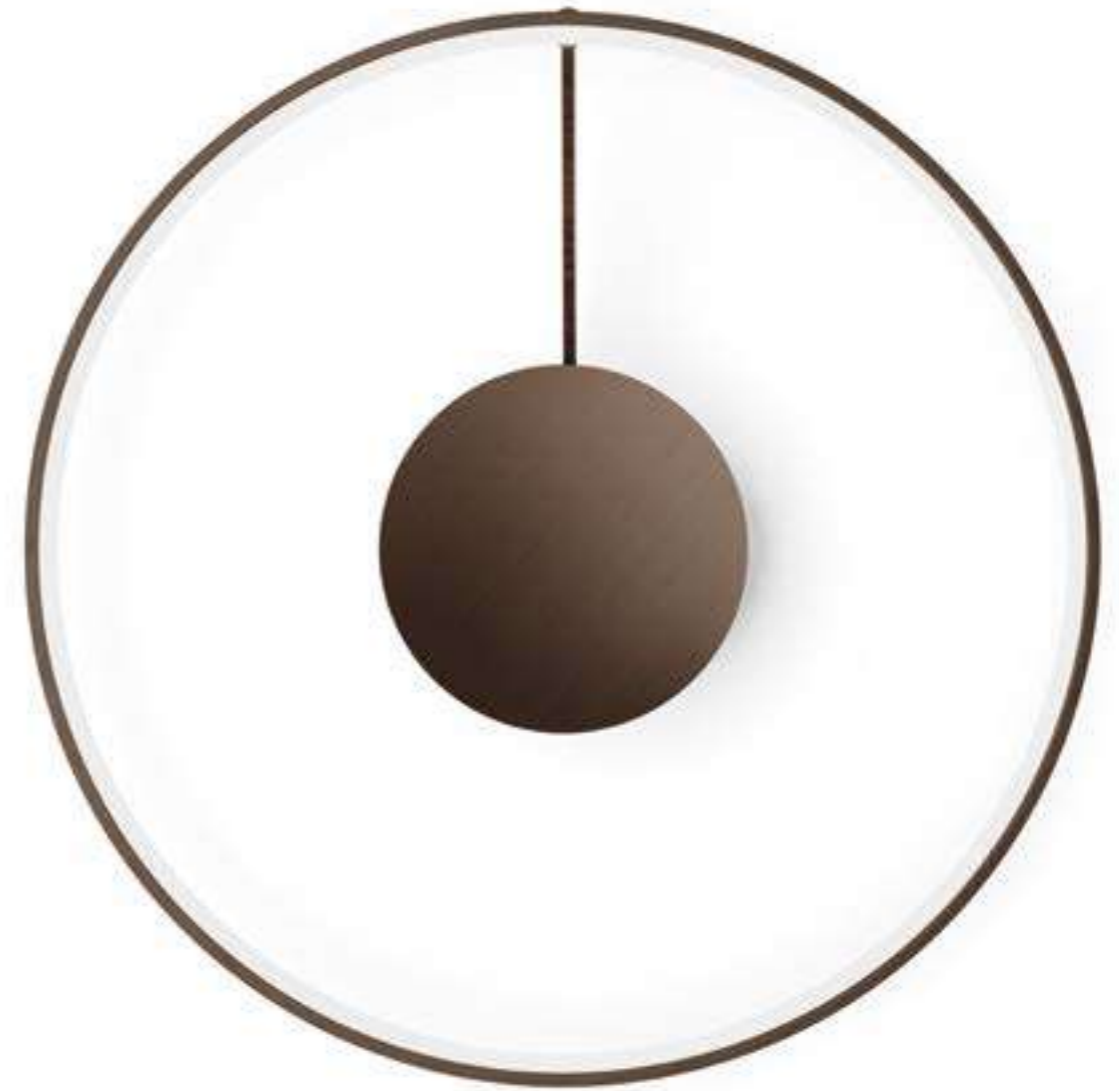

ANELLO

CEILING





ANELLO CEILING



ANELLO CEILING



ANELLO

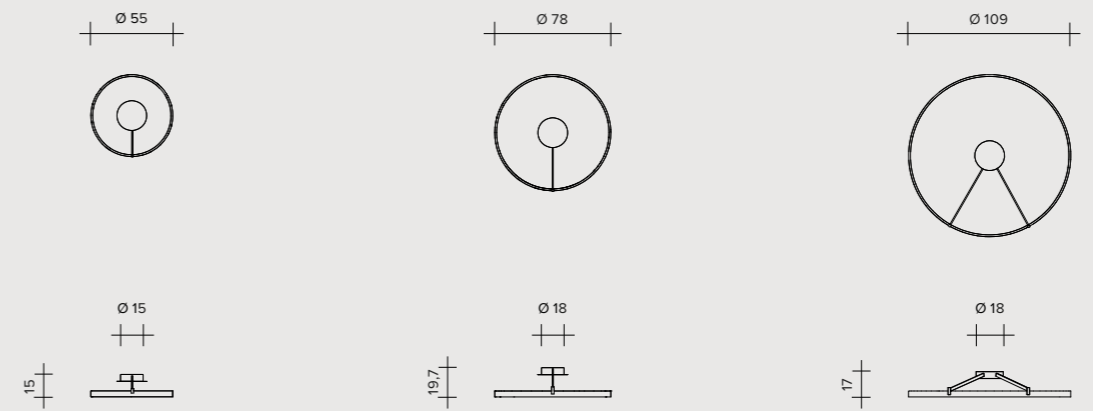

33W - 24V LED
2700°K / 2668 lumen
3000°K / 2965 lumen

Versions:

On-Off

Push
Dali
0-10v
1-10v

47W - 24V LED
2700°K / 2761 lumen
3000°K / 3068 lumen

Versions:

On-Off

Push
Dali
0-10v
1-10v

Triac

65W - 24V LED
2700°K / 3832 lumen
3000°K / 4258 lumen

Versions:

On-Off

Push
Dali
0-10v
1-10v

Triac

ANELLO Ceiling lamp

Lampada da soffitto
Deckenleuchte
Lámpara de techo
Потолочный светильник

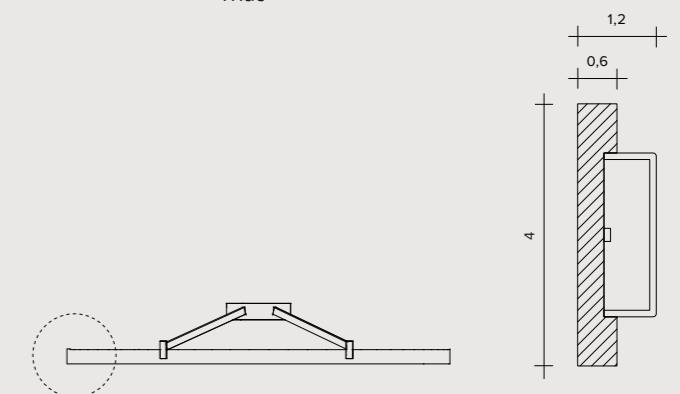

FINISHES / FINITURE / AUSFÜHRUNGEN / ACABADOS / ОТДЕЛКИ

- Painted black / Nero verniciato / Schwarz lackiert
Negro pintado / Окрашено в Черный
- Brushed bronze / Bronzo spazzolato / Bronze gebürstet
Bronce cepillado / Брашированная бронза
- Brushed gold / Oro spazzolato / Gold gebürstet
Oro cepillado / Брашированное золото
- Brushed copper / Rame spazzolato / Kupfer gebürstet
Cobre cepillado / Крацованная медь



ANELLO

SUSPENSION

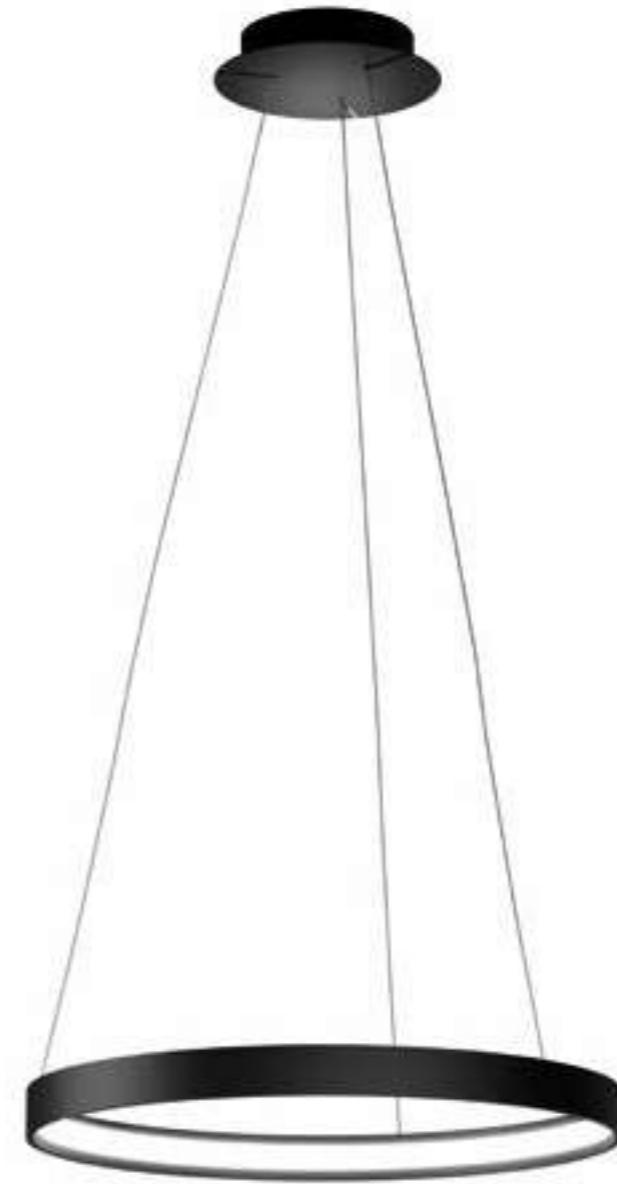

ANELLO SUSPENSION





ANELLO SUSPENSION



ANELLO SUSPENSION

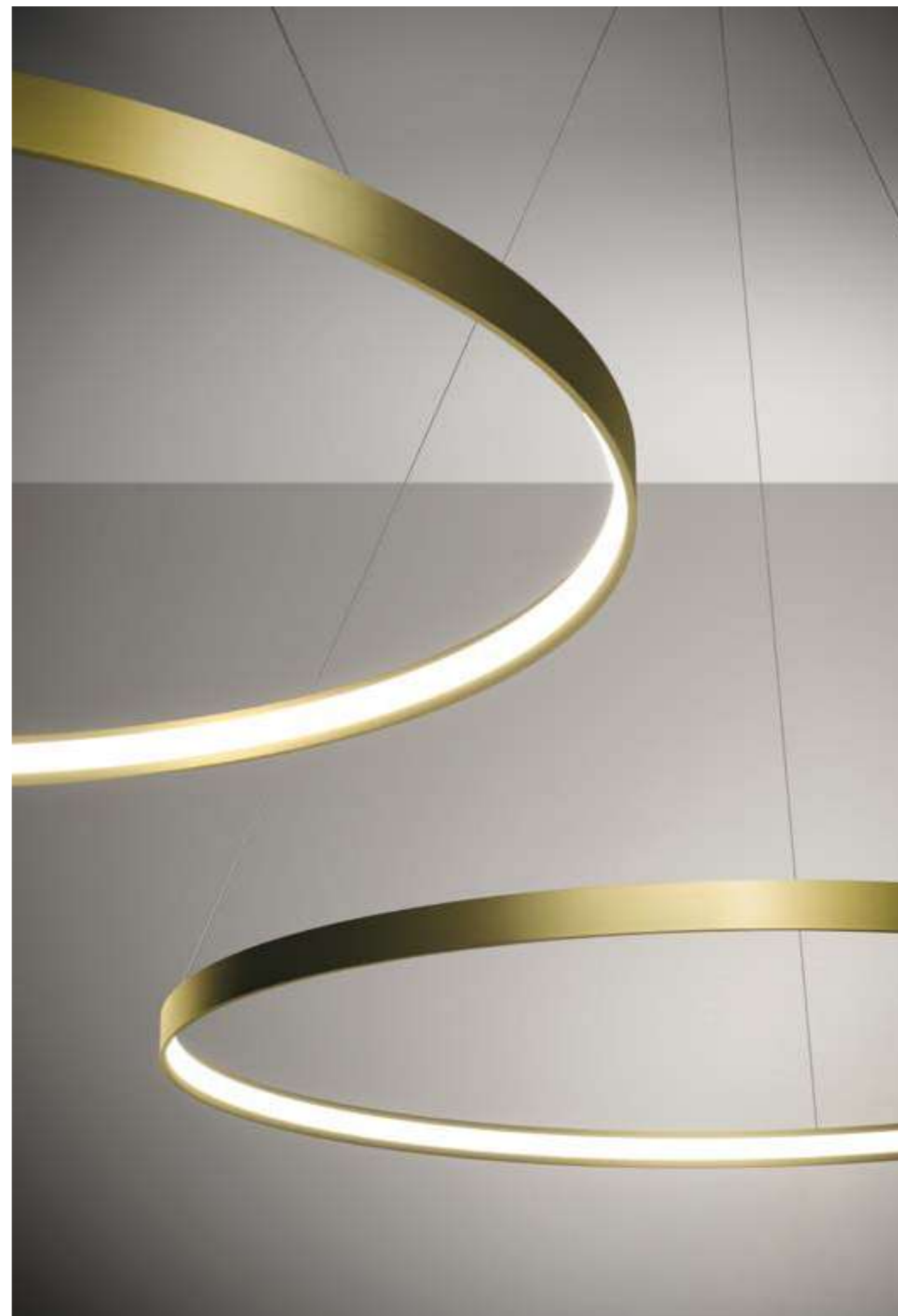

ANELLO SUSPENSION



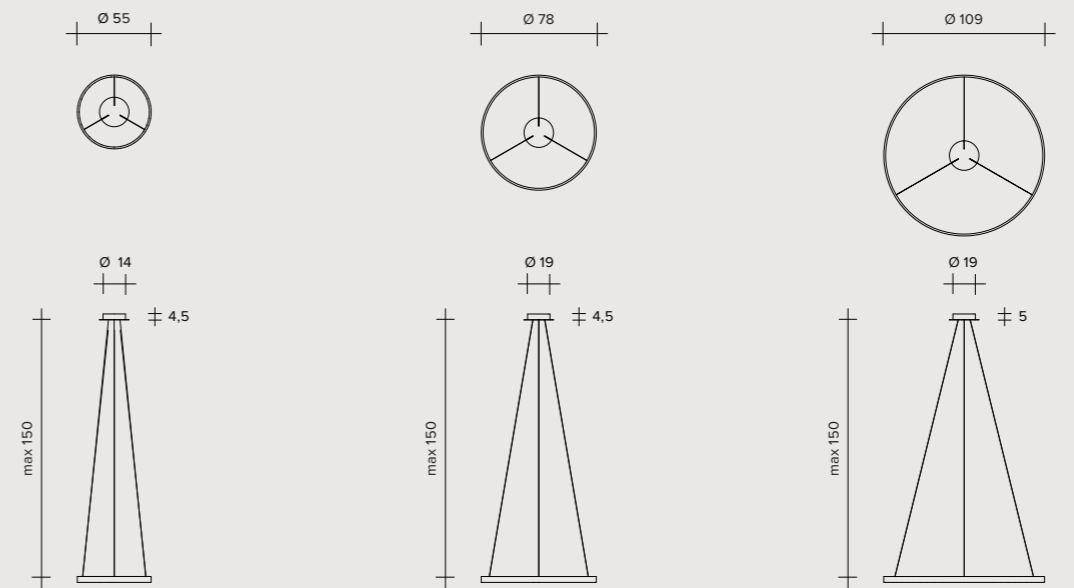

33W - 24V LED
2700°K / 2668 lumen
3000°K / 2965 lumen

Versions:

On-Off

Push
Dali
0-10v
1-10v

47W - 24V LED
2700°K / 2761 lumen
3000°K / 3068 lumen

Versions:

On-Off

Push
Dali
0-10v
1-10v

Triac

65W - 24V LED
2700°K / 3832 lumen
3000°K / 4258 lumen

Versions:

On-Off

Push
Dali
0-10v
1-10v

Triac

ANELLO Suspension lamp

Lampada a sospensione
Pendelleuchte
Lámpara colgante
Подвесной светильник

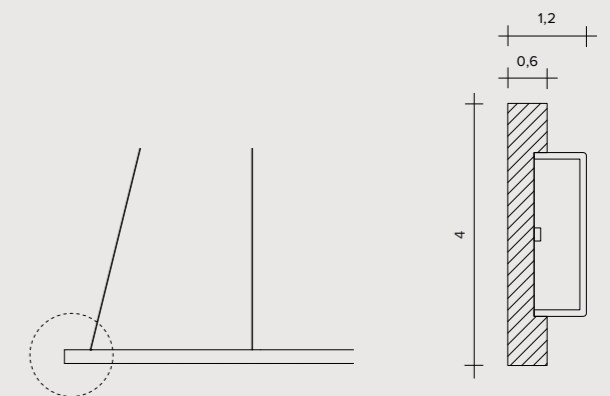

FINISHES / FINITURE / AUSFÜHRUNGEN / ACABADOS / ОТДЕЛКИ

- Painted black / Nero verniciato / Schwarz lackiert
Negro pintado / Окрашено в Черный
- Brushed bronze / Bronzo spazzolato / Bronze gebürstet
Bronce cepillado / Брашированная бронза
- Brushed gold / Oro spazzolato / Gold gebürstet
Oro cepillado / Брашированное золото
- Brushed copper / Rame spazzolato / Kupfer gebürstet
Cobre cepillado / Крацованная медь

ANELLO DOUBLE SUSPENSION

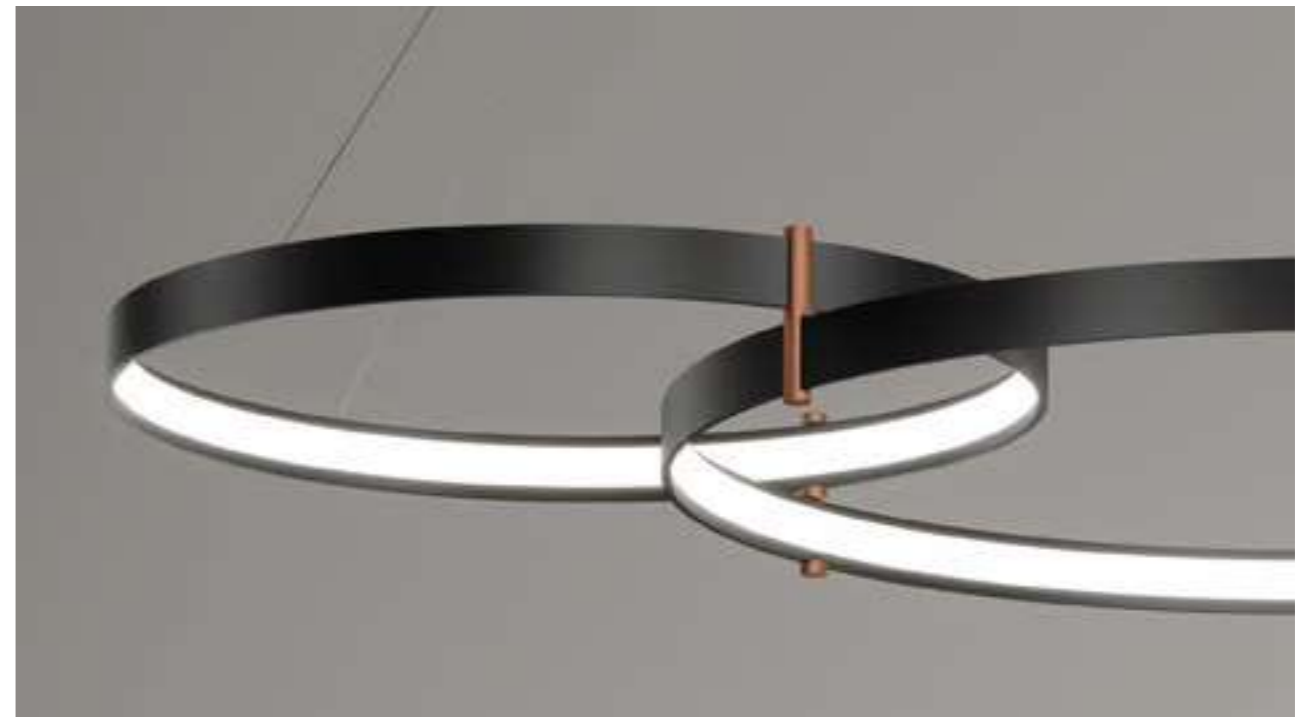

ANELLO DOUBLE
SUSPENSION



ANELLO

DOUBLE
SUSPENSION



ANELLO DOUBLE
SUSPENSION



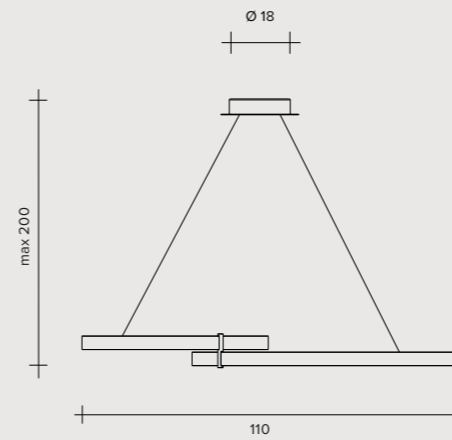

80 W - 24V LED
2700°k / 5429 lumen
3000°K / 6033 lumen

Versions:

On-Off

Push
Dali
0-10v
1-10v

Triac

ANELLO Double suspension lamp

Lampada a sospensione
Pendelleuchte
Lámpara colgante
Подвесной светильник



FINISHES / FINITURE / AUSFÜHRUNGEN / ACABADOS / ОТДЕЛКИ

- Painted black / Nero verniciato / Schwarz lackiert
Negro pintado / Окрашено в Черный
- Brushed bronze / Bronzo spazzolato / Bronze gebürstet
Bronce cepillado / Брашированная бронза
- Brushed gold / Oro spazzolato / Gold gebürstet
Oro cepillado / Брашированное золото
- Brushed copper / Rame spazzolato / Kupfer gebürstet
Cobre cepillado / Крацованная медь



Joint kit for double suspension Anello lamp (Not included, available as optional)

Kit giunti per anello double suspension (Non incluso, da ordinare a parte)
Verbindungssatz für Anello doppelte Aufhängung (Nicht inbegriffen, separat zu bestellen)
Kit juntas para Anello Double Suspension (No incluida, disponible como opcional)
Комплект креплений для anello double suspension (Не входит в комплект поставки, заказывается отдельно)

FINISHES / FINITURE / AUSFÜHRUNGEN / ACABADOS / ОТДЕЛКИ

- Painted black / Nero verniciato / Schwarz lackiert
Negro pintado / Окрашено в Черный
- Brushed bronze / Bronzo spazzolato / Bronze gebürstet
Bronce cepillado / Брашированная бронза
- Brushed gold / Oro spazzolato / Gold gebürstet
Oro cepillado / Брашированное золото
- Brushed copper / Rame spazzolato / Kupfer gebürstet
Cobre cepillado / Брашированная медь
- Aluminium / Alluminio / Aluminium
Aluminio / Алюминий

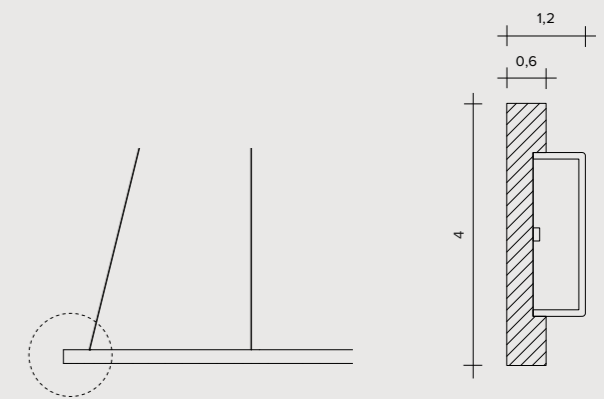

AKI

Extravergine

AKI

Discretion is the privilege of this wall lamp that expresses in the harmony of its shape the values associated with the concept of minimalist aesthetics. Moderation and restraint are the expressive measure of its recyclable die-cast aluminium body. It includes an integrated heat sink with LED to ensure performance, light quality and durability. The lighting is diffuse and washes the wall evenly.

AKI

Discrezione è il privilegio di questa lampada da parete che sa esprimere nell'armonia delle sue forme i valori legati al concetto di estetica minimalista. Moderazione e riserbo sono la misura espressiva del corpo in alluminio pressofuso riciclabile. Include un dissipatore integrato con un LED per garantire prestazioni, qualità della luce e durata. L'illuminazione è diffusa, e lava uniformemente la parete.

AKI

Diskretion ist das Privileg dieser Wandleuchte, die in der Lage ist, in der Harmonie ihrer Formen die Werte auszudrücken, die mit dem Konzept der minimalistischen Ästhetik verbunden sind. Mäßigung und Zurückhaltung sind das ausdrucksstarke Maß des recycelbaren Aluminiumdruckgusskörpers. Enthält einen integrierten Kühlkörper mit einer LED, um Leistung, Lichtqualität und Haltbarkeit zu gewährleisten. Die Beleuchtung ist diffus und umspült die Wand gleichmäßig.

AKI

La discreción es el privilegio de esta lámpara de pared que sabe expresar en la armonía de sus formas los valores asociados al concepto de estética minimalista. Moderación y sobriedad son la medida expresiva del cuerpo de aluminio reciclable fundido a presión. Incluye un disipador integrado con un LED para garantizar el rendimiento, la calidad de la luz y la durabilidad. La iluminación es difusa y baña uniformemente la pared.

AKI

Сдержанность - самая благородная черта этого настенного светильника, чья гармоничность форм олицетворяет ценности, связанные с концепцией эстетики минимализма. Сдержанность и строгость - именно в них таится сила экспрессии, которую несет в себе корпус из переработанного алюминия, отлитого под давлением. Комплектуется встроенным светодиодным рассеивателем, обеспечивающим высокую эффективность, качество освещения и долговечность. Рассеянный свет равномерно «омывает» стену.







AKI WALL



AKI WALL



AKI WALL

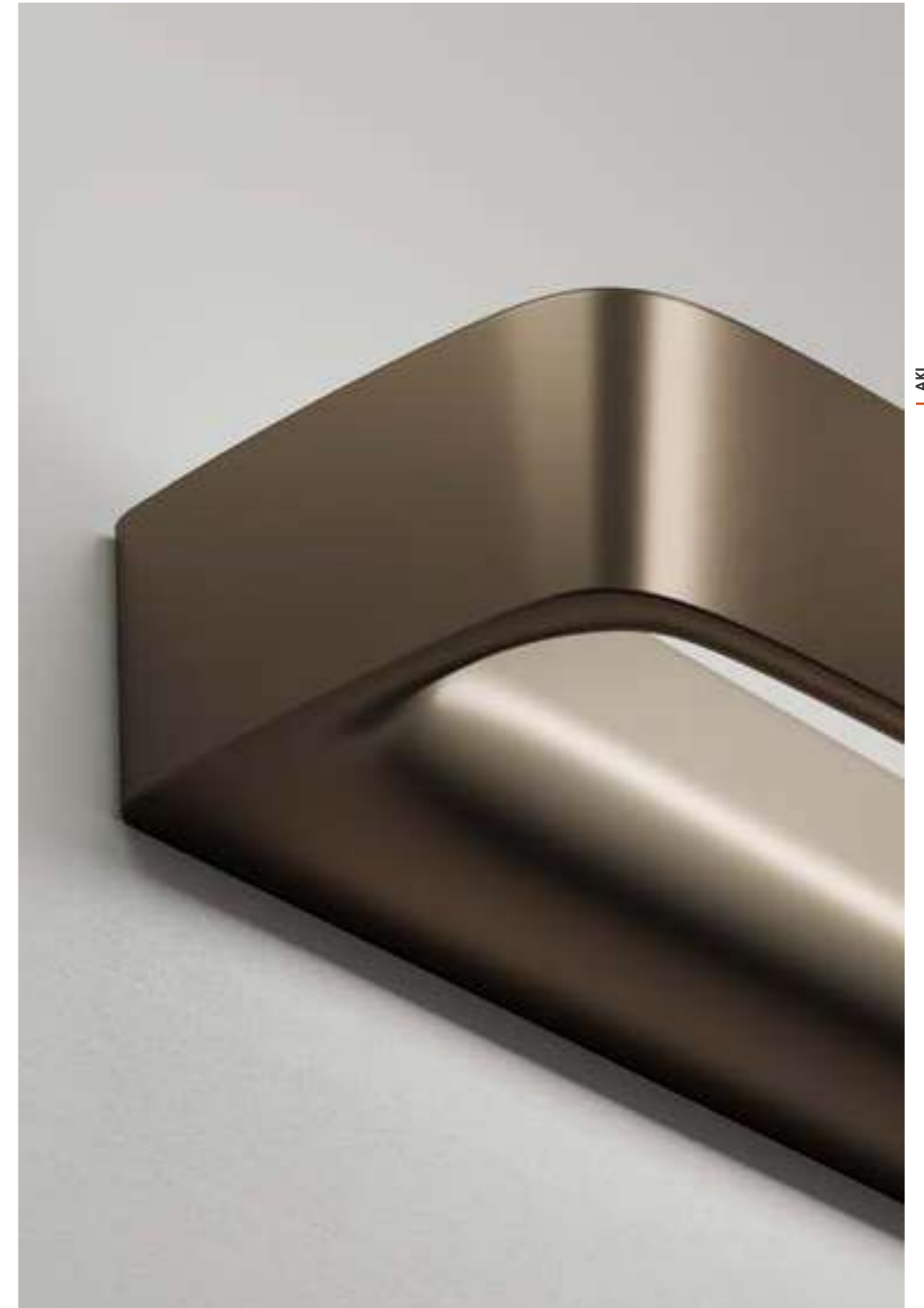



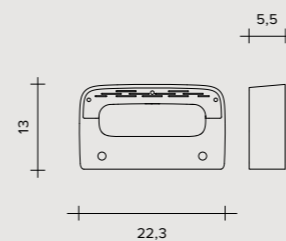

11W LED
 2700°K / 1567 lumen
 3000°K / 1650 lumen
 4000°K / 1733 lumen
 CRI 90

Versions:

On-Off

Push

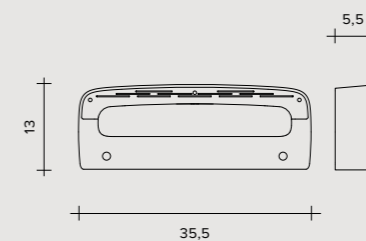

22W LED
 2700°K / 3054 lumen
 3000°K / 3215 lumen
 4000°K / 3375 lumen
 CRI 90

Versions:

On-Off

Push

AKI Wall lamp

Lampada da parete

Wandleuchte

Lámpara de pared

Настенный светильник



FINISHES / FINITURE / AUSFÜHRUNGEN / ACABADOS / ОТДЕЛКИ

- White / Bianco / Weiß / Blanco / Белый
- Gold / Oro / Gold / Oro / Золото
- Copper / Rame / Kupfer / Cobre / Медь
- Bronze / Bronzo / Bronze / Bronce / Бронза
- Anthracite grey / Antracite / Anthrazit / Antracita / Антрацит

OLO

Marco Spatti

OLO

Light captured by aesthetics,
clean geometries and defined lines.
A wall lamp that knows how to
characterises an environment,
both on and off.
It is unobtrusive and fits
well in any interior.
Section changes, full and voids,
define the design lightly.
Even wall lighting.
One-of-a-kind die-cast
aluminium body.

WINNER



OLO

*Luce catturata dall'estetica,
geometrie pulite e linee definite,
una lampada da parete che sa
caratterizzare gli ambienti
sia accesa che spenta.
Non è intrusiva, si adatta
a qualsiasi interno.
I cambi di sezione, i pieni
e i vuoti, definiscono il design
con leggerezza.
L'illuminazione della parete
è uniforme. Il corpo realizzato
in pressofusione d'alluminio
è un pezzo unico.*

OLO

*Licht, eingefangen in Ästhetik,
klaren Geometrien und definierten
Linien, eine Wandleuchte,
die weiß, wie man Räume
sowohl an- als auch
ausgeschaltet charakterisiert.
Unauffällig passt sich die
Leuchte jedem Innenraum an.
Der Wechsel von Sektionen,
Körpern und Hohlräumen verleiht
dem Design Leichtigkeit.
Die Wandbeleuchtung ist einheitlich.
Das Gehäuse aus Aluminiumdruckguss
ist ein einziges Teil.*

OLO

*Luz captada por la estética,
geometrías limpias y líneas
definidas, una lámpara de pared
que sabe caracterizar los ambientes
tanto encendida como apagada.
Es discreta y encaja en cualquier
ambiente interior.
Los cambios de sección y
los volúmenes llenos y vacíos
definen el diseño con ligereza.
La iluminación de la pared
es uniforme. El cuerpo de
aluminio fundido a presión
forma una pieza única.*

OLO

*Свет, плененный эстетикой, чистыми
геометрическими формами и четкими
линиями: настенный светильник,
способный создавать
особую атмосферу в помещениях,
даже будучи выключенным.
Он не создает визуального шума и
вписывается в любой интерьер.
Меняющиеся сечения, игра полных
и пустых объемов формируют дизайн,
пронизанный ощущением легкости.
Стена освещается равномерным
образом. Монолитный корпус выполнен
из отлитого под давлением алюминия.*









OLO WALL





OLO WALL





OLO WALL





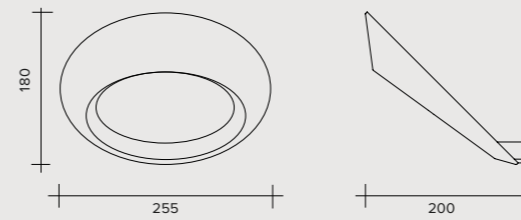

OLO Wall lamp

Lampada da parete
Wandleuchte
Lámpara de pared
Настенный светильник



FINISHES / FINITURE / AUSFÜHRUNGEN / ACABADOS / ОТДЕЛКИ

- White / Bianco / Weiß / Blanco / Белый
- Anthracite grey / Antracite / Anthrazit / Антрацит
- Brushed copper / Rame spazzolato / Kupfer gebürstet / Cobre cepillado / Крацованная медь
- Brushed bronze / Bronzo spazzolato / Bronze gebürstet / Bronce cepillado / Брашированная бронза
- Brushed gold / Oro spazzolato / Gold gebürstet / Oro cepillado / Брашированное золото

LIGHT SOURCE / SORGENTE / LICHTQUELLE / FUENTE LUMINOSA / ИСТОЧНИК СВЕТА

33W - 230V LED 2700°K / 3085 lumen
 3000°K / 3300 lumen
 4000°K / 3515 lumen

RECOMMENDED DIMMER SWITCHES / DIMMER CONSIGLIATI / EMPFOHLENE DIMMER / REGULADORES DE INTENSIDAD RECOMENDADOS / РЕКОМЕНДУЕМЫЕ ДИММЕРЫ

code 1776.CASAMBI

Bluetooth dimmer, controls up to 4 lights, remote installation.
 Dimmer Bluetooth, gestisce fino a 4 lampade, installazione in remoto.
 Bluetooth-Dimmer, verwaltet bis zu 4 Lampen, Ferninstallation.
 Regulador de intensidad luminosa Bluetooth, para el control de hasta 4 lámparas, instalación a distancia.
 Диммер bluetooth, возможность подключения до 4 ламп, выносная установка.

code 1776.DIM

Phase cut dimmer, 230V AC, in/out, controls up to 6 lights, adjustable minimum setting, remote installation.
 Dimmer a taglio di fase 230vac, in/out, gestisce fino a 6 lampade, minimo programmabile, installazione in remoto.
 Phasenanschnittdimmer 230Vac, in/out, verwaltet bis zu 6 Lampen, Minimum programmierbar, Ferninstallation.
 Regulador de intensidad luminosa con corte de fase 230 Vca, in/out, para el control de hasta 6 lámparas, mínimo programable, instalación a distancia.
 Диммер с отсечкой фазы 230 В перем. тока, вход/выход, возможность подключения до 6 ламп, программируемый минимальный уровень диммирования, выносная установка.

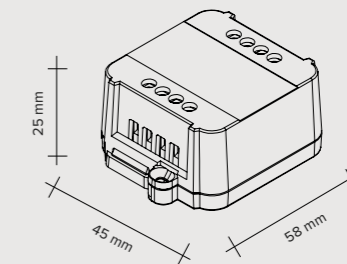
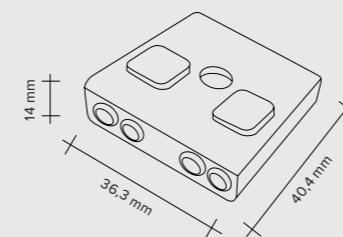

HOLE COVER / COPRIFORO / LOCHABDECKUNG / TAPA PARA ORIFICIOS / ЗАГЛУШКА

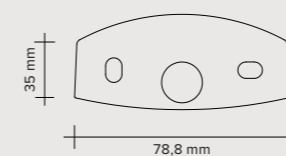

Wall hole cover plate in metal, painted white.
 Supplied as standard, used for installations on walls with large sized holes.
 Piastrina copriforo parete in metallo, verniciata bianca. Fornita di serie, utile per installazioni su pareti con fori di grandi dimensioni.
 Lochabdeckung für Wände, aus Metall, weiß lackiert. Wird serienmäßig mitgeliefert und ist nützlich bei einer Installation an der Wand, wenn das Loch einen großen Durchmesser hat.
 Tapa para orificios de metal para pared, pintada en blanco.
 Suministrada de serie, útil para instalaciones en paredes con orificios grandes.
 Металлическая накладка для закрытия отверстий в стене, окрашенная в белый цвет.
 Накладка входит в комплект поставки, подходит для установки на стены с отверстиями большого размера.

LINEA

blank design studio + Gerardo Mari

REGISTERED TRADEMARK_MODELLO REGISTRATO
GESCHÜTZTES MODELL_MODELO REGISTRADO
ЗАРЕГИСТРИРОВАННАЯ МОДЕЛЬ

LINEA

Linearity is the philosophy of this product.

A system of flexible LED lighting elements with a harmonic steel core that reinvents the way light is experienced in an environment. Linea can be stretched between two opposing planes, mounted on the wall (wall/wall or wall/ceiling), installed directly with surface mounting or suspended to the ceiling. It can also be composed into free geometric shapes. The silicone cover evenly diffuses light, generated by two opposing LED strips with a combined output of up to 1900 lumens/metre.

WINNER



LINEA

La linearità è la filosofia del prodotto. Un sistema di elementi illuminanti flessibili a led con un'anima in acciaio armonico che reinventa il modo di vivere la luce negli ambienti. Linea può essere tesa tra due piani opposti, montabile sulla parete (parete/parete o parete/soffitto), installata direttamente con montaggio superficiale o può essere sospesa al soffitto e composta anche in forme geometriche libere. La copertura siliconica diffonde in modo uniforme la luce, generata da due strip led contrapposte con resa combinata fino a 1900 lumen/metro.

LINEA

Linearität ist die Philosophie des Produkts. Ein System flexibler LED-Beleuchtungselemente mit einem harmonischen Stahlkern, das die Art und Weise Licht in Umgebungen zu erleben, neu erfindet. Linea kann zwischen zwei gegenüberliegenden Ebenen gespannt, an der Wand montiert (Wand/Wand oder Wand/Decke), direkt per Oberflächenmontage installiert oder an der Decke aufgehängt und auch in freien geometrischen Formen zusammengestellt werden. Die Silikonabdeckung sorgt für eine gleichmäßige Streuung des Lichts, das von zwei gegenüberliegenden LED-Streifen mit einer Gesamtleistung von bis zu 1900 Lumen/Meter erzeugt wird.

LINEA

La linealidad es la filosofía del producto. Un sistema de elementos de iluminación LED flexibles con un núcleo de acero armónico que reinventa la manera de experimentar la iluminación en los ambientes. Linea puede tensarse entre dos planos opuestos, montarse en la pared (pared/pared o pared/techo), instalarse directamente con montaje en superficie o puede suspenderse del techo e incluso crear composiciones geométricas libres. La cubierta de silicona difunde uniformemente la luz, generada por dos tiras de LED opuestas con una potencia combinada de hasta 1900 lúmenes/metro.

LINEA

Философией этого изделия является линейность. Система гибких светодиодных световых элементов с сердечником из пружинной стали, которая представляет собой переосмысление концепции освещения помещений. Светильники Linea можно размещать между двумя противоположными плоскостями, закрепив на стене (стена/стена или стена/потолок); можно выполнить поверхностный монтаж, повесить светильник к потолку либо создать композицию из геометрических фигур. Силиконовый кожух равномерно рассеивает свет, излучаемый двумя противоположащими светодиодными лентами с суммарным световым потоком до 1900 люмен/метр.

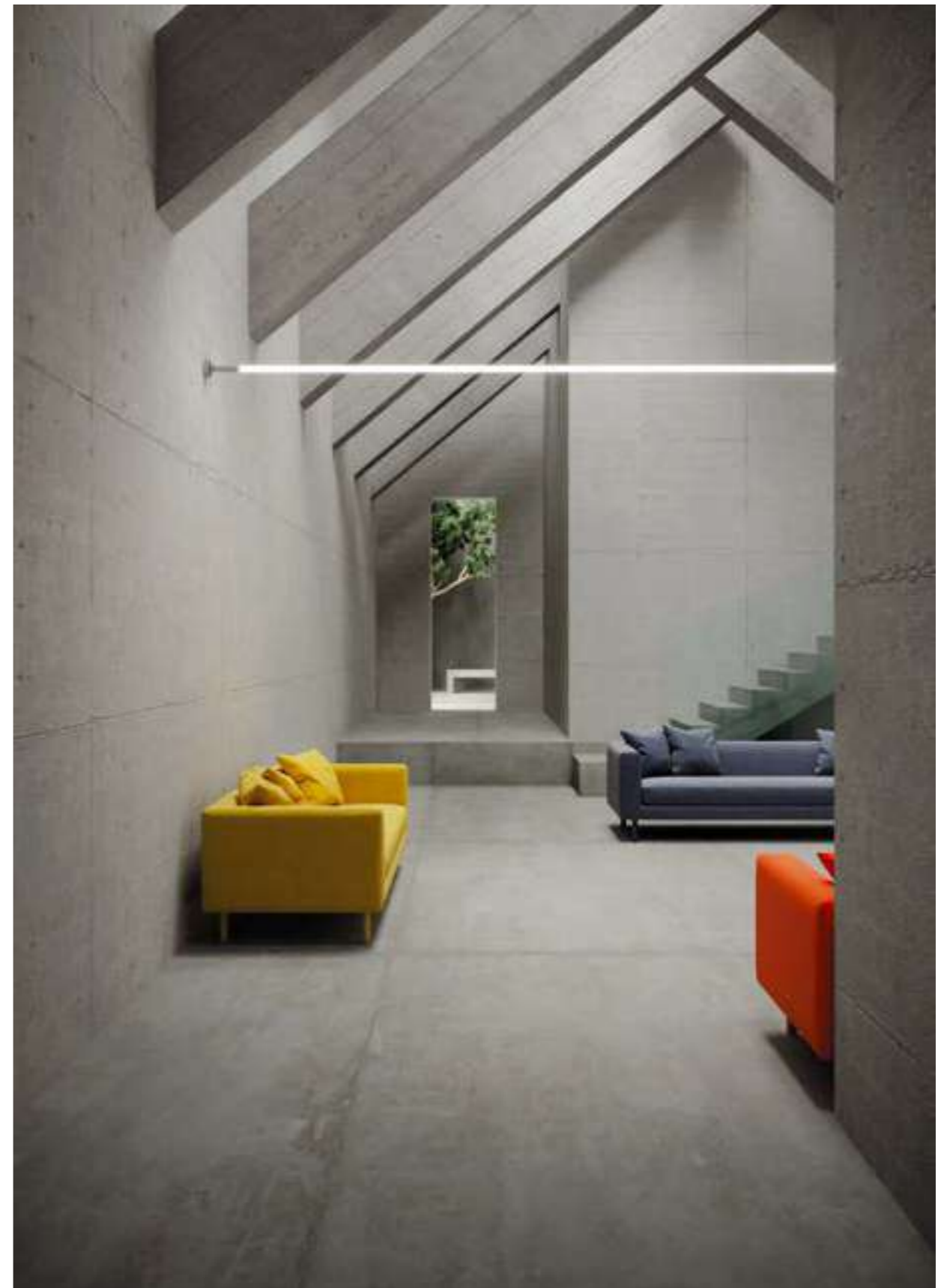



LINEA WALL-WALL





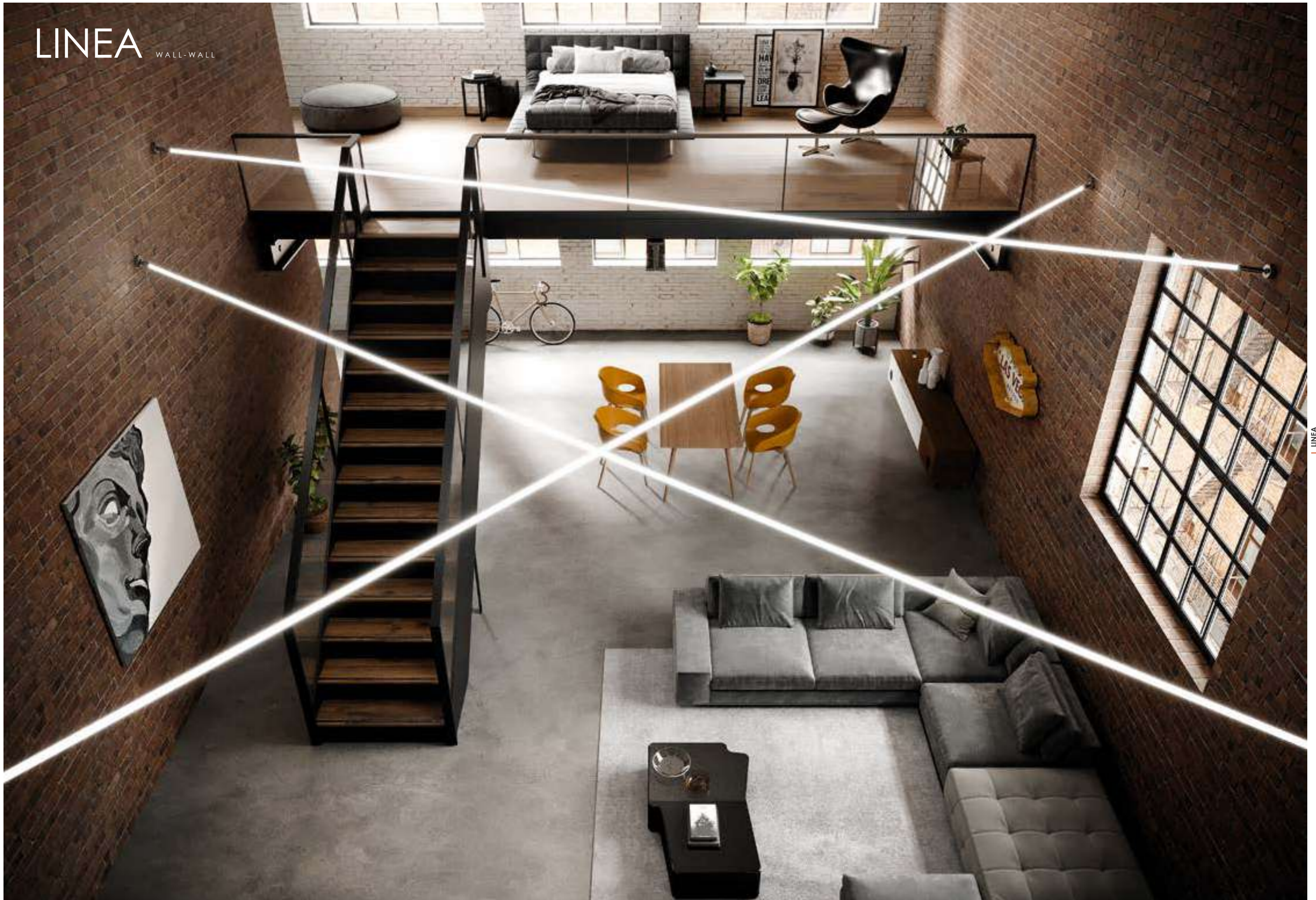

Wall-wall assembly

Installazione parete/parete / Wand/Wand-Installation / Instalación pared/pared / Установка от стены до стены

Remote driver options

Opzioni con driver remoto
Optionen mit entfernt liegendem Driver
Opciones con controlador remoto
Версия с выносным драйвером

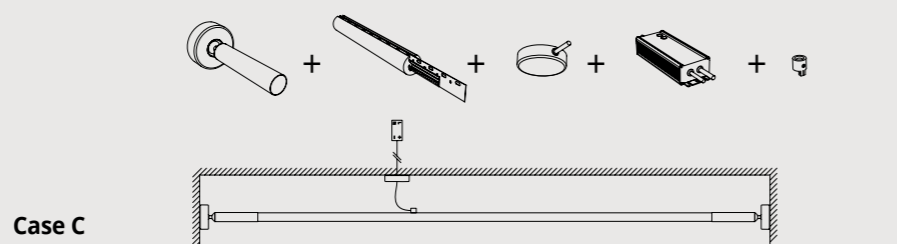
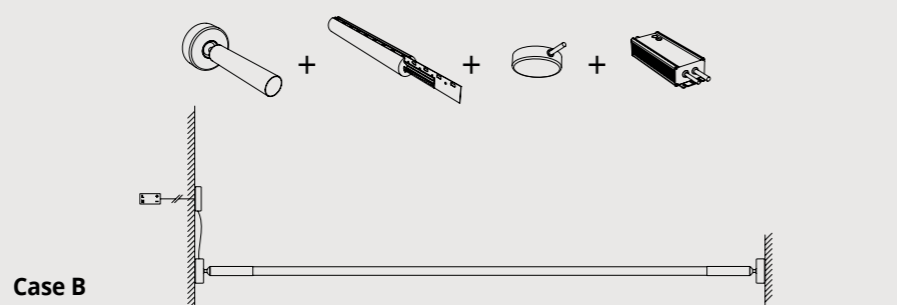
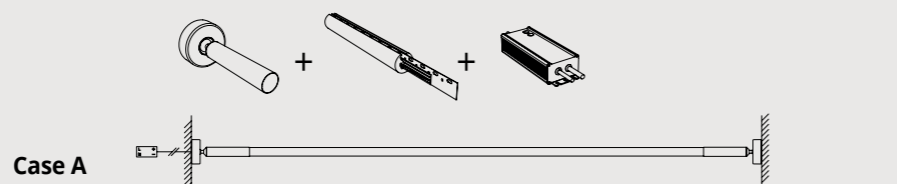

On-board driver options

Opzioni con driver a bordo
Optionen mit an der Einheit befindlichem Driver
Opciones con controlador incorporado
Версия со встроенным драйвером

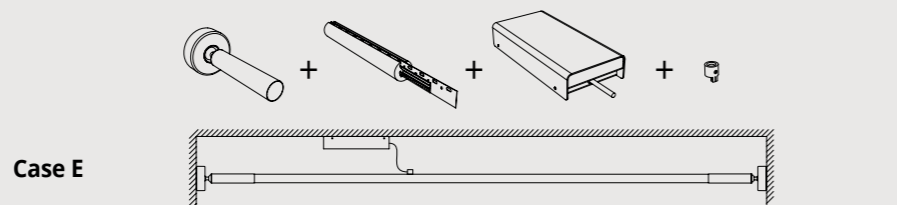
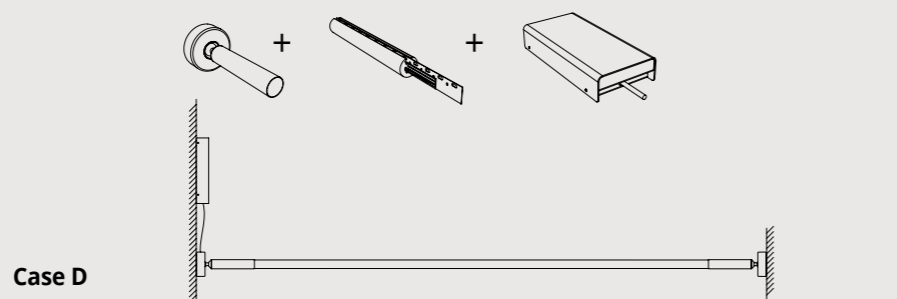

WALL-WALL / FLOOR-CEILING DIMENSIONS

Dimensione parete-parete / terra-soffitto
Abmessungen Wand-Wand / Boden-Decke
Medida pared-pared / suelo-techo
Версия от стены до стены / от пола до потолка

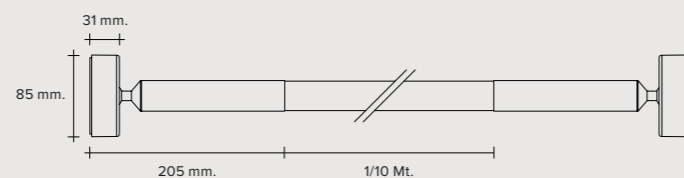

LINEA

System

Linear LED lighting system
Sistema di illuminazione lineare a Led
Lineares LED-Beleuchtungssystem
Sistema de iluminación LED lineal
Линейная светодиодная система освещения

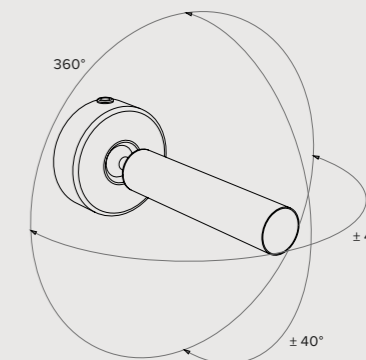

FINISHES / FINITURE / AUSFÜHRUNGEN / ACABADOS / ОТДЕЛКИ

FRAME - CEILING CANOPIES - DRIVER BOX

Montatura - Rosoni - Driver Box / Rahmen - Baldachine - Driver Box / Estructura - Rosetones - Caja de controladores
Каркас - Основания - Коробки для драйверов

- Brushed aluminium / Alluminio spazzolato / Gebürstetes Aluminium / Aluminio cepillado / Крацованный алюминий
- Black / Nero / Schwarz / Negro / Черный
- Sand / Sabbia / Sand / Arena / Песочный

DIFFUSER

Diffusore / Diffusor / Difusor / Рассеиватель

- White opaline silicone / Silicone bianco opalino / Weißes, opales Silikon / Silicona blanca opalina / Силикон опаловый белый

LIGHT SOURCE / SORGENTE / LICHTQUELLE / FUENTE LUMINOSA / ИСТОЧНИК СВЕТА

1 m.	LED 20W	48V	2700°K / 1700 Lumen	CRI 90	6 m.	LED 120W	48V	2700°K / 10200 Lumen	CRI 90
			3000°K / 1900 Lumen	CRI 90				3000°K / 11400 Lumen	CRI 90
2 m.	LED 40W	48V	2700°K / 3400 Lumen	CRI 90	7 m.	LED 140W	48V	2700°K / 11900 Lumen	CRI 90
			3000°K / 3800 Lumen	CRI 90				3000°K / 13300 Lumen	CRI 90
3 m.	LED 60W	48V	2700°K / 5100 Lumen	CRI 90	8 m.	LED 160W	48V	2700°K / 13600 Lumen	CRI 90
			3000°K / 5700 Lumen	CRI 90				3000°K / 15200 Lumen	CRI 90
4 m.	LED 80W	48V	2700°K / 6800 Lumen	CRI 90	9 m.	LED 180W	48V	2700°K / 15300 Lumen	CRI 90
			3000°K / 7600 Lumen	CRI 90				3000°K / 17100 Lumen	CRI 90
5 m.	LED 100W	48V	2700°K / 8500 Lumen	CRI 90	10 m.	LED 200W	48V	2700°K / 17000 Lumen	CRI 90
			3000°K / 9500 Lumen	CRI 90				3000°K / 19000 Lumen	CRI 90

DRIVER BOX L

xxxx.B3
xxxx.B5
xxxx.B6

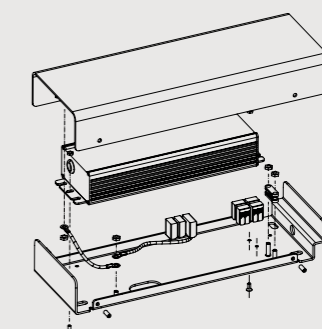
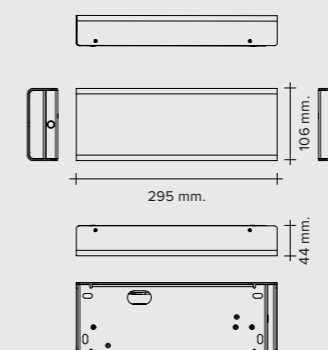

DRIVER BOX S

xxxx.B1
xxxx.B2
xxxx.B4

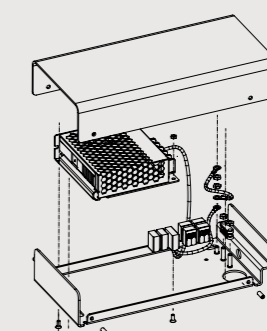
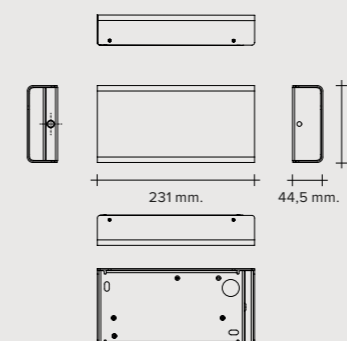

CANOPY

xxxx.M4



* Power cable: 1,2 m.

Cavo di alimentazione: 1,2 m. / Stromversorgungskabel: 1,2 m. / Cable de alimentación: 1,2 m. / Шнур питания: 1,2 м.

Go to the page(s) specified for codes and prices / Vedi codici e prezzi da pag a pag. / Artikelnummern und Preise siehe Seite bis Seite
Véanse los códigos y precios desde pág. hasta pág. / См. постраничную информацию о кодах и ценах

334 - 335 - 336 - 337



LINEA

SURFACE MOUNTING





LINEA SURFACE MOUNTING



LINEA

LINEA

SURFACE MOUNTING



Surface mounting

Installazione superficiale / Aufputzmontage / Instalación en superficie / Поверхностная установка

Remote driver options

Opzioni con driver remoto
Optionen mit entfernt liegendem Driver
Opciones con controlador remoto
Версия с выносным драйвером

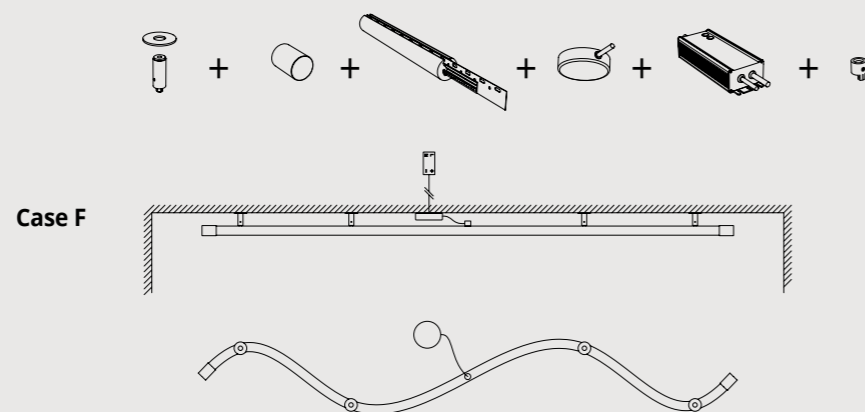

On-board driver options

Opzioni con driver a bordo
Optionen mit an der Einheit befindlichem Driver
Opciones con controlador incorporado
Версия со встроенным драйвером

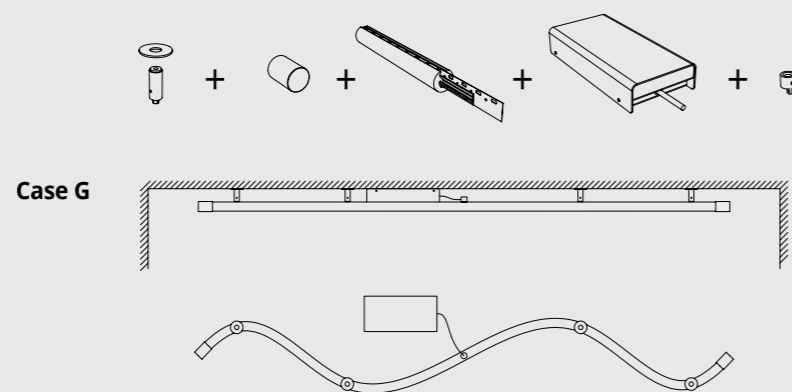

WALL / CEILING DIMENSIONS

Dimensione parete / soffitto
Abmessungen Wand/Decke
Medidas pared / techo
Версия стена / потолок

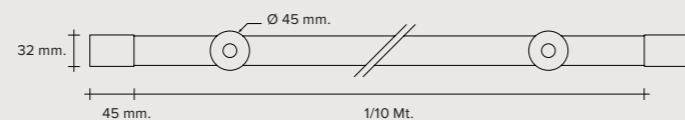

* Power cable: 1,5 m.

Cavo di alimentazione: 1,5 m. / Stromversorgungskabel: 1,5 m. / Cable de alimentación: 1,5 m. / Шнур питания: 1,5 м.

FOR THE FOLLOWING TYPES OF INSTALLATIONS, PLEASE SHARE WITH US SIZE A WHEN PLACING THE ORDER

Nei seguenti casi di installazione comunicare la misura A al momento dell'ordine / In den folgenden Installationssituationen bitte bei der Bestellung das Maß A mitteilen / En los siguientes casos de instalación al hacer el pedido es necesario indicar la medida A / В следующих случаях при размещении заказа следует сообщить размер A

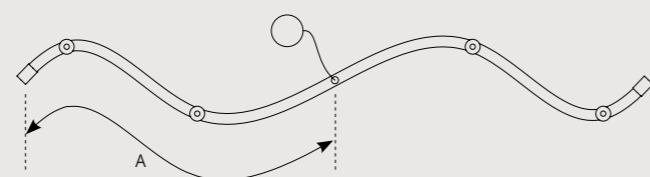

LINEA

System

Linear LED lighting system
Sistema di illuminazione lineare a Led
Lineares LED-Beleuchtungssystem
Sistema de iluminación LED lineal
Линейная светодиодная система освещения



FINISHES / FINITURE / AUSFÜHRUNGEN / ACABADOS / ОТДЕЛКИ

FRAME - CEILING CANOPIES - DRIVER BOX

Montatura - Rosoni - Driver Box / Rahmen - Baldachine - Driver Box / Estructura - Rosetones - Caja de controladores
Каркас - Основания - Коробки для драйверов

- Brushed aluminium / Alluminio spazzolato / Gebürstetes Aluminium / Aluminio cepillado / Крацованный алюминий
- Black / Nero / Schwarz / Negro / Черный
- Sand / Sabbia / Sand / Arena / Песочный

DIFFUSER

Diffusore / Diffusor / Difusor / Рассеиватель

- White opaline silicone / Silicone bianco opalino / Weißes, opales Silikon / Silicona blanca opalin / Силикон опаловый белый

LIGHT SOURCE / SORGENTE / LICHTQUELLE / FUENTE LUMINOSA / ИСТОЧНИК СВЕТА

1 m.	LED 20W	48V	2700°K / 1700 Lumen	CRI 90	6 m.	LED 120W	48V	2700°K / 10200 Lumen	CRI 90
			3000°K / 1900 Lumen	CRI 90				3000°K / 11400 Lumen	CRI 90
2 m.	LED 40W	48V	2700°K / 3400 Lumen	CRI 90	7 m.	LED 140W	48V	2700°K / 11900 Lumen	CRI 90
			3000°K / 3800 Lumen	CRI 90				3000°K / 13300 Lumen	CRI 90
3 m.	LED 60W	48V	2700°K / 5100 Lumen	CRI 90	8 m.	LED 160W	48V	2700°K / 13600 Lumen	CRI 90
			3000°K / 5700 Lumen	CRI 90				3000°K / 15200 Lumen	CRI 90
4 m.	LED 80W	48V	2700°K / 6800 Lumen	CRI 90	9 m.	LED 180W	48V	2700°K / 15300 Lumen	CRI 90
			3000°K / 7600 Lumen	CRI 90				3000°K / 17100 Lumen	CRI 90
5 m.	LED 100W	48V	2700°K / 8500 Lumen	CRI 90	10 m.	LED 200W	48V	2700°K / 17000 Lumen	CRI 90
			3000°K / 9500 Lumen	CRI 90				3000°K / 19000 Lumen	CRI 90

DRIVER BOX L

xxxx.B3
xxxx.B5
xxxx.B6

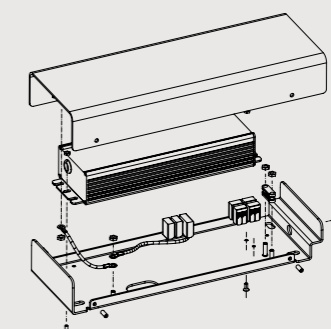
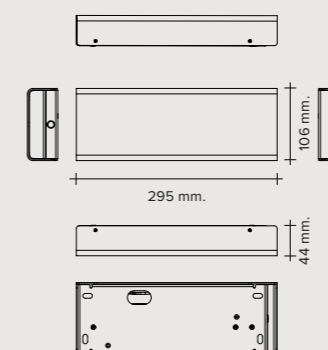

DRIVER BOX S

xxxx.B1
xxxx.B2
xxxx.B4

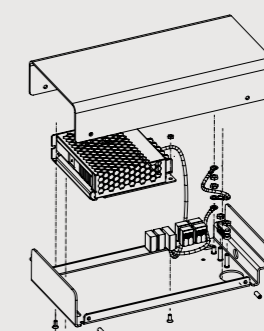
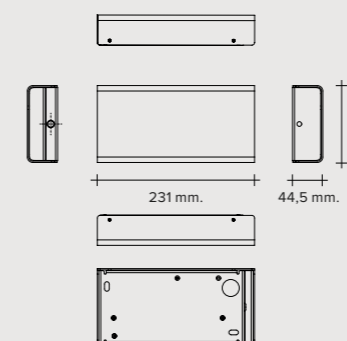

CANOPY

xxxx.M4



Go to the page(s) specified for codes and prices / Vedi codici e prezzi da pag. a pag. / Artikelnummern und Preise siehe Seite bis Seite
Véanse los códigos y precios desde pag. hasta pag. / См. постраничную информацию о кодах и ценах

338 - 339 - 340 - 341

LINEA

VERTICAL SUSPENSION



LINEA

Suspended installation

Installazione a sospensione / Installation als Pendelleuchte / Instalación colgante / Подвесная установка

Vertical assembly

Montaggio verticale
Vertikale Montage
Montaje vertical
Вертикальный монтаж

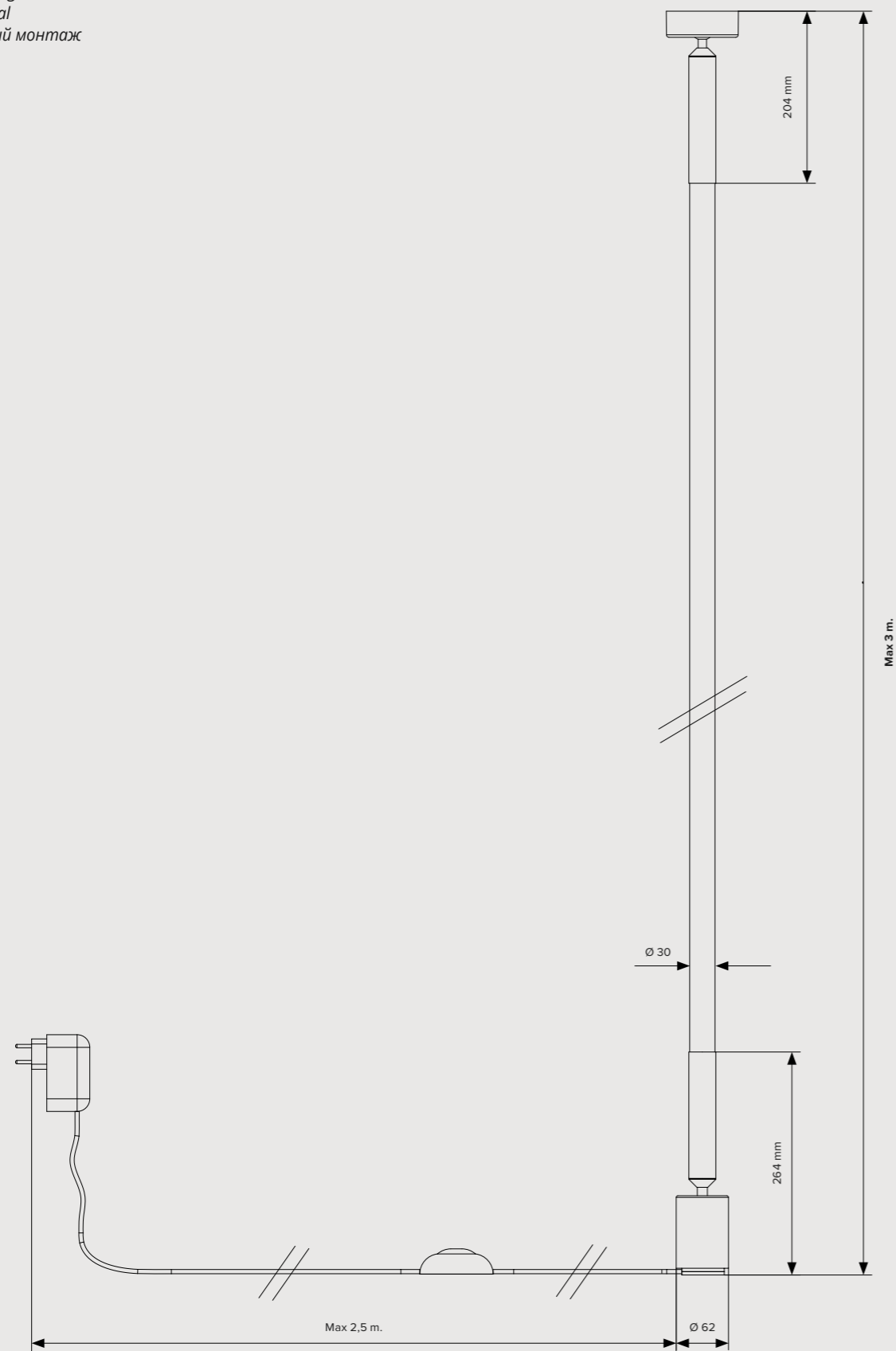

LINEA

System

Linear LED lighting system
Sistema di illuminazione lineare a Led
Lineares LED-Beleuchtungssystem
Sistema de iluminación LED lineal
Линейная светодиодная система освещения



FINISHES / FINITURE / AUSFÜHRUNGEN / ACABADOS / ОТДЕЛКИ

FRAME

Montatura / Rahmen / Estructura / Отделка

- Brushed aluminium / Alluminio spazzolato / Gebürstetes Aluminium / Aluminio cepillado / Крацованный алюминий
- Black / Nero / Schwarz / Negro / Черный
- Sand / Sabbia / Sand / Arena / Песочный

DIFFUSER

Diffusore / Diffusor / Difusor / Рассеиватель

- White opaline silicone / Silicone bianco opalino
Weißes opales Silikon / Silicona blanca opalina / Силикон опаловый белый

LIGHT SOURCE / SORGENTE / LICHTQUELLE / FUENTE LUMINOSA / ИСТОЧНИК СВЕТА

3 m.	LED 60W	48V *	2700°K / 5100 Lumen	CRI 90
			3000°K / 5700 Lumen	CRI 90

* Dimmable - Foot-dimmable. Plug connector

Dimmerabile. Dimmer a piede. Alimentatore a spina
Dimmbar - Fußdimmer. Steckernetzteil
Regulable - Regulador de intensidad de pie. Fuente de alimentación con enchufe
С регулируемой яркостью. Ножной диммер. Штепсельный блок питания.

LINEA HORIZONTAL SUSPENSION





LINEA

HORIZONTAL SUSPENSION



LINEA HORIZONTAL SUSPENSION



Suspended installation

Installazione a sospensione / Installation als Pendelleuchte / Instalación colgante / Подвесная установка

Horizontal assembly
 Montaggio orizzontale
 Horizontale Montage
 Montaje horizontal
 Горизонтальный монтаж

S1

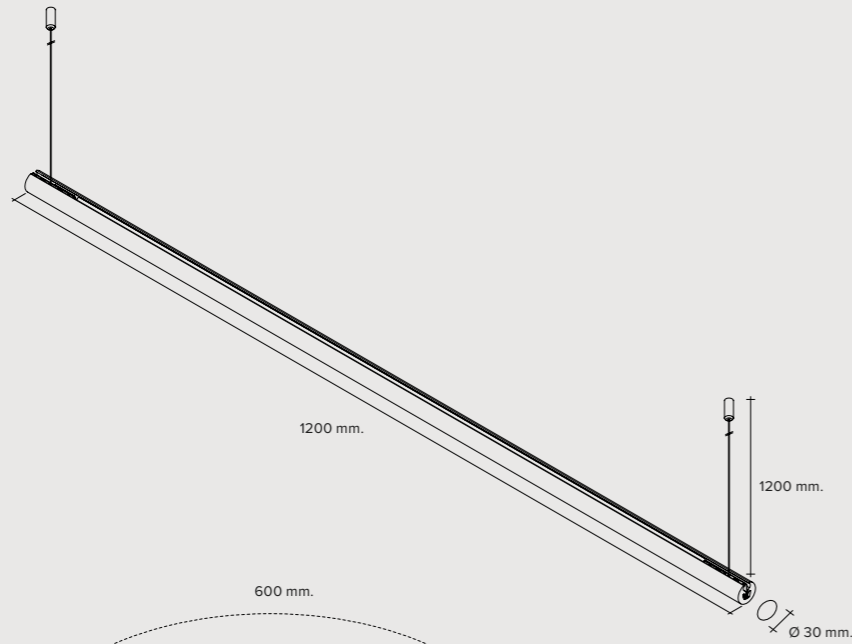

S2

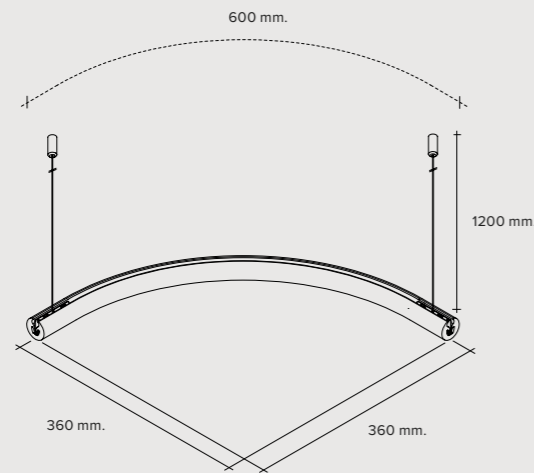

S3

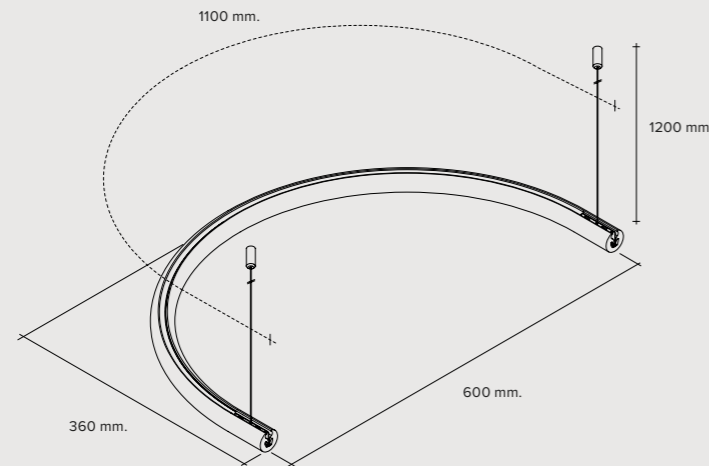

* Power cable: 2 m. Steel core elements cannot be cut to measure

Cavo di alimentazione: 2 m. Elementi con anima in acciaio non sezionabili a misura

Stromversorgungskabel: 2 m. Elemente mit Stahlkern, die nicht auf Maß geschnitten werden können

Cable de alimentación: 2 m. Los elementos con núcleo de acero, no pueden cortarse a medida

Шнур питания: 2 м. Элементы со стальным сердечником, резка по индивидуальному размеру невозможна.

LINEA

System

Linear LED lighting system

Sistema di illuminazione lineare a Led

Lineares LED-Beleuchtungssystem

Sistema de iluminación LED lineal

Линейная светодиодная система освещения



FINISHES / FINITURE / AUSFÜHRUNGEN / ACABADOS / ОТДЕЛКИ

FRAME - CEILING CANOPIES - DRIVER BOX

Montatura - Rosoni - Driver Box / Rahmen - Baldachine - Driver Box / Estructura - Rosetones - Caja de controladores
 Каркас - Основания - Коробки для драйверов

- Brushed aluminium / Alluminio spazzolato / Gebürstetes Aluminium / Aluminio cepillado / Крацованный алюминий
- Black / Nero / Schwarz / Negro / Черный
- Sand / Sabbia / Sand / Arena / Песочный

DIFFUSER

Diffusore / Diffusor / Difusor / Рассеиватель

- White opaline silicone / Silicone bianco opalino / Weißes opales Silikon / Silicona blanca opalin / Силикон молочный белый

LIGHT SOURCE / SORGENTE / LICHTQUELLE / FUENTE LUMINOSA / ИСТОЧНИК СВЕТА

Model	Power	Voltage	Color Temperature	Lumen	CRI
S1	LED 24W	48V	2700°K	2040 Lumen	CRI 90
			3000°K	2280 Lumen	CRI 90
S2	LED 12W	48V	2700°K	1020 Lumen	CRI 90
			3000°K	1140 Lumen	CRI 90
S3	LED 22W	48V	2700°K	1870 Lumen	CRI 90
			3000°K	2090 Lumen	CRI 90

DRIVER BOX L

xxxx.B3
 xxxx.B5
 xxxx.B6

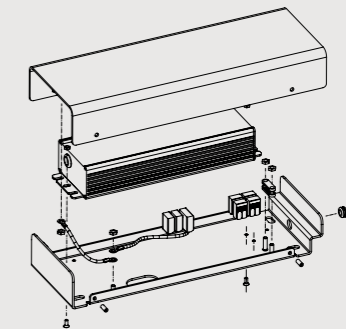
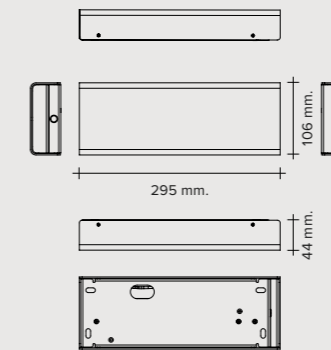

DRIVER BOX S

xxxx.B1
 xxxx.B2
 xxxx.B4

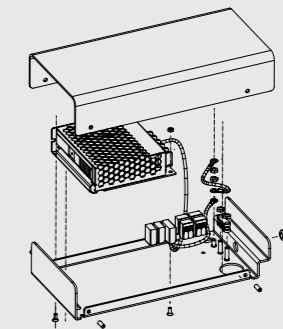
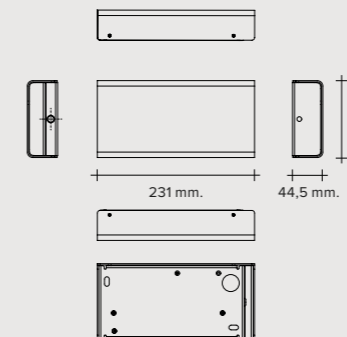

CANOPIE

xxxx.M4



Ø 85

Go to the page(s) specified for codes and prices / Vedi codici e prezzi da pag. a pag. / Artikelnummern und Preise siehe Seite bis Seite
 Véanse los códigos y precios desde pag. hasta pag. / См. страничную информацию о кодах и ценах

Set-up and components

Configurazione e componenti / Konfigurationen und Komponenten / Configuraciones y componentes / Компоновка и детали

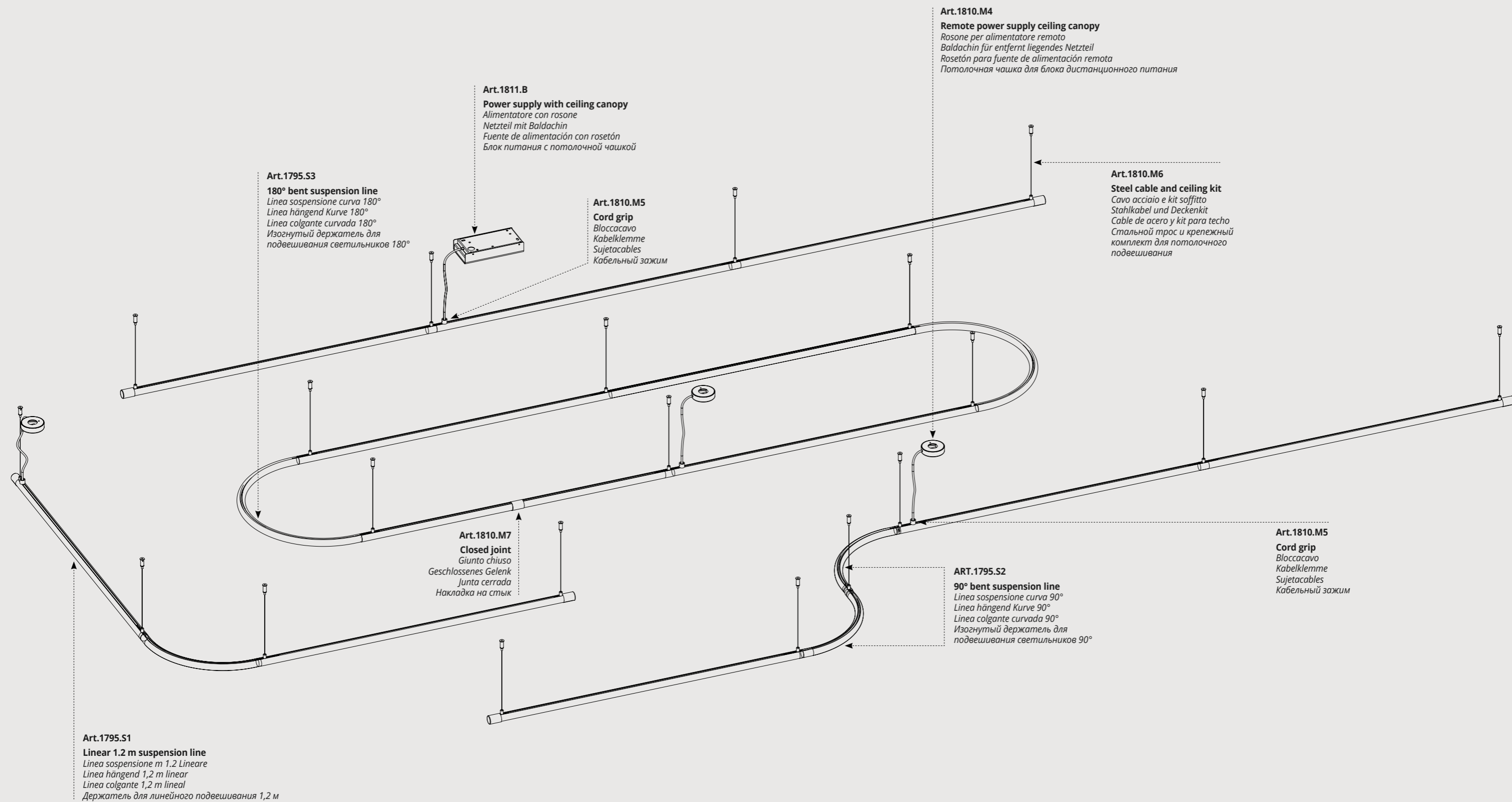

LAMOI

Andrea Barra

LAMOI

The light that amazes, fascinates and involves is a theme that the Lamoi LED lamp series interprets with ethereal personality. The current-conducting metal powers and switches on the 1w LED modules. Available in the 2700°K and 3000°K versions. Dimmable and non-dimmable, with or without covers.

LAMOI

La luce che stupisce, affascina e coinvolge è un tema che la serie di lampade a led, Lamoi interpreta con eterea personalità. Il metallo conduttore di corrente alimenta e accende i moduli led da 1 w. Disponibili in 2700°K e 3000°K. Dimmerabile e non, con o senza coperture.

LAMOI

Licht, das erstaunt, fasziniert und mitreißt, ist ein Thema, das die LED-Lampenserie Lamoi mit ätherischer Persönlichkeit interpretiert. Das stromleitende Metall versorgt die 1-W-LED-Module mit Strom und schaltet sie ein. Erhältlich in 2700°K und 3000°K. Dimmbar und nicht dimmbar, mit oder ohne Abdeckung.

LAMOI

La luz que asombra, fascina y envuelve es un tema que la serie de lámparas LED, Lamoi, interpreta con personalidad etérea. El metal conductor de corriente alimenta y enciende los módulos LED de 1 W. Disponible en 2700°K y 3000°K. Regulable y no regulable, con o sin cubiertas.

LAMOI

Свет, который удивляет, завораживает и привлекает: серия светодиодных светильников Lamoi представляет собой переосмысление этой темы, несущее на себе печать воздушной оригинальности. Токпроводящий металл подает питание на светодиодные модули мощностью 1 Вт. Доступны версии 2700°K и 3000°K, с и без диммера, с крышками и без.

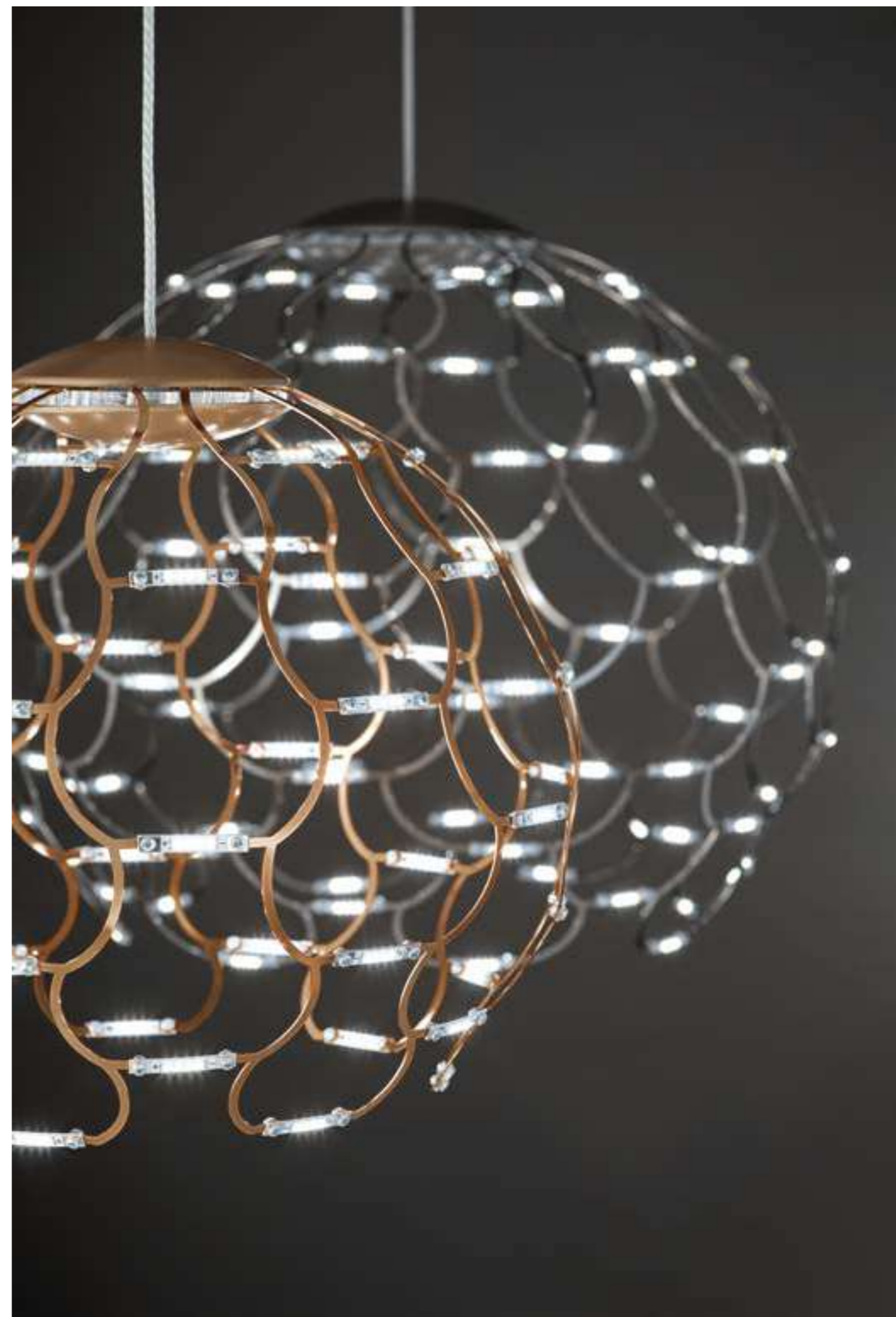



LAMOI

SUSPENSION



LAMOI SUSPENSION

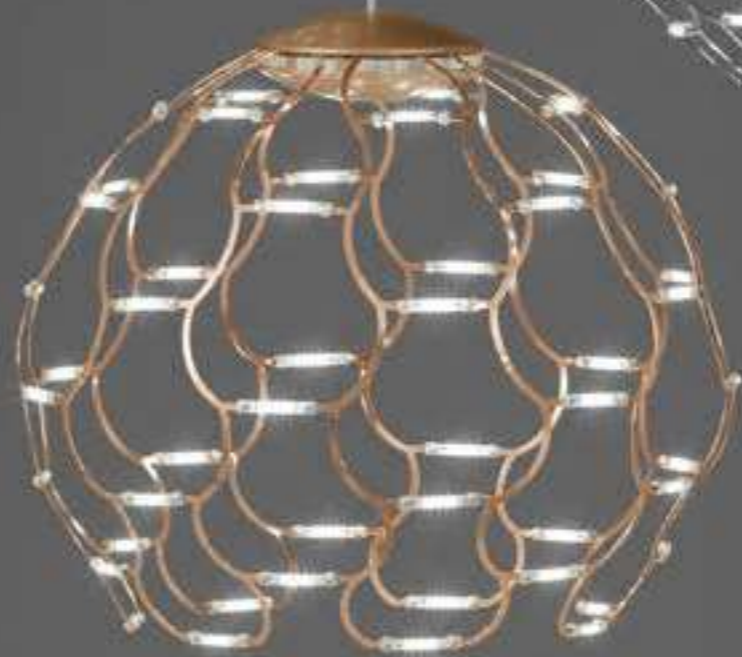
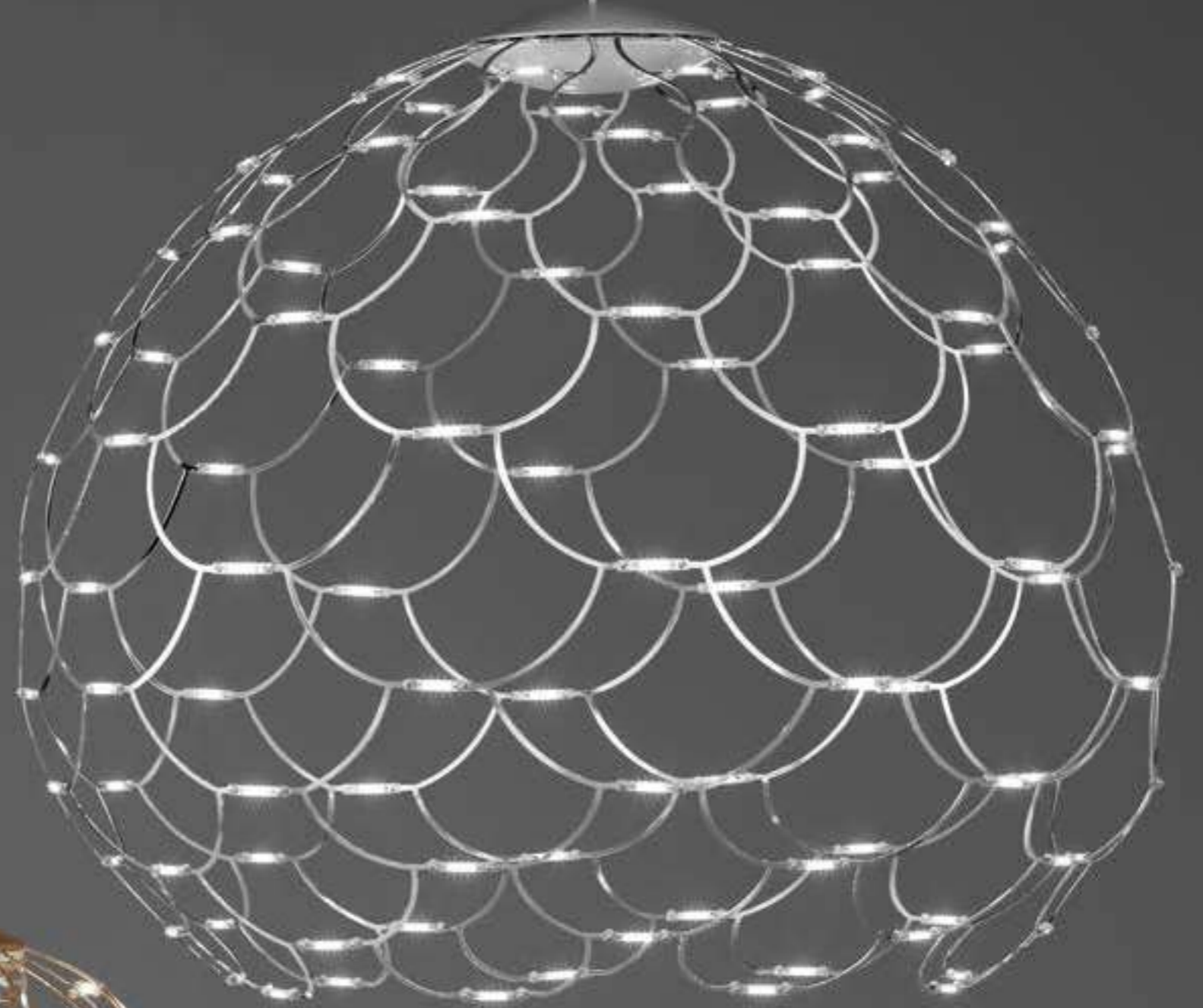
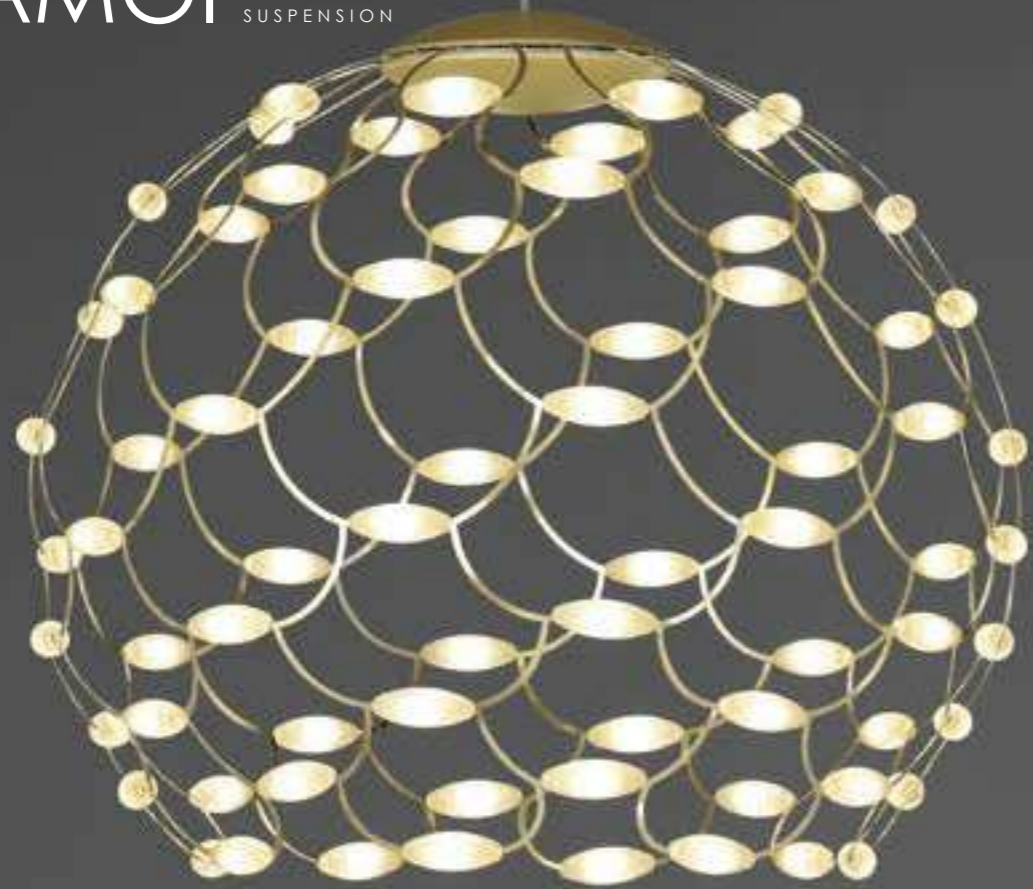



LAMOI

SUSPENSION



LAMOI 2.0 SUSPENSION



LAMOI 2.0 SUSPENSION



LAMOI 2.0 SUSPENSION



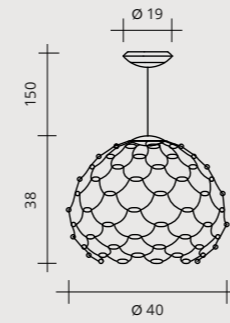

49W - 24V LED
2700°K / 5468 lumen
3000°K / 6076 lumen

Versions:

On-Off

Push
Dali
0-10v
1-10v

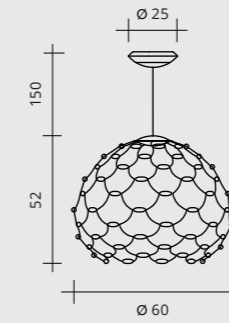

72W - 24V LED
2700°K / 8035 lumen
3000°K / 8928 lumen

Versions:

On-Off

Push
Dali
0-10v
1-10v

Triac

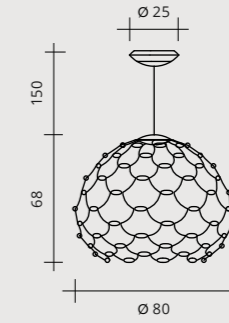

99W - 24V LED
2700°K / 9939 lumen
3000°K / 11044 lumen

Versions:

On-Off

Push
Dali
0-10v
1-10v

LAMOI Suspension lamp

Lampada a sospensione
Pendelleuchte
Lámpara colgante
Подвесной светильник



FINISHES / FINITURE / AUSFÜHRUNGEN / ACABADOS / ОТДЕЛКИ

- Copper / Rame / Kupfer / Cobre / Медь
- Chrome / Cromo / Chrom / Cromo / Хром
- Gold / Oro / Gold / Oro / Золото

LAMOI 2.0 Suspension lamp

Lampada a sospensione
Pendelleuchte
Lámpara colgante
Подвесной светильник



FINISHES / FINITURE / AUSFÜHRUNGEN / ACABADOS / ОТДЕЛКИ

- Matt black / Nero opaco / Mattschwarz / Negro mate / Матовый черный

Go to the page(s) specified for codes and prices / Vedi codici e prezzi da pag. a pag. / Artikelnummern und Preise siehe Seite bis Seite
Véanse los códigos y precios desde pag. hasta pag. / См. постраничную информацию о кодах и ценах



LAMOI CEILING

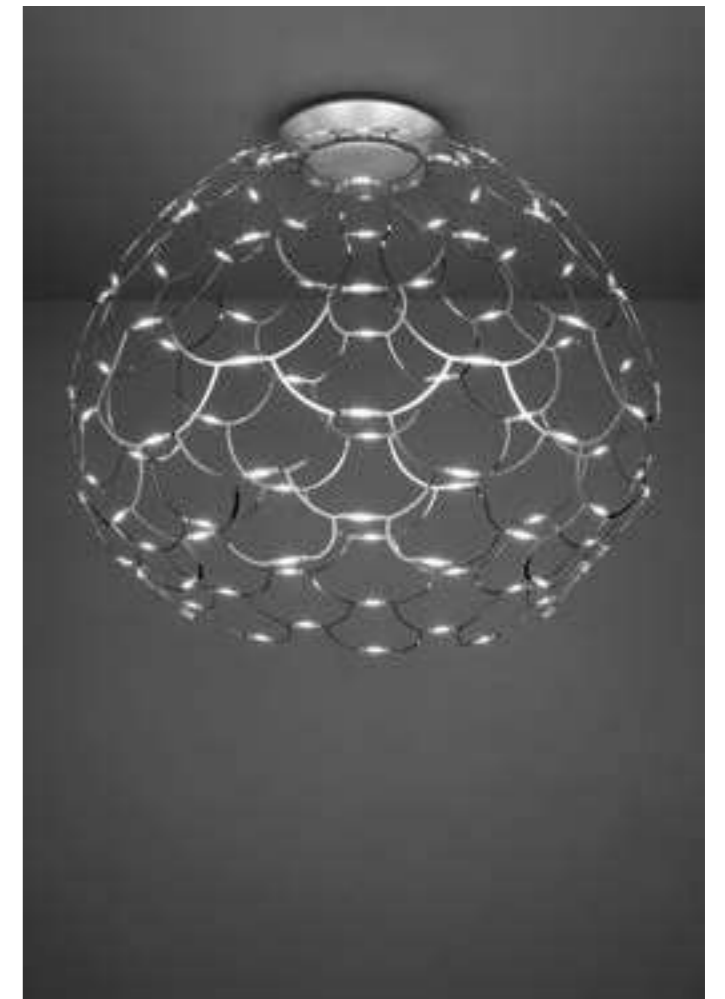

LAMOI CEILING



LAMOI

LAMOI 2.0 CEILING

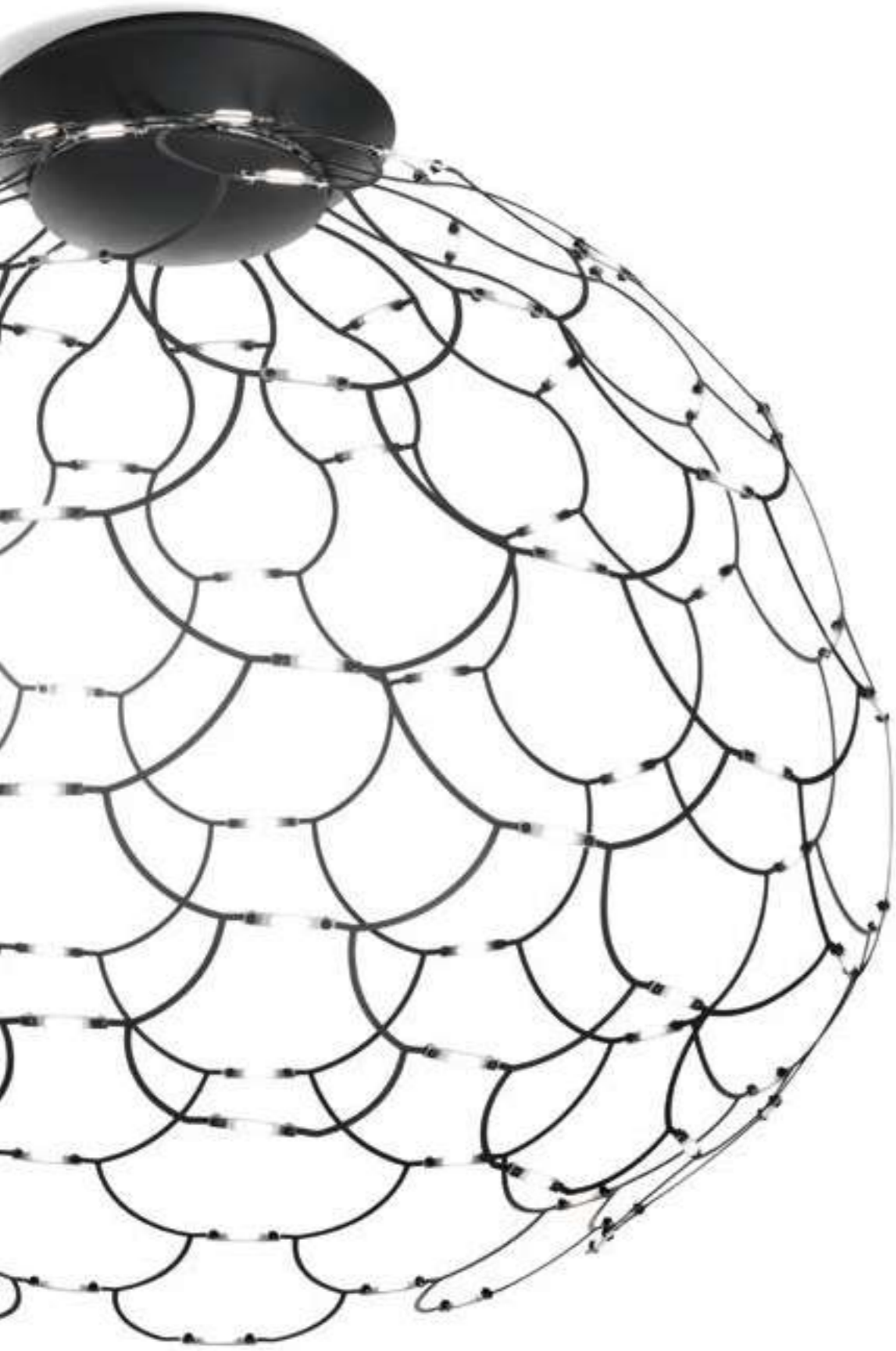

LAMOI 2.0 CEILING



LAMOI 2.0 CEILING



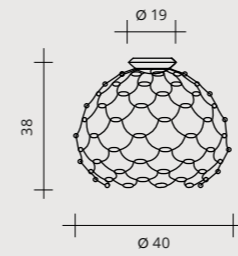

49W - 24V LED
2700°K / 5468 lumen
3000°K / 6076 lumen

Versions:

On-Off

Push
Dali
0-10v
1-10v

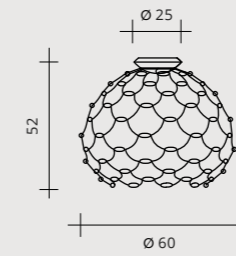

72W - 24V LED
2700°K / 8035 lumen
3000°K / 8928 lumen

Versions:

On-Off

Push
Dali
0-10v
1-10v

Triac

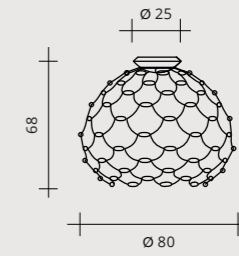

99W - 24V LED
2700°K / 9939 lumen
3000°K / 11044 lumen

Versions:

On-Off

Push
Dali
0-10v
1-10v

LAMOI

Ceiling lamp

Lampada da soffitto

Deckenleuchte

Lámpara de techo

Потолочный светильник



FINISHES / FINITURE / AUSFÜHRUNGEN / ACABADOS / ОТДЕЛКИ

- Copper / Rame / Kupfer / Cobre / Медь
- Chrome / Cromo / Chrom / Cromo / Хром
- Gold / Oro / Gold / Oro / Золото

LAMOI 2.0

Ceiling lamp

Lampada da soffitto

Deckenleuchte

Lámpara de techo

Потолочный светильник



FINISHES / FINITURE / AUSFÜHRUNGEN / ACABADOS / ОТДЕЛКИ

- Matt black / Nero opaco / Mattschwarz / Negro mate / Матовый черный

Go to the page(s) specified for codes and prices / Vedi codici e prezzi da pag a pag. / Artikelnummern und Preise siehe Seite bis Seite / Véanse los códigos y precios desde pag. hasta pag. / См. постраничную информацию о кодах и ценах

348 - 349 - 351

LAMOI FLOOR



LAMOI

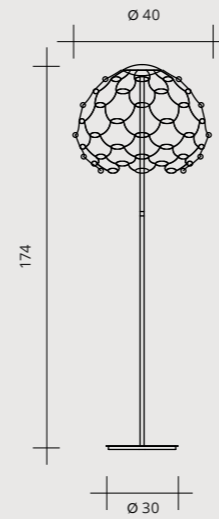

49W - 24V LED
2700°K / 5468 lumen
3000°K / 6076 lumen

LAMOI

Floor lamp

Floor lamp. Footswitch dimmer included.

Lampada da terra, dimmer a pedale incluso.

Stehleuchte. Inklusive Fußdimmer.

Lámpara de pie. Regulador de intensidad con pedal incluido.

Напольный светильник. В комплект входит диммер с ножным управлением.



FINISHES / FINITURE / AUSFÜHRUNGEN / ACABADOS / ОТДЕЛКИ

● Copper / Rame / Kupfer / Cobre / Медь

● Chrome / Cromo / Chrom / Cromo / Хром

● Gold / Oro / Gold / Oro / Золото

TESA

Marco Spatti

TESA

A shining microcosm.
Star-like points of light,
suspended in a harmonious
and balanced geometric orbit.
Both the large Tesa version and the
mini version convey a sense of lightness,
appeal, intimacy and personality.
LED and metal structure in a single
body enhance an elegant lamp of solids
and voids, sparkles and reflections,
with a strong visual impact.
Available in the 2700°k
and 3000°k version.
Dimmable and non-dimmable.



TESA

*Un microcosmo splendente.
Punti di luce, quasi stelle,
sospesi in un'orbita geometrica
armonica ed equilibrata.
Sia la versione grande Tesa che
Tesa mini, esprimono leggerezza,
appeal, intimità e personalità.
Led e struttura metallica in corpo
unico esaltano una lampada
elegante, di pieni e di vuoti, scintillii
e riflessi, dal forte impatto visivo.
Disponibile 2700°k e 3000°k.
Dimmerabile e non.*

TESA

*Ein leuchtender Mikrokosmos.
Lichtpunkte, fast Sterne,
die in einer harmonischen und
ausgewogenen geometrischen
Umlaufbahn schweben.
Sowohl die große Tesa-Version
als auch die Tesa Mini, drücken
Leichtigkeit, Attraktivität, Intimität
und Persönlichkeit aus. Die LED und
die Metallstruktur in einem einzigen
Gehäuse ergeben eine elegante
Leuchte mit einer Mischung aus
Voll- und Hohlräumen, Glitzern und
Reflexen, die eine starke visuelle
Wirkung hat. Erhältlich in 2700°k
und 3000°k. Dimmbar und nicht
dimmbar.*

TESA

*Un microcosmos brillante.
Puntos de luz, casi estrellas,
suspendidos en una órbita
geométrica armoniosa y equilibrada.
Tanto la versión grande de Tesa
como Tesa mini, expresan ligereza,
atracción, intimidad y personalidad.
LED y estructura metálica en un solo
cuerpo realzan una elegante lámpara
de volúmenes llenos y vacíos, destellos
y reflejos, con un gran impacto visual.
Disponibile en 2700°k y 3000°k.
Regulable y no regulable.*

TESA

*Сияющий микрокосмос.
Светящиеся точки, почти звезды,
«подвешенные» на гармонично
сбалансированной геометрической
орбите. Tesa в большом формате,
а также Tesa в мини-версии являются
олицетворением легкости,
притягательной силы, уюта
и оригинальности. Светодиоды и
металлический монолитный корпус
образуют необычайно эффектный и
элегантный светильник, сотканный
из полных и пустых объемов, искр
и бликов. Доступны версии 2700°k и
3000°k с и без диммера.*









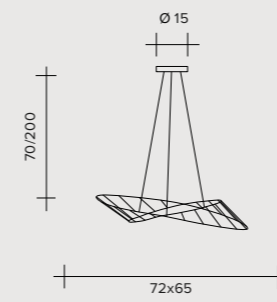

20W - 24V LED
2700°K / 2232 lumen
3000°K / 2480 lumen

Versions:

On-Off

Push
Dali
0-10v
1-10v

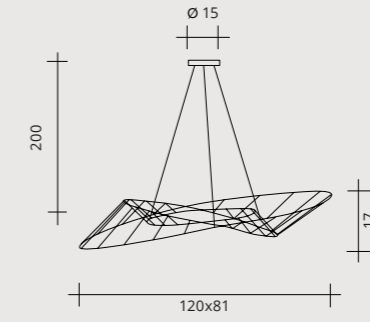

40W - 24V LED
2700°K / 4464 lumen
3000°K / 4960 lumen

Versions:

On-Off

Push
Dali
0-10v
1-10v

TESA

Suspension lamp

Lampada a sospensione

Pendelleuchte

Lámpara colgante

Подвесной светильник



FINISHES / FINITURE / AUSFÜHRUNGEN / ACABADOS / ОТДЕЛКИ

- Matt powder pink / Cipria opaco / Puderrosa matt
Rosa palo mate / Пудровый матовый
- Matt copper / Rame opaco / Kupfer matt
Cobre mate / Медный матовый

TESA CEILING



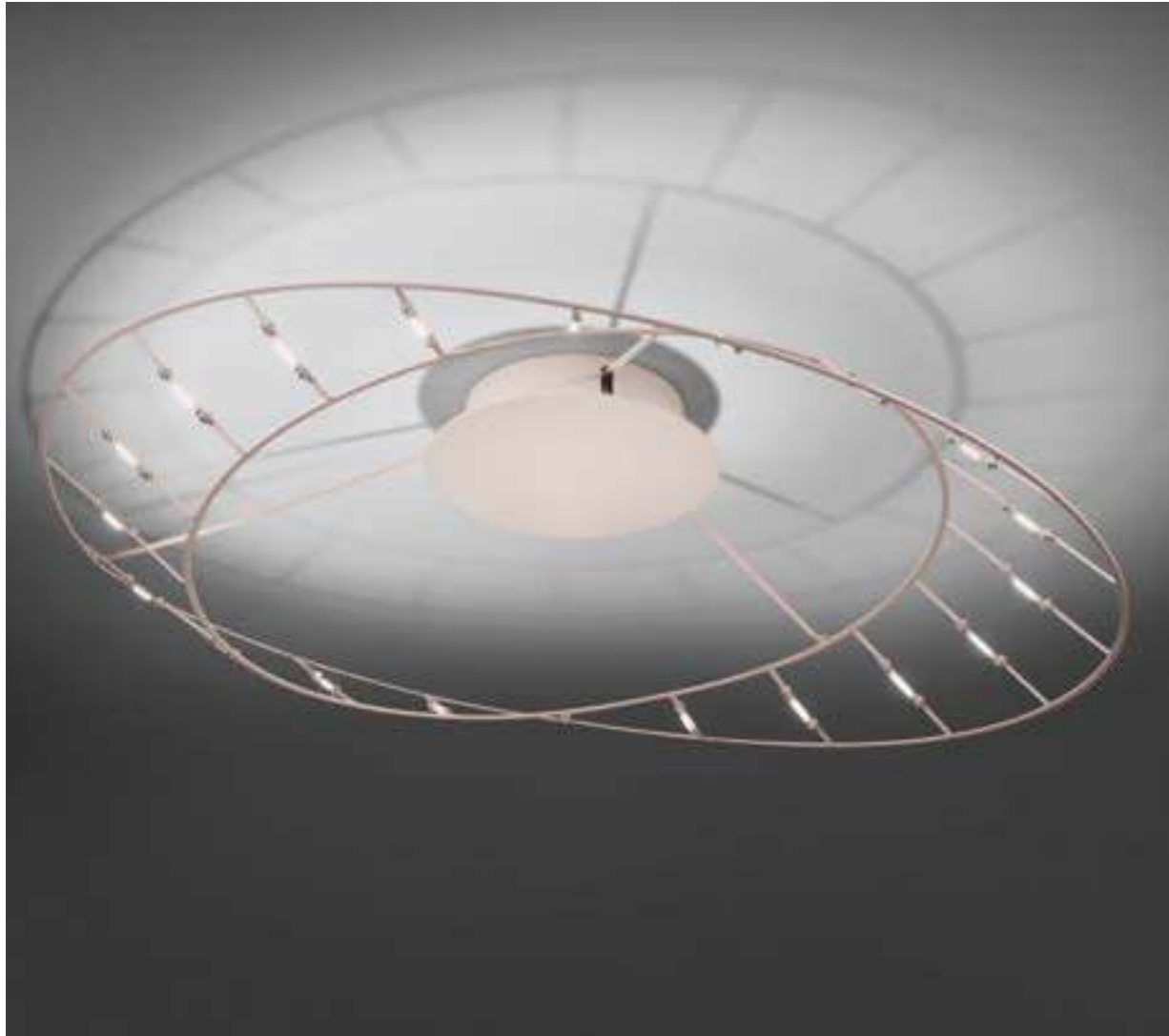

TESA CEILING

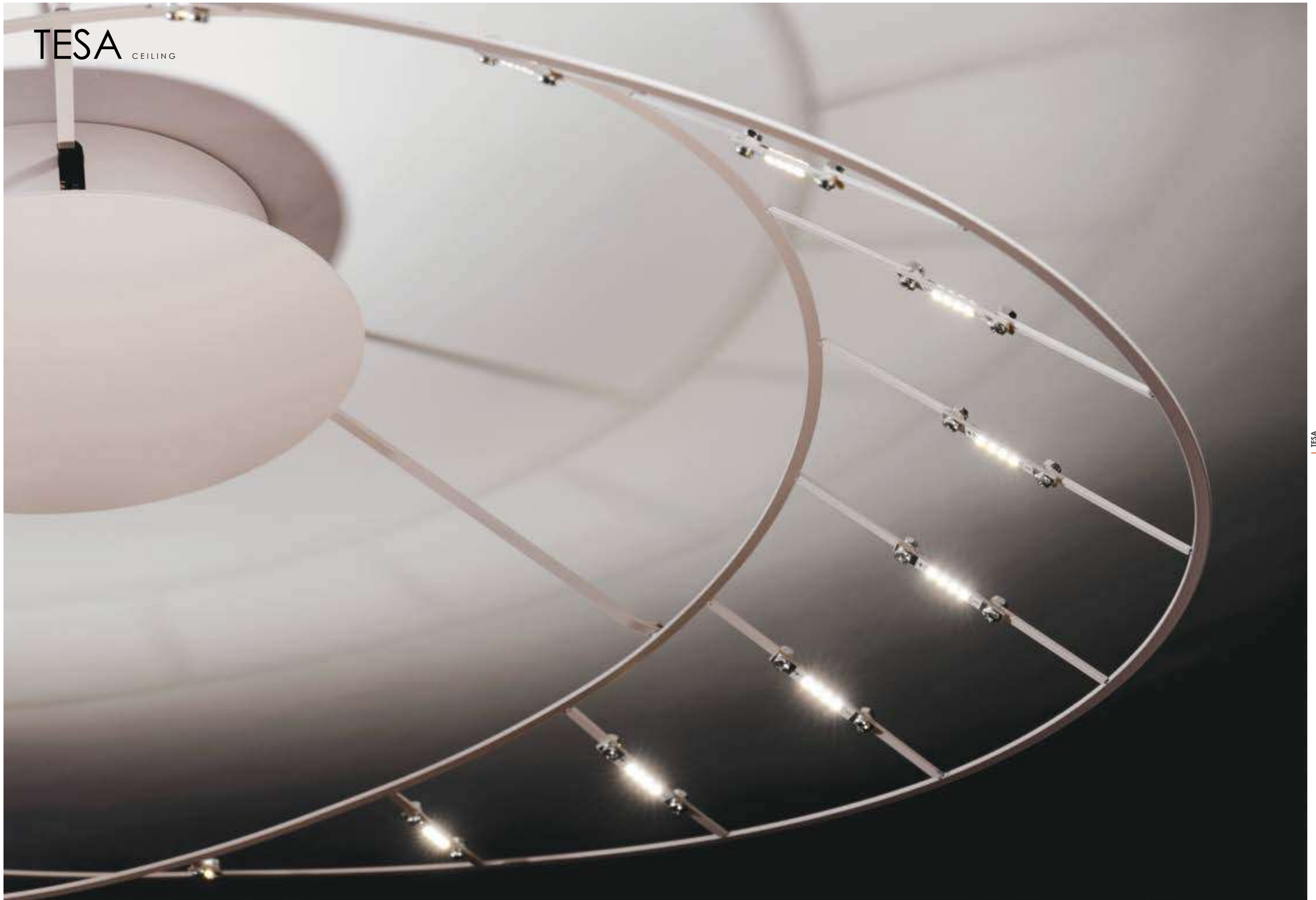

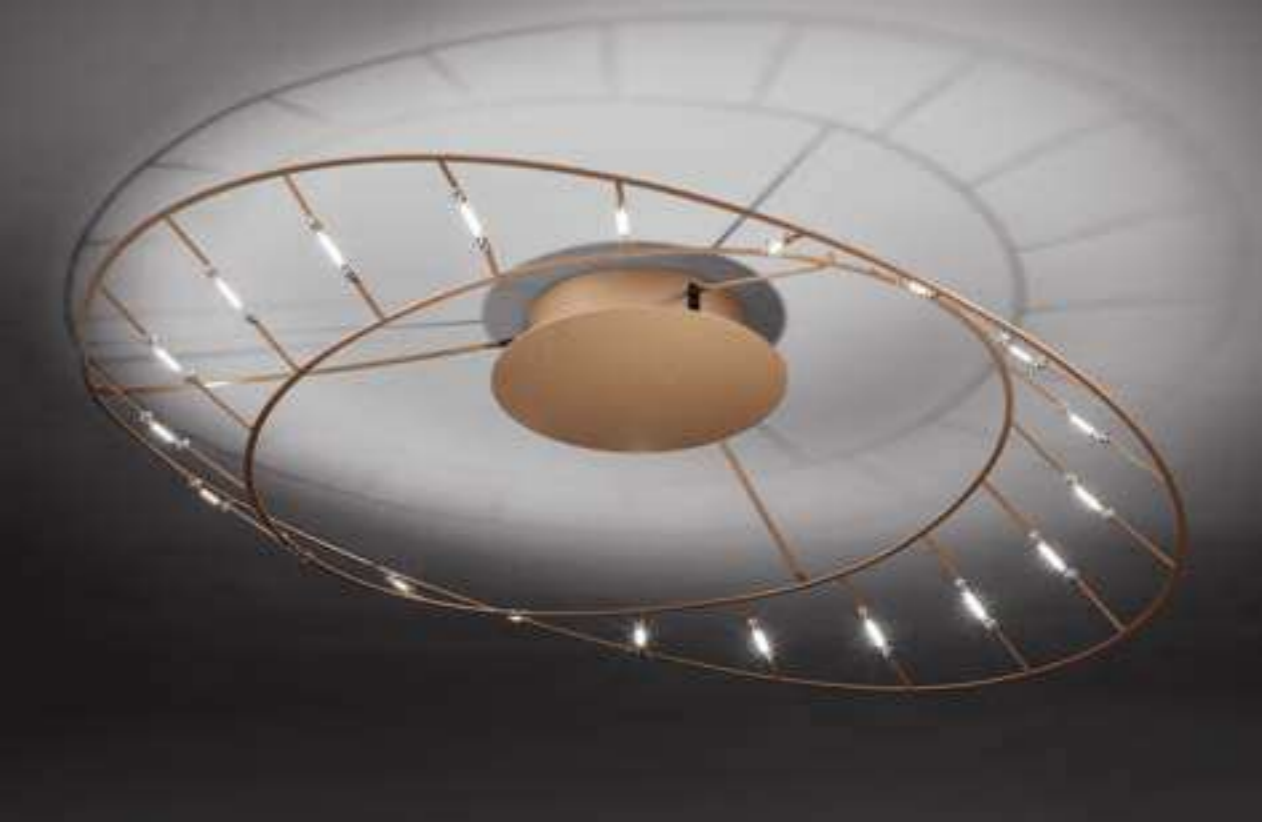
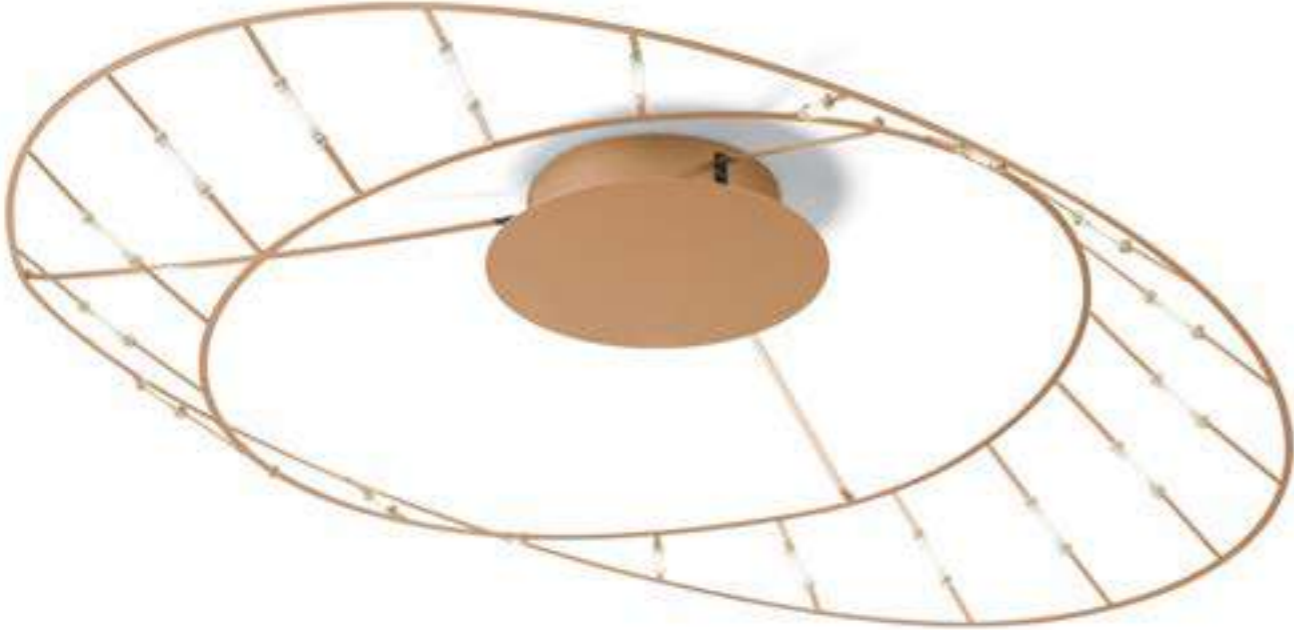



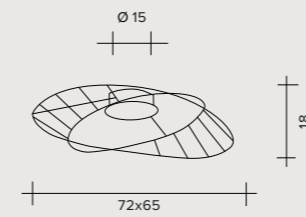
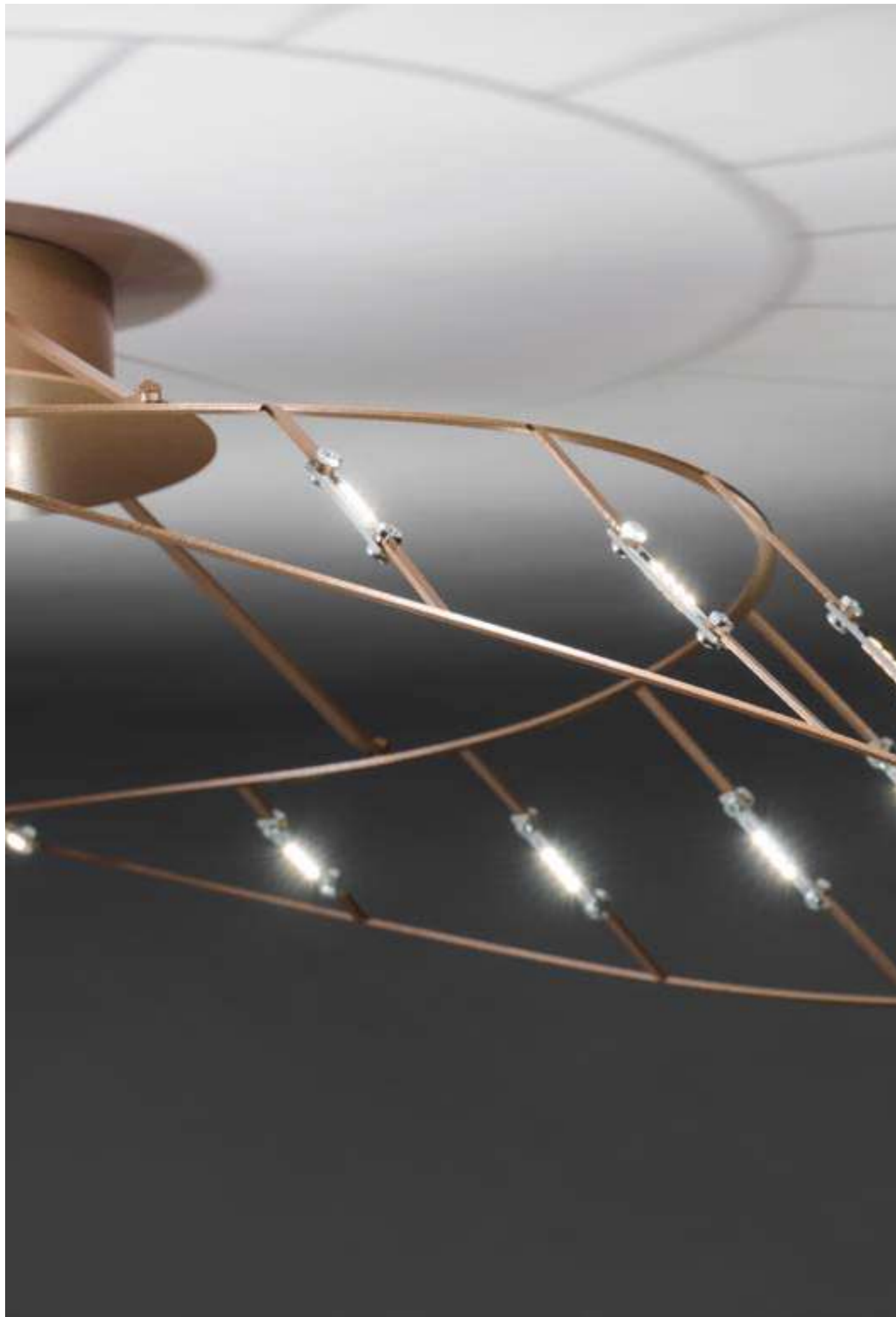

20W - 24V LED
2700°K / 2232 lumen
3000°K / 2480 lumen

Versions:

On-Off

Push
Dali
0-10v
1-10v

TESA

Ceiling lamp

Lampada da soffitto
Deckenleuchte
Lámpara de techo
Потолочный светильник



FINISHES / FINITURE / AUSFÜHRUNGEN / ACABADOS / ОТДЕЛКИ

- Matt powder pink / Cipria opaco / Puderrosa matt
Rosa palo mate / Пудровый матовый
- Matt copper / Rame opaco / Kupfer matt
Cobre mate / Медный матовый



TESA 2.0 SUSPENSION

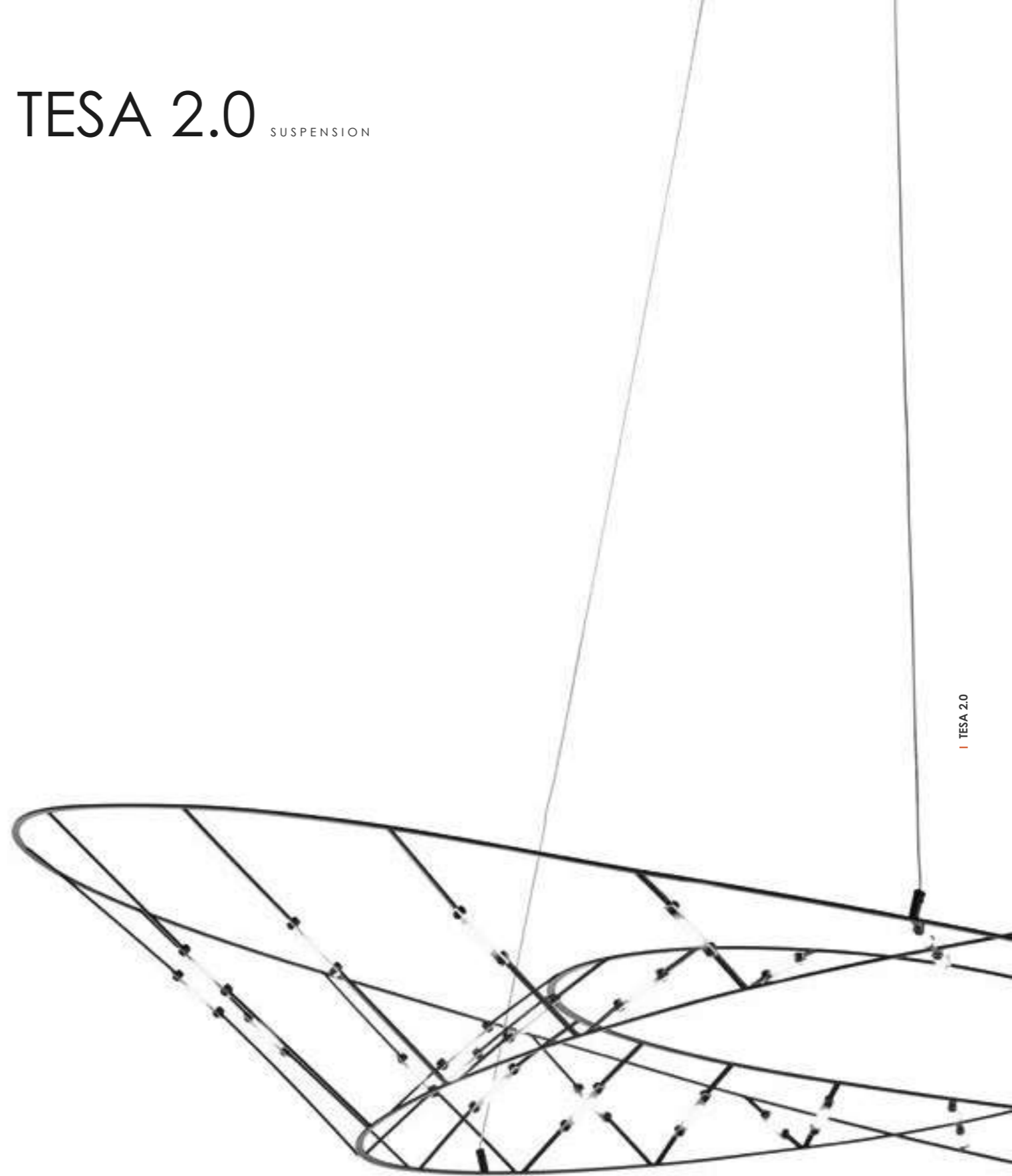

TESA 2.0 SUSPENSION

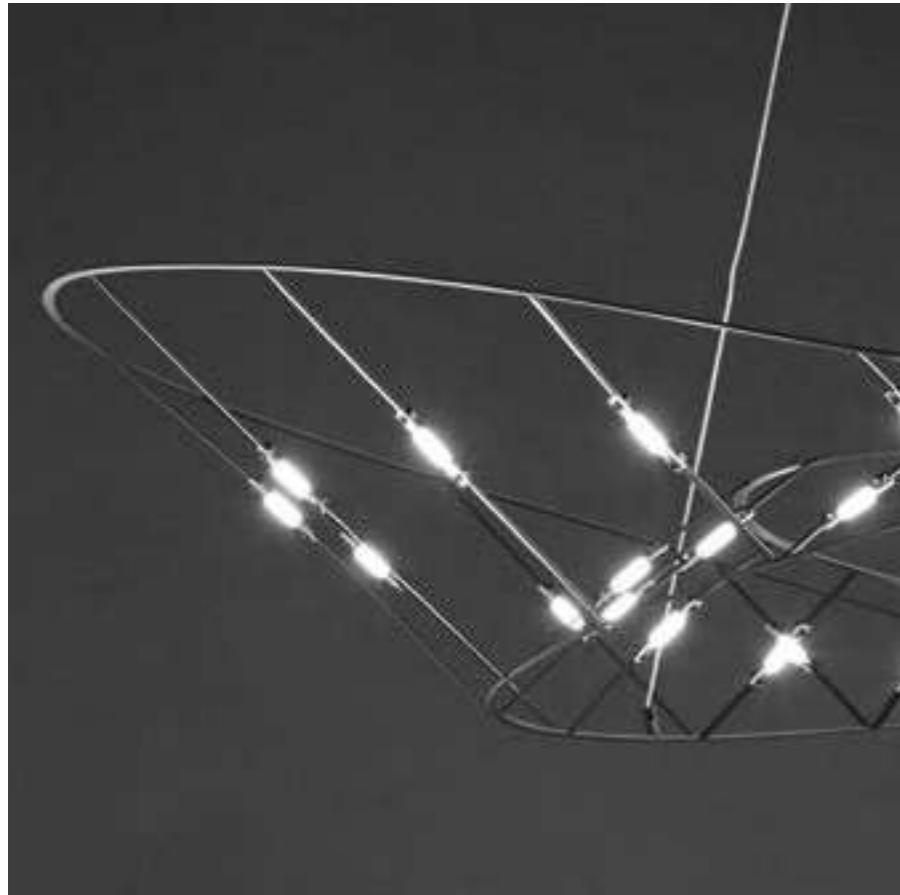

TESA 2.0 SUSPENSION



TESA 2.0 SUSPENSION

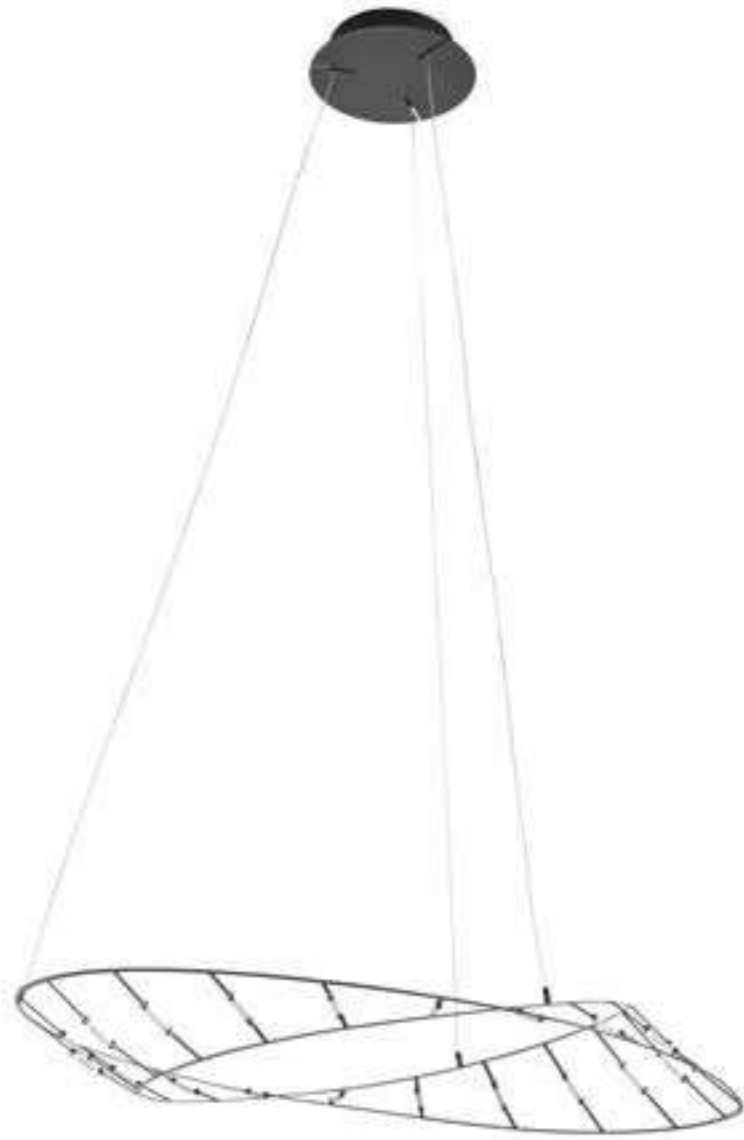

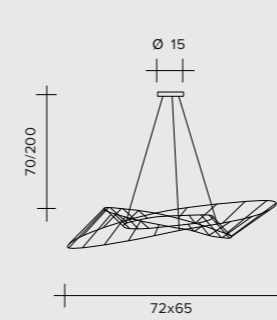

20W - 24V LED
2700°K / 2232 lumen
3000°K / 2480 lumen

Versions:

On-Off

Push
Dali
0-10v
1-10v

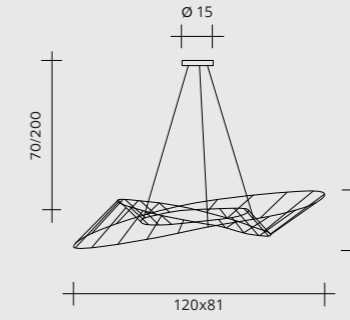

40W - 24V LED
2700°K / 4464 lumen
3000°K / 4960 lumen

Versions:

On-Off

Push
Dali
0-10v
1-10v

TESA 2.0 Suspension lamp

Lampada a sospensione
Pendelleuchte
Lámpara colgante
Подвесной светильник



FINISHES / FINITURE / AUSFÜHRUNGEN / ACABADOS / ОТДЕЛКИ

● Matt black / Nero opaco / Mattschwarz / Negro mate / Матовый черный

TESA 2.0 CEILING

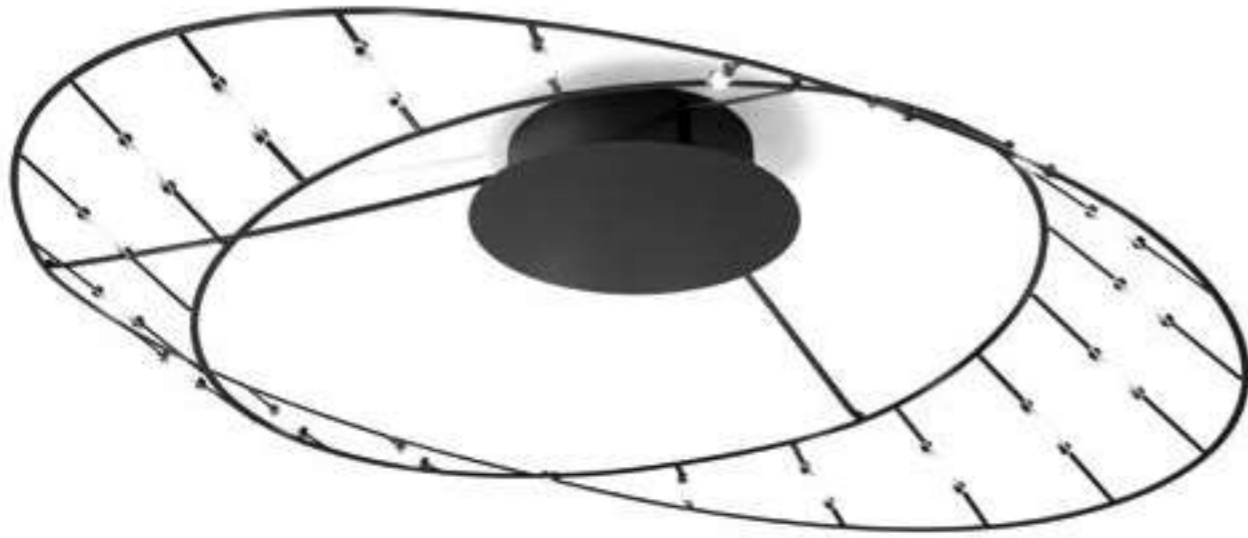

TESA 2.0 CEILING



TESA 2.0 CEILING

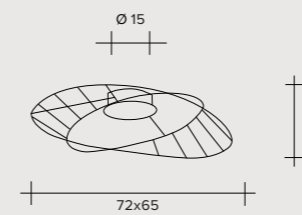
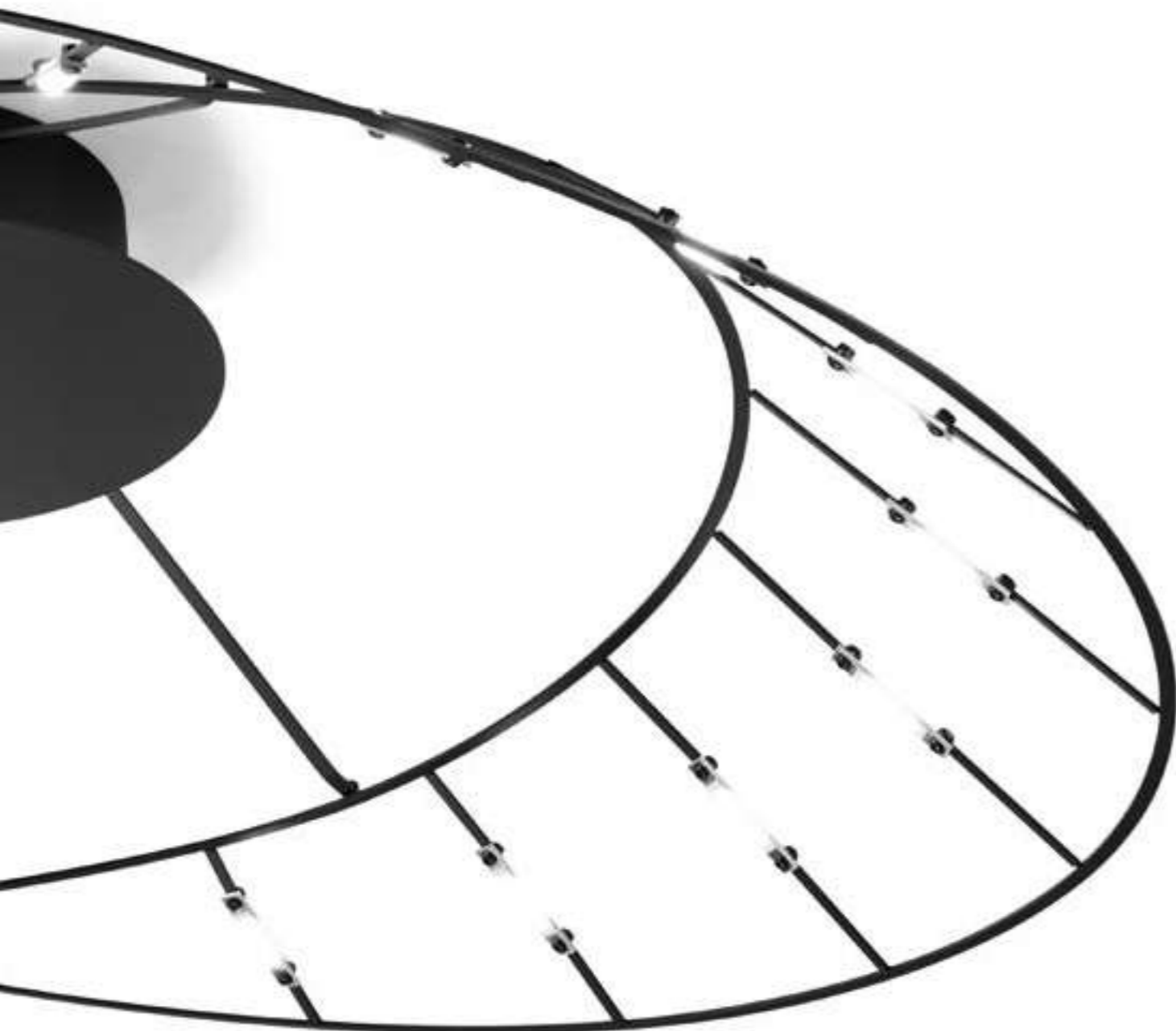

20W - 24V LED
2700°K / 2232 lumen
3000°K / 2480 lumen

Versions:

On-Off

Push
Dali
0-10v
1-10v

TESA 2.0 Ceiling lamp

Lampada da soffitto
Deckenleuchte
Lámpara de techo
Потолочный светильник



FINISHES / FINITURE / AUSFÜHRUNGEN / ACABADOS / ОТДЕЛКИ

- Matt black / Nero opaco / Mattschwarz / Negro mate / Матовый черный

LAFRA

Andrea Barra

LAFRA

Pure elegance and stylistic innovation.
A family of products
that satisfy the desire for light,
technology and aesthetics.
The current-conducting metal powers
and switches on the 1w LED modules.
Available in the 2700°k and 3000°k version.
Dimmable and non-dimmable,
with covers available as optional accessories.

LAFRA

*Eleganza pura
e innovazione stilistica.
Una famiglia di prodotti
che soddisfano il desiderio di
luce, di tecnologia e di estetica.
Il metallo, conduttore di corrente
alimenta e accende
i moduli led da 1 w.
Disponibile 2700°K e 3000°K.
Dimmerabile e non,
le coperture sono optional.*

LAFRA

*Pure Eleganz und
stilistische Innovation.
Eine Familie von Produkten, die das
Verlangen nach Licht, Technik und
Ästhetik befriedigen.
Das stromführende Metall versorgt
die Schalter an den 1-W-LED-Modulen
mit Strom und schaltet sie ein.
Erhältlich in 2700°k und 3000°k.
Dimmbar und nicht dimmbar,
Abdeckungen sind Optionals.*

LAFRA

*Pura elegancia
e innovación estilística.
Una familia de productos
que satisfacen el deseo de luz,
de tecnología y de estética.
El metal, conductor de corriente,
alimenta y enciende los
módulos LED de 1 W.
Disponibile en 2700°K y 3000°K.
Regulable y no regulable, las
cubiertas son opcionales.*

LAFRA

*Чистая элегантность и
стилистические новшества.
Серия изделий, отражающих
стремление к свету под знаком
технологичности и эстетики.
Токопроводящий металл подает
питание на светодиодные модули
мощностью 1 Вт.
Доступны версии 2700°K и 3000°K,
с и без диммера, крышки являются
опциональными элементами.*



LAFRA CEILING

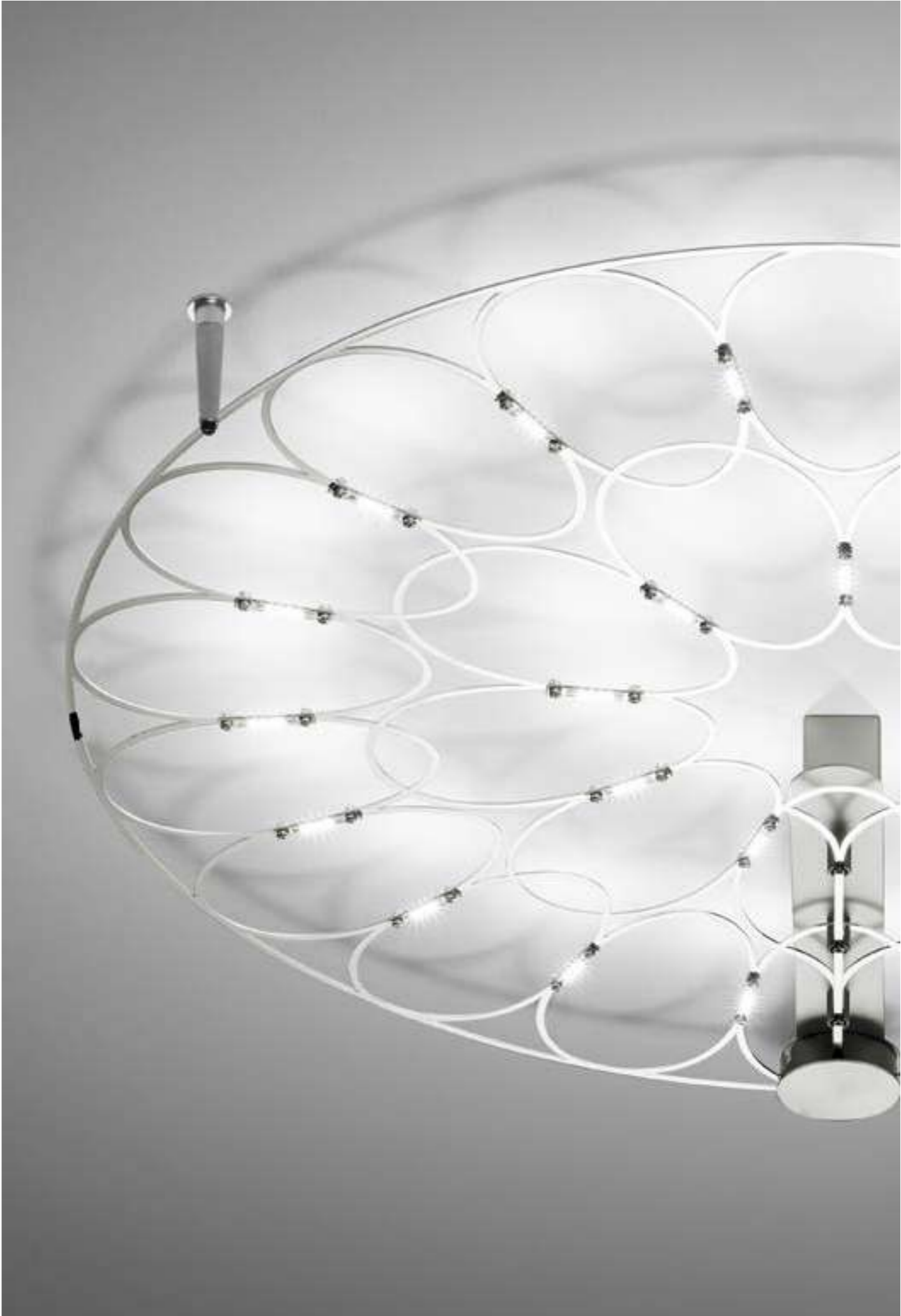

LAFRA



LAFRA

CEILING





LAFRA 2.0 CEILING

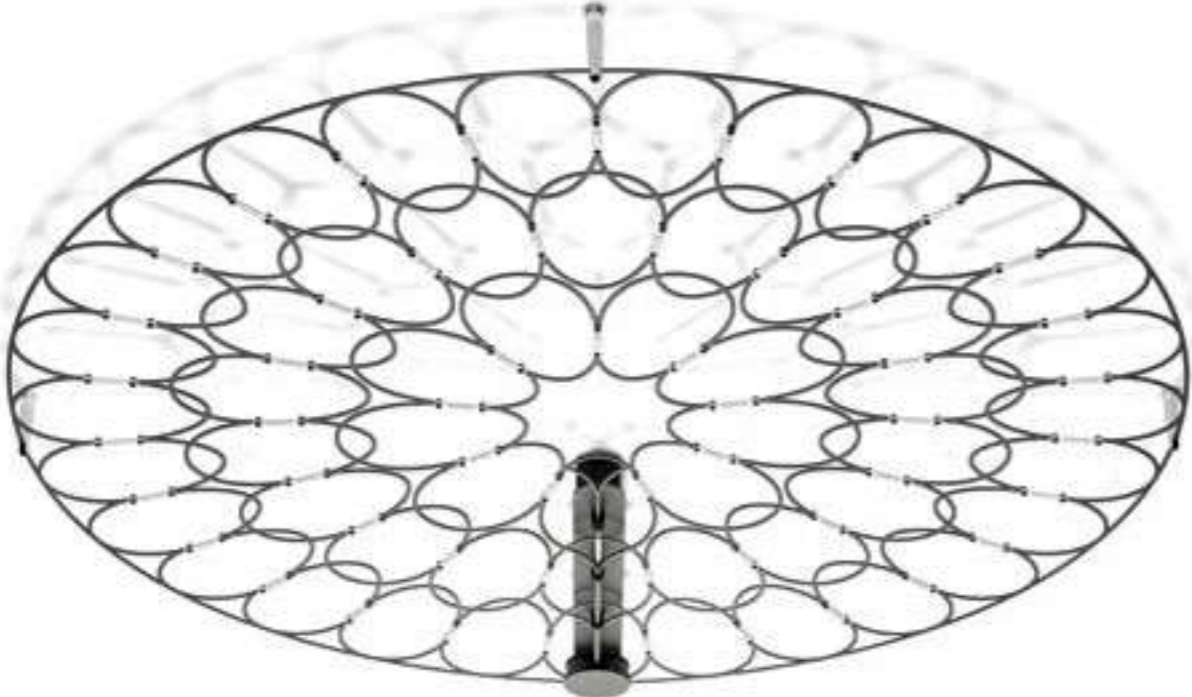

LAFRA 2.0 CEILING

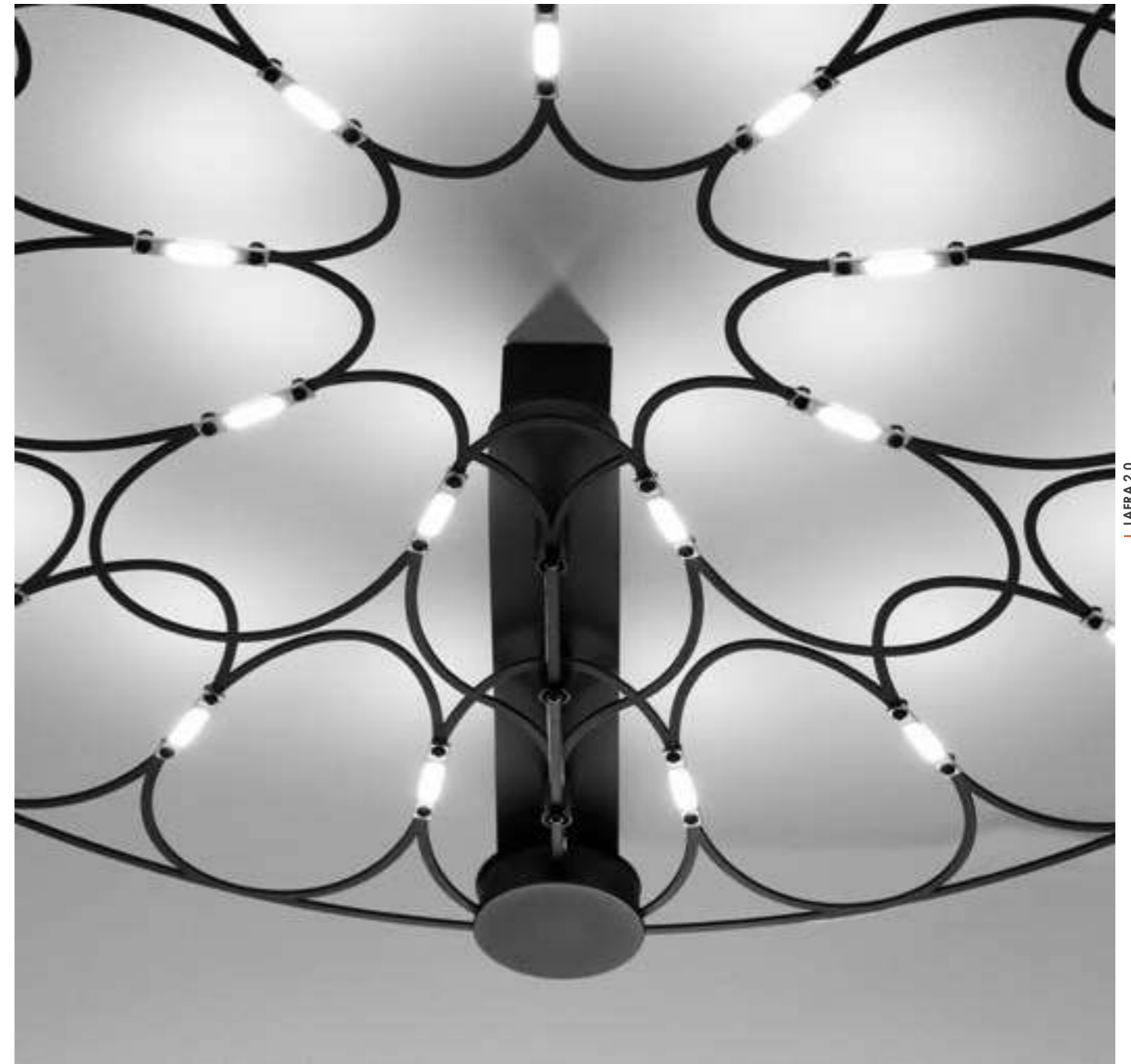

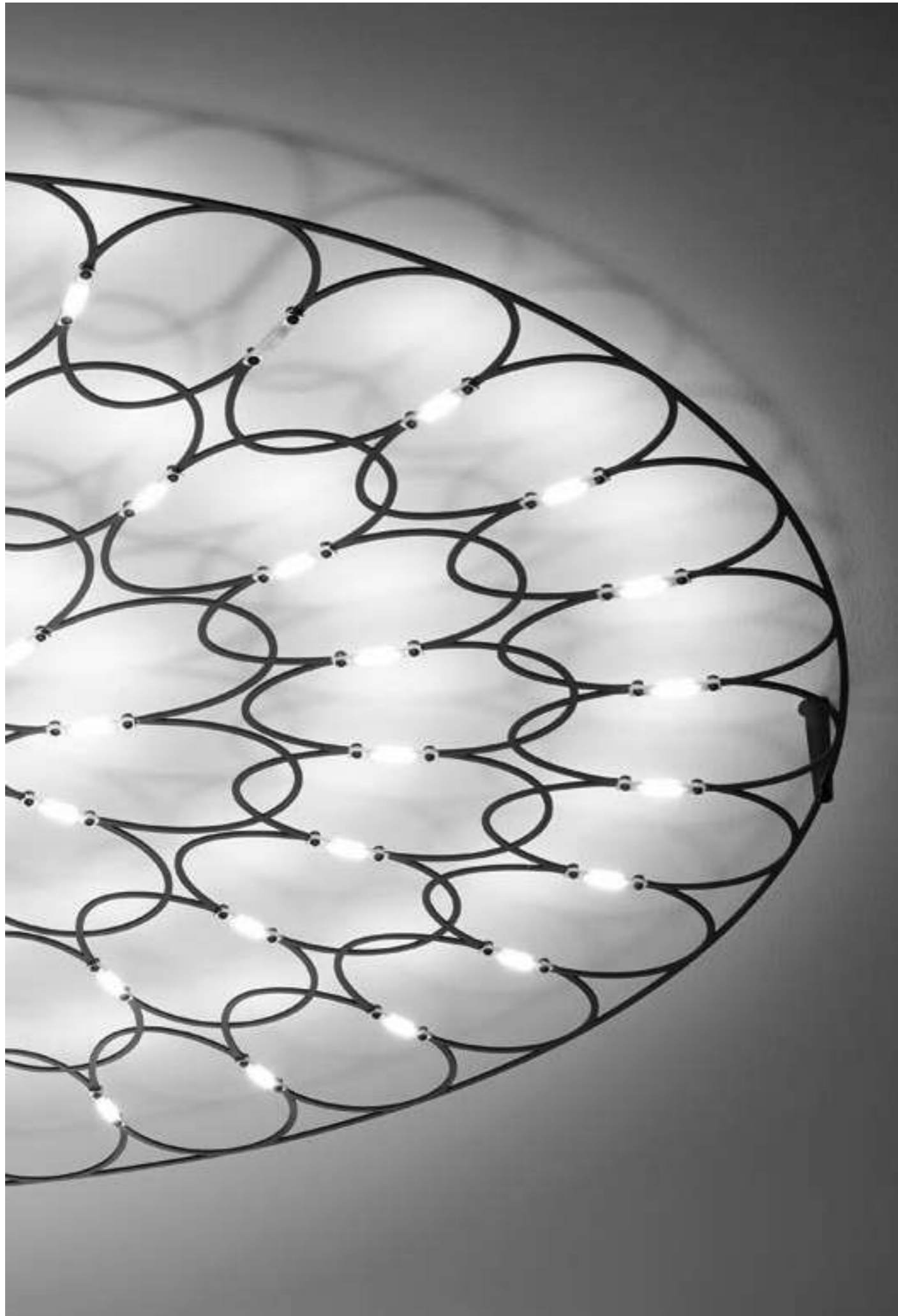

9W - 24V LED
2700°K / 735 lumen
3000°K / 817 lumen

Version:

On-Off

Push

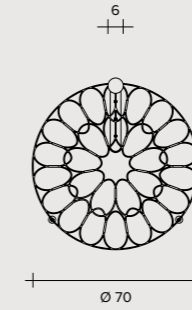

27W - 24V LED
2700°K / 2150 lumen
3000°K / 2389 lumen

Version:

On-Off

Push

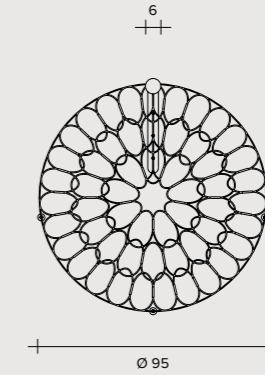

54W - 24V LED
2700°K / 4300 lumen
3000°K / 4778 lumen

Version:

On-Off

Push

LAFRA Ceiling lamp

Lampada da soffitto
Deckenleuchte
Lámpara de techo
Потолочный светильник



FINISHES / FINITURE / AUSFÜHRUNGEN / ACABADOS / ОТДЕЛКИ

● Chrome / Cromo / Chrom / Cromo / Хром

LAFRA 2.0 Ceiling lamp

Lampada da soffitto
Deckenleuchte
Lámpara de techo
Потолочный светильник



FINISHES / FINITURE / AUSFÜHRUNGEN / ACABADOS / ОТДЕЛКИ

● Black / Nero / Schwarz / Negro / Черный

LAFRA WALL





LAFRA WALL



LAFRA 2.0 WALL

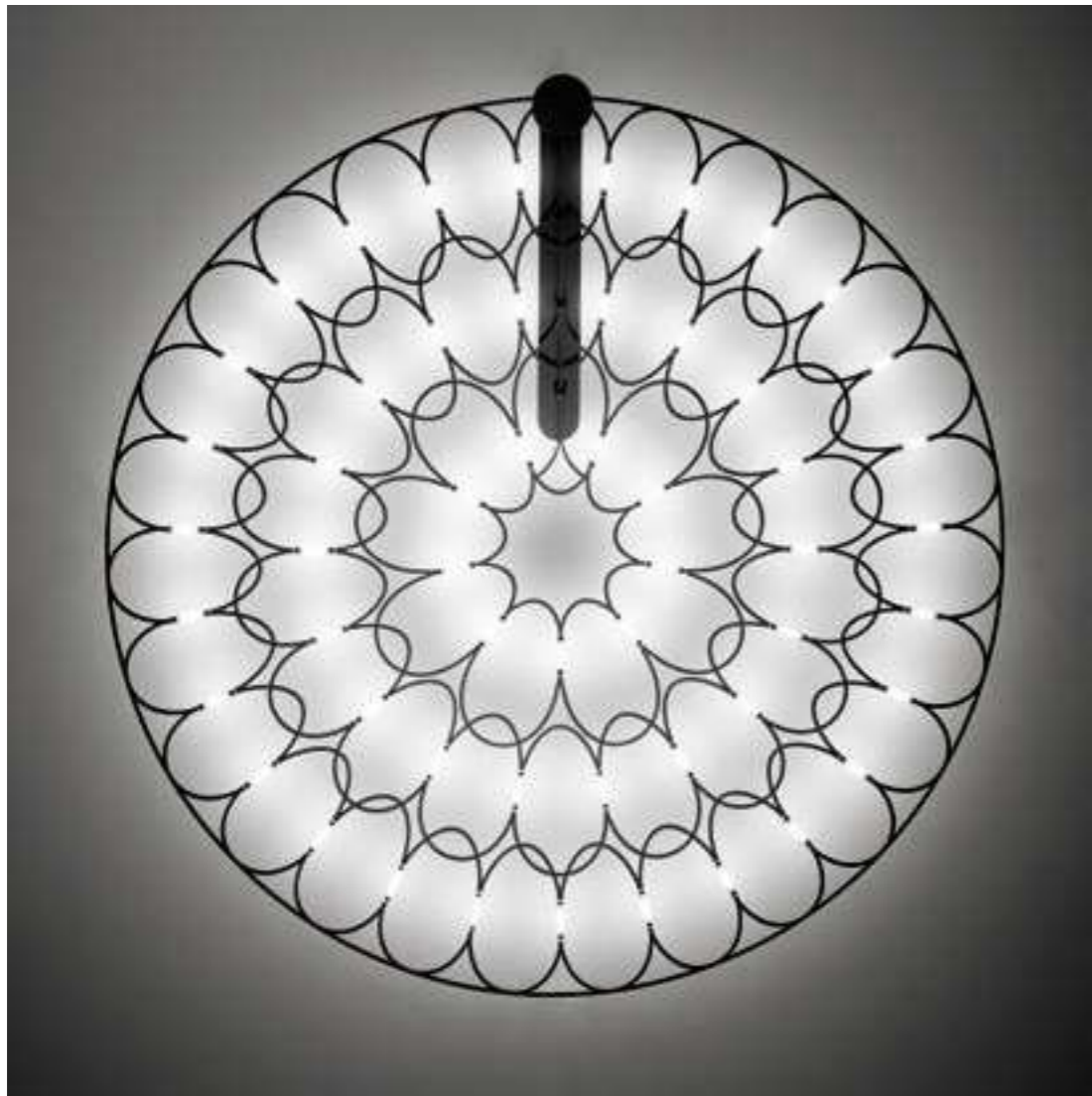

LAFRA 2.0 WALL

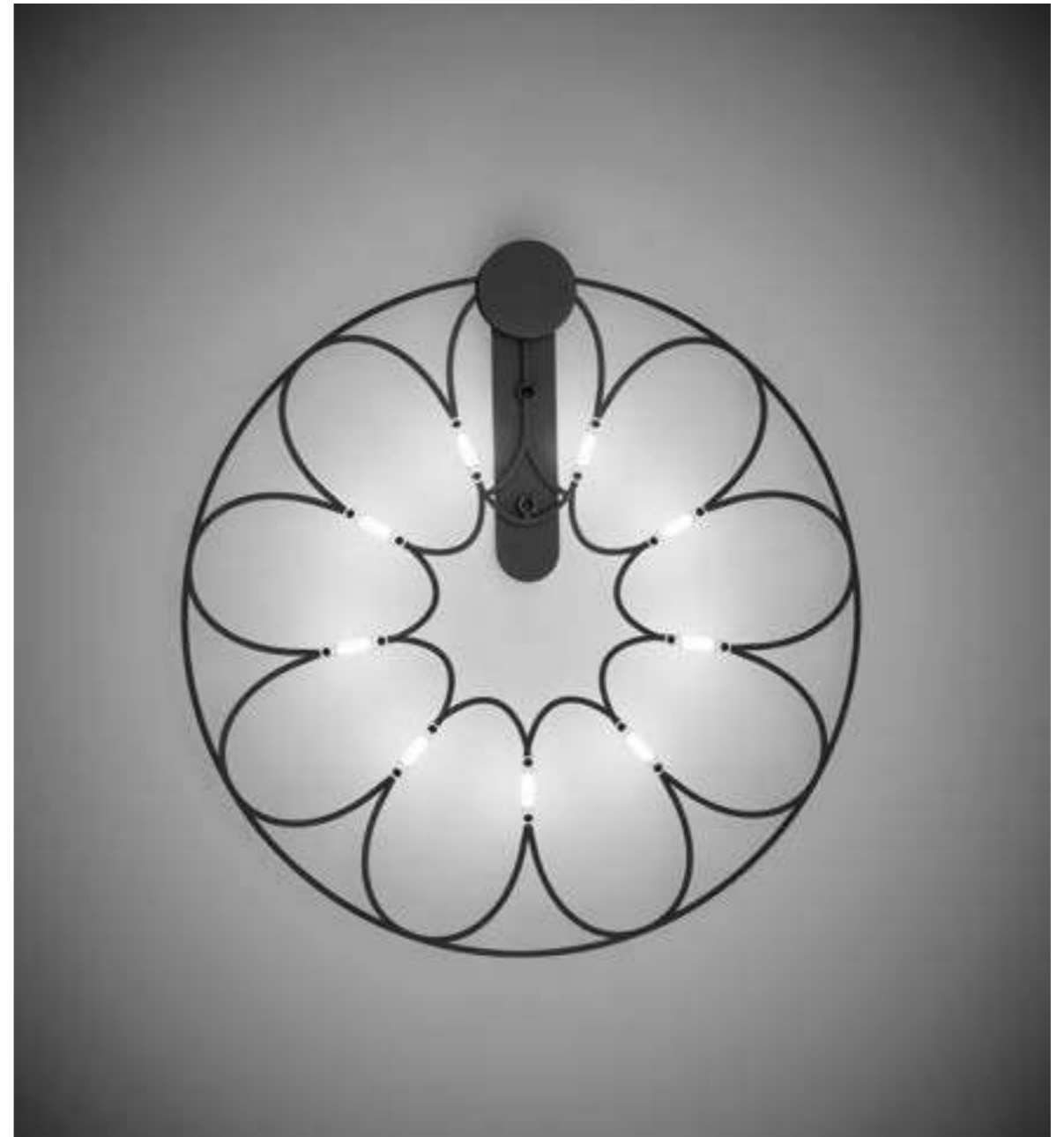
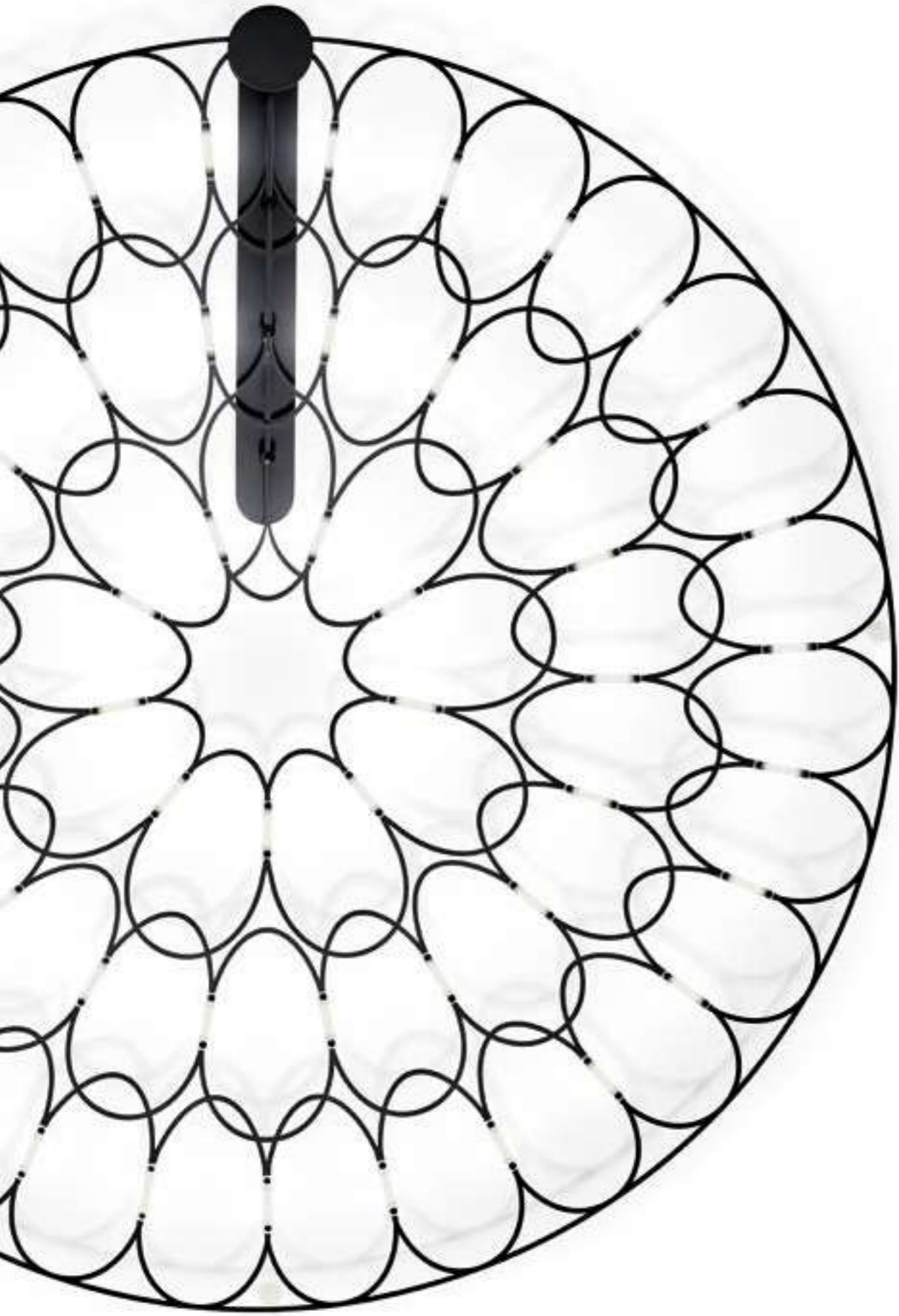



9W - 24V LED
2700°K / 735 lumen
3000°K / 817 lumen

Version:

On-Off

Push

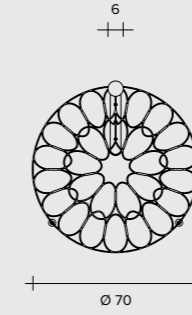

27W - 24V LED
2700°K / 2150 lumen
3000°K / 2389 lumen

Version:

On-Off

Push

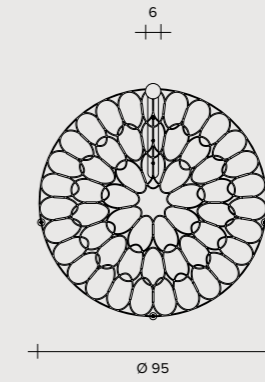

54W - 24V LED
2700°K / 4300 lumen
3000°K / 4778 lumen

Version:

On-Off

Push

LAFRA Wall lamp

Lampada da parete
Wandleuchte
Lámpara de pared
Настенный светильник



FINISHES / FINITURE / AUSFÜHRUNGEN / ACABADOS / ОТДЕЛКИ

● Chrome / Cromo / Chrom / Cromo / Хром

LAFRA 2.0 Wall lamp

Lampada da parete
Wandleuchte
Lámpara de pared
Настенный светильник



FINISHES / FINITURE / AUSFÜHRUNGEN / ACABADOS / ОТДЕЛКИ

● Black / Nero / Schwarz / Negro / Черный

BEBA

Urban Design Team

BEBA

An-almost alchemical vision. the series of pendant lamps with soft shapes represents a light borosilicate glass blow, which is pure poetry of light. Available with white off-centre kit or single drop-down ceiling canopy, in the same white colour. G9 connection.



BEBA

Quasi una visione alchemica, la serie di sospensioni dalle forme morbide rappresenta un soffio leggero in vetro borosilicato che è pura poesia della luce. Disponibile con kit di decentramento bianco o rosoni da calata unica, sempre bianchi. L'attacco è G9.

BEBA

Eine fast alchemistische Vision. Die Serie von Pendelleuchten mit weichen Formen stellt eine leichte Borosilikatglasblase dar, eine reine Poesie des Lichts. Erhältlich mit weißem dezentralen oder mit einfachem, abnehmbarem Deckenbaldachin in der gleichen weißen Farbe. G9-Anschluss.

BEBA

Casi una visión alquímica, la serie de lámparas colgantes de formas delicadas representa un soplo ligero en vidrio de borosilicato que es pura poesía de la luz. Disponible con kit de descentrado blanco o rosetones abatibles sencillos, también de color blanco. La conexión es G9.

BEBA

Серия подвесных светильников с мягкими формами, точно вышедших из алхимической лаборатории. Светильники, выполненные из невесомого дутого боросиликатного стекла, олицетворяют собой незамутненную поэзию света. Могут поставляться с белым комплектом для смещенного крепления или с белыми потолочными чашками с одним выводом. Цоколь G9.



BEBA SUSPENSION



BEBA SUSPENSION

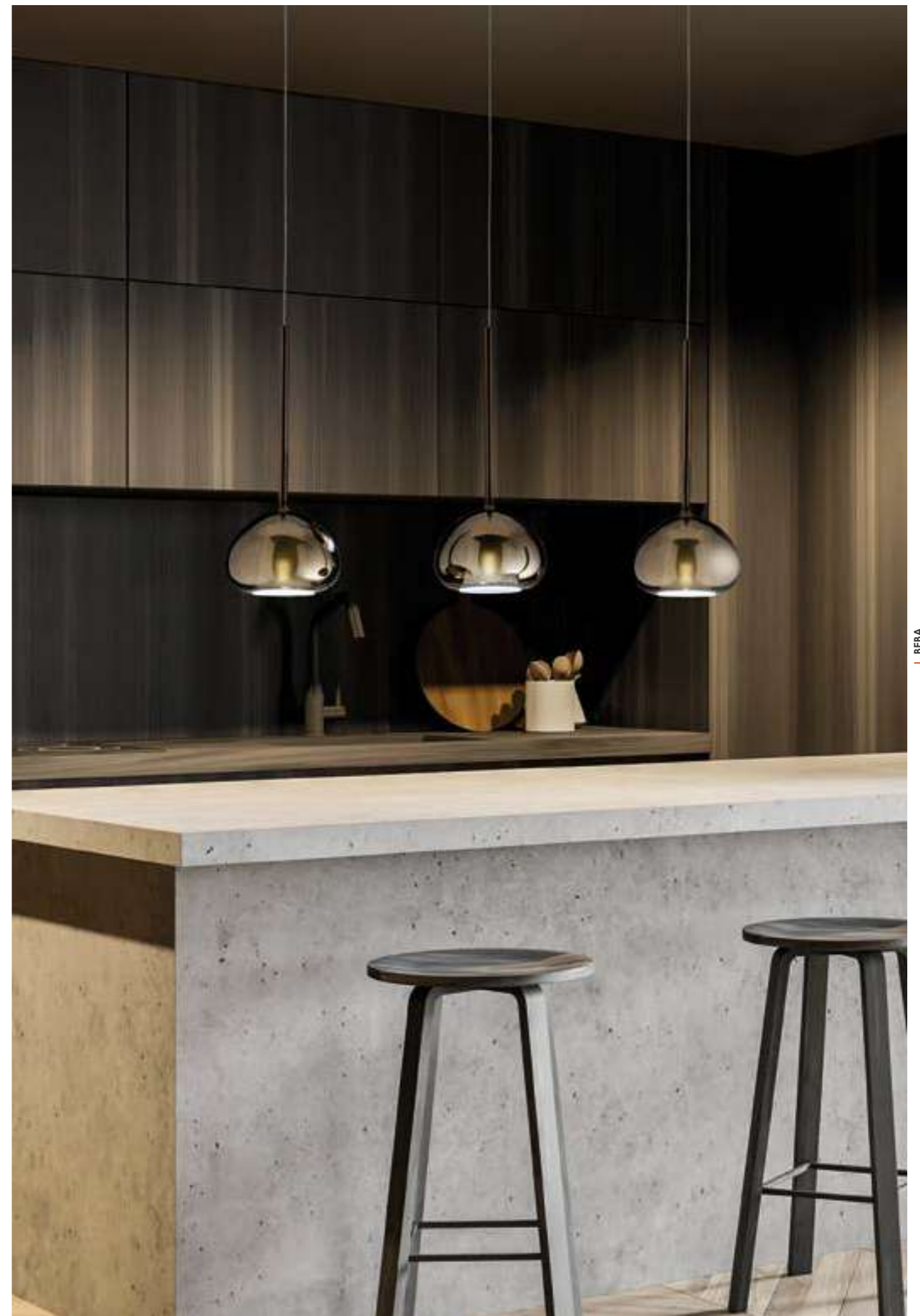



BEBA SUSPENSION





BEBA

SUSPENSION



BEBA SUSPENSION



BEBA SUSPENSION





BEBA SUSPENSION



BEBA SUSPENSION



1730.M.30



1730.M.34



1730.M.35



1730.M.36



1730.M.40



1730.M.41



1730.M.42

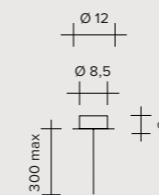

1xG9 max 28W - 230V

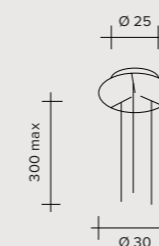

3xG9 max 28W - 230V

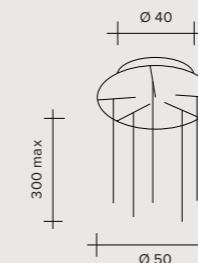

5xG9 max 28W - 230V

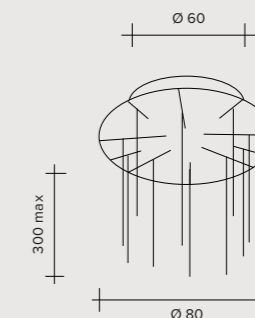

10x G9 max 28W - 230V

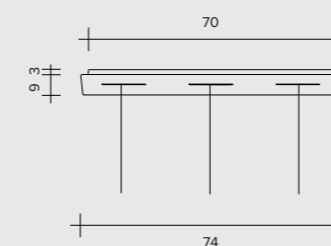

3xG9 max 28W - 230V

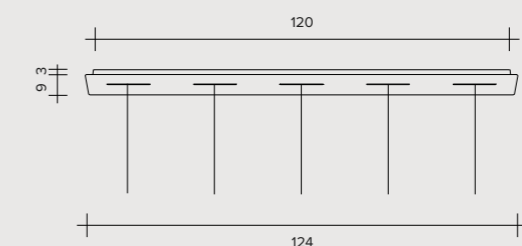

5xG9 max 28W - 230V



5xG9 max 28W - 230V

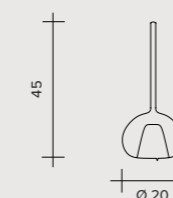
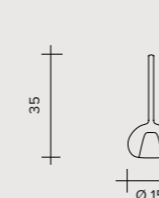

BEBA

Ceiling canopies for modular suspension lamps

Rosoni per composizioni lampade a sospensione

Baldachine für Pendelleuchtenkonfigurationen

Rosetones para composiciones de lámparas colgantes

Потолочные чашки для композиций из подвесных светильников



FINISHES / FINITURE / AUSFÜHRUNGEN / ACABADOS / ОТДЕЛКИ

GLASS

Vetro / Glas / Vidrio / Стекло

○ Trasparent / Trasparente / Transparent / Transparente / Прозрачный

● Chrome / Cromo / Chrom / Cromo / Хром

● Bronze / Bronzo / Bronze / Bronce / Бронза

● Gold / Oro / Gold / Oro / Золото

CEILING CANOPY

Rosone / Baldachin / Rosetón / Потолочные чашки

● Embossed white / Bianco gofrato

● Weiß gaufriert / Blanco gofrado / Гофрированный белый

PRICE LIST

LISTINO PREZZI

PREISLISTE

LISTA DE PRECIOS

ПРАЙС-ЛИСТ

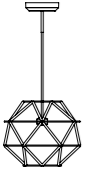
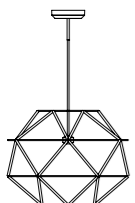
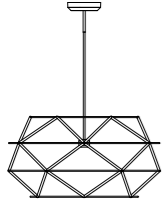
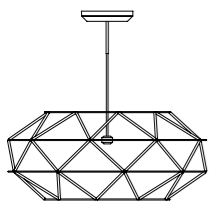
PRODUCT	FINISHES	°K	CODE	PAGE	PRICE € incl VAT (22%)	PRICE € excl VAT
 <p>EUCLIDE Suspension lamp 350</p>	Matt black Nero opaco Mattschwarz Negro mate Матовый черный	2700 °K	1821.30.2700	23	1.043,00	854,92
			1821.30.2700.DP***		1.078,00	883,61
		3000 °K	1821.30.3000		1.043,00	854,92
			1821.30.3000.DP***		1.078,00	883,61
	Gold Oro Gold Oro Золото	2700 °K	1822.30.2700	23	1.043,00	854,92
			1822.30.2700.DP***		1.078,00	883,61
		3000 °K	1822.30.3000		1.043,00	854,92
			1822.30.3000.DP***		1.078,00	883,61
 <p>EUCLIDE Suspension lamp 560</p>	Matt black Nero opaco Mattschwarz Negro mate Матовый черный	2700 °K	1821.31.2700	23	1.399,00	1.146,72
			1821.31.2700.D*		1.434,00	1.175,41
			1821.31.2700.DT**		1.434,00	1.175,41
		3000 °K	1821.31.3000		1.399,00	1.146,72
			1821.31.3000.D*		1.434,00	1.175,41
			1821.31.3000.DT**		1.434,00	1.175,41
	Gold Oro Gold Oro Золото	2700 °K	1822.31.2700	23	1.399,00	1.146,72
			1822.31.2700.D*		1.434,00	1.175,41
			1822.31.2700.DT**		1.434,00	1.175,41
		3000 °K	1822.31.3000		1.399,00	1.146,72
			1822.31.3000.D*		1.434,00	1.175,41
			1822.31.3000.DT**		1.434,00	1.175,41
 <p>EUCLIDE Suspension lamp 700</p>	Matt black Nero opaco Mattschwarz Negro mate Матовый черный	2700 °K	1821.32.2700	23	1.536,00	1.259,02
			1821.32.2700.D*		1.571,00	1.287,70
			1821.32.2700.DT**		1.571,00	1.287,70
		3000 °K	1821.32.3000		1.536,00	1.259,02
			1821.32.3000.D*		1.571,00	1.287,70
			1821.32.3000.DT**		1.571,00	1.287,70
	Gold Oro Gold Oro Золото	2700 °K	1822.32.2700	23	1.536,00	1.259,02
			1822.32.2700.D*		1.571,00	1.287,70
			1822.32.2700.DT**		1.571,00	1.287,70
		3000 °K	1822.32.3000		1.536,00	1.259,02
			1822.32.3000.D*		1.571,00	1.287,70
			1822.32.3000.DT**		1.571,00	1.287,70
 <p>EUCLIDE Suspension lamp 920</p>	Matt black Nero opaco Mattschwarz Negro mate Матовый черный	2700 °K	1821.33.2700	23	1.960,00	1.606,56
			1821.33.2700.D*		1.995,00	1.635,25
			1821.33.2700.DT**		1.995,00	1.635,25
		3000 °K	1821.33.3000		1.960,00	1.606,56
			1821.33.3000.D*		1.995,00	1.635,25
			1821.33.3000.DT**		1.995,00	1.635,25
	Gold Oro Gold Oro Золото	2700 °K	1822.33.2700	23	1.960,00	1.606,56
			1822.33.2700.D*		1.995,00	1.635,25
			1822.33.2700.DT**		1.995,00	1.635,25
		3000 °K	1822.33.3000		1.960,00	1.606,56
			1822.33.3000.D*		1.995,00	1.635,25
			1822.33.3000.DT**		1.995,00	1.635,25

* Dimmable with: Push 0-10V/1-10V/Dali / normally open button
Dimmerabile con: Push 0-10v / 1-10v/Dali / pulsante normalmente aperto
Dimmbar über: Push 0-10V / 1-10V/Dali / Taste normalerweise offen
Intensidad luminosa regulable con: Push 0-10v / 1-10v/Dali / botón normalmente abierto
Диммируется с помощью Push 0-10 В / 1-10 В /Dali / с нормально разомкнутой кнопкой

** Dimmable with: Triac
Dimmerabile con: Triac
Dimmbar über: Triac
Intensidad luminosa regulable con: Triac
Диммируется с помощью Triac

*** Dimmable with: Push
Dimmerabile con: Push
Dimmbar über: Push
Intensidad luminosa regulable con: Push
Диммируется с помощью Push

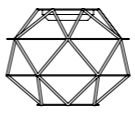
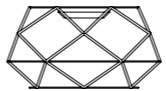
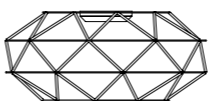

PRODUCT	FINISHES	°K	CODE	PAGE	PRICE € incl VAT (22%)	PRICE € excl VAT
 <p>EUCLIDE Ceiling lamp 350</p>	Matt black Nero opaco Mattschwarz Negro mate Матовый черный	2700 °K	1821.20.2700	33	1.043,00	854,92
			1821.20.2700.DP***		1.143,00	936,89
		3000 °K	1821.20.3000		1.043,00	854,92
			1821.20.3000.DP***		1.143,00	936,89
	Gold Oro Gold Oro Золото	2700 °K	1822.20.2700	33	1.043,00	854,92
			1822.20.2700.DP***		1.143,00	936,89
		3000 °K	1822.20.3000		1.043,00	854,92
			1822.20.3000.DP***		1.143,00	936,89
 <p>EUCLIDE Ceiling lamp 560</p>	Matt black Nero opaco Mattschwarz Negro mate Матовый черный	2700 °K	1821.21.2700	33	1.399,00	1.146,72
			1821.21.2700.D*		1.434,00	1.175,41
			1821.21.2700.DT**		1.434,00	1.175,41
		3000 °K	1821.21.3000		1.399,00	1.146,72
			1821.21.3000.D*		1.434,00	1.175,41
			1821.21.3000.DT**		1.434,00	1.175,41
	Gold Oro Gold Oro Золото	2700 °K	1822.21.2700	33	1.399,00	1.146,72
			1822.21.2700.D*		1.434,00	1.175,41
			1822.21.2700.DT**		1.434,00	1.175,41
		3000 °K	1822.21.3000		1.399,00	1.146,72
			1822.21.3000.D*		1.434,00	1.175,41
			1822.21.3000.DT**		1.434,00	1.175,41
 <p>EUCLIDE Ceiling lamp 700</p>	Matt black Nero opaco Mattschwarz Negro mate Матовый черный	2700 °K	1821.22.2700	33	1.536,00	1.259,02
			1821.22.2700.D*		1.571,00	1.287,70
			1821.22.2700.DT**		1.571,00	1.287,70
		3000 °K	1821.22.3000		1.536,00	1.259,02
			1821.22.3000.D*		1.571,00	1.287,70
			1821.22.3000.DT**		1.571,00	1.287,70
	Gold Oro Gold Oro Золото	2700 °K	1822.22.2700	33	1.536,00	1.259,02
			1822.22.2700.D*		1.571,00	1.287,70
			1822.22.2700.DT**		1.571,00	1.287,70
		3000 °K	1822.22.3000		1.536,00	1.259,02
			1822.22.3000.D*		1.571,00	1.287,70
			1822.22.3000.DT**		1.571,00	1.287,70
 <p>EUCLIDE Ceiling lamp 920</p>	Matt black Nero opaco Mattschwarz Negro mate Матовый черный	2700 °K	1821.23.2700	33	1.960,00	1.606,56
			1821.23.2700.D*		1.995,00	1.635,25
			1821.23.2700.DT**		1.995,00	1.635,25
		3000 °K	1821.23.3000		1.960,00	1.606,56
			1821.23.3000.D*		1.995,00	1.635,25
			1821.23.3000.DT**		1.995,00	1.635,25
	Gold Oro Gold Oro Золото	2700 °K	1822.23.2700	33	1.960,00	1.606,56
			1822.23.2700.D*		1.995,00	1.635,25
			1822.23.2700.DT**		1.995,00	1.635,25
		3000 °K	1822.23.3000		1.960,00	1.606,56
			1822.23.3000.D*		1.995,00	1.635,25
			1822.23.3000.DT**		1.995,00	1.635,25

* Dimmable with: Push 0-10V/1-10V/Dali / normally open button
Dimmerabile con: Push 0-10v / 1-10v/Dali / pulsante normalmente aperto
Dimmbar über: Push 0-10V / 1-10V/Dali / Taste normalerweise offen
Intensidad luminosa regulable con: Push 0-10v / 1-10v/Dali / botón normalmente abierto
Диммируется с помощью Push 0-10 В / 1-10 В /Dali / с нормально разомкнутой кнопкой

** Dimmable with: Triac
Dimmerabile con: Triac
Dimmbar über: Triac
Intensidad luminosa regulable con: Triac
Диммируется с помощью Triac



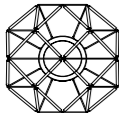

*** Dimmable with: Push
Dimmerabile con: Push
Dimmbar über: Push
Intensidad luminosa regulable con: Push
Диммируется с помощью Push

PRICE LIST_EUCLIDE

PRODUCT	FINISHES	°K	CODE	PAGE	PRICE € incl VAT (22%)	PRICE € excl VAT
 EUCLIDE Wall	Matt black <i>Nero opaco</i> Mattschwarz Negro mate Матовый черный	2700 °K	1821.10.2700	39	732,00	600,00
		3000 °K	1821.10.3000		732,00	600,00
	Gold <i>Oro</i> Gold Oro Золото	2700 °K	1822.10.2700	39	732,00	600,00
		3000 °K	1822.10.3000		732,00	600,00
 EUCLIDE Floor	Matt black <i>Nero opaco</i> Mattschwarz Negro mate Матовый черный	2700 °K	1821.50.2700.D***	43	1.650,00	1.352,46
		3000 °K	1821.50.3000.D***		1.650,00	1.352,46
	Gold <i>Oro</i> Gold Oro Золото	2700 °K	1822.50.2700.D***	43	1.650,00	1.352,46
		3000 °K	1822.50.3000.D***		1.650,00	1.352,46



*** Footswitch dimmer included.
 Dimmer a pedale incluso.
 Inklusive Fußdimmer.
 Regulador de intensidad con pedal incluido.
 В комплект входит диммер с ножным управлением.

PRICE LIST_FILO

PRODUCT	FINISHES	°K	CODE	PAGE	PRICE € incl VAT (22%)	PRICE € excl VAT
 FILO Suspension Ø 50	Matt powder pink <i>Cipria opaco</i> Puderrosa matt Rosa palo mate Пудровый матовый	2700 °K	1839.30.2700	57	1.703,00	1.395,90
			1839.30.2700.D*		1.803,00	1.477,87
	Titanium <i>Titanio</i> Titan Titanio Титан	2700 °K	1840.30.2700	57	1.703,00	1.395,90
		3000 °K	1840.30.3000		1.803,00	1.477,87
 FILO Suspension Ø 70	Matt powder pink <i>Cipria opaco</i> Puderrosa matt Rosa palo mate Пудровый матовый	2700 °K	1839.31.2700	57	2.057,00	1.686,07
			1839.31.2700.D*		2.157,00	1.768,03
	Titanium <i>Titanio</i> Titan Titanio Титан	2700 °K	1840.31.2700	57	2.057,00	1.686,07
		3000 °K	1840.31.3000		2.157,00	1.768,03
 FILO Suspension Ø 90	Matt powder pink <i>Cipria opaco</i> Puderrosa matt Rosa palo mate Пудровый матовый	2700 °K	1839.32.2700	57	2.486,00	2.037,70
			1839.32.2700.D*		2.586,00	2.119,67
	Titanium <i>Titanio</i> Titan Titanio Титан	2700 °K	1840.32.2700	57	2.486,00	2.037,70
		3000 °K	1840.32.3000		2.586,00	2.119,67
 FILO Suspension Ø 110	Matt powder pink <i>Cipria opaco</i> Puderrosa matt Rosa palo mate Пудровый матовый	2700 °K	1839.33.2700	57	3.077,00	2.522,13
			1839.33.2700.D*		3.177,00	2.604,10
	Titanium <i>Titanio</i> Titan Titanio Титан	2700 °K	1840.33.2700	57	3.077,00	2.522,13
		3000 °K	1840.33.3000		3.177,00	2.604,10

* Dimmable with: Push 0-10V/1-10V/Dali / normally open button
 Dimmerabile con: Push 0-10v / 1-10v/Dali / pulsante normalmente aperto
 Dimmbar über: Push 0-10V / 1-10V/Dali / Taste normalerweise offen
 Intensidad luminosa regulable con: Push 0-10v / 1-10v/Dali / botón normalmente abierto
 Диммируется с помощью Push 0-10 В / 1-10 В/Dali / с нормально разомкнутой кнопкой

** Dimmable with: Triac
 Dimmerabile con: Triac
 Dimmbar über: Triac
 Intensidad luminosa regulable con: Triac
 Диммируется с помощью Triac

PRODUCT	FINISHES	°K	CODE	PAGE	PRICE € incl VAT (22%)	PRICE € excl VAT
 <p>FILO Ceiling lamp Ø 50</p>	Matt powder pink <i>Cipria opaco</i> <i>Puderrosa matt</i> <i>Rosa palo mate</i> Пудровый матовый	2700 °K	1839.20.2700	65	1.674,00	1.372,13
			1839.20.2700.D*		1.774,00	1.454,10
			1839.20.2700.DT**		1.774,00	1.454,10
		3000 °K	1839.20.3000		1.674,00	1.372,13
			1839.20.3000.D*		1.774,00	1.454,10
			1839.20.3000.DT**		1.774,00	1.454,10
	Titanium <i>Titanio</i> <i>Titan</i> <i>Titanio</i> Титан	2700 °K	1840.20.2700	65	1.674,00	1.372,13
			1840.20.2700.D*		1.774,00	1.454,10
			1840.20.2700.DT**		1.774,00	1.454,10
		3000 °K	1840.20.3000		1.674,00	1.372,13
			1840.20.3000.D*		1.774,00	1.454,10
			1840.20.3000.DT**		1.774,00	1.454,10
 <p>FILO Ceiling lamp Ø 80</p>	Matt powder pink <i>Cipria opaco</i> <i>Puderrosa matt</i> <i>Rosa palo mate</i> Пудровый матовый	2700 °K	1839.21.2700	65	1.731,00	1.418,85
			1839.21.2700.D*		1.831,00	1.500,82
			1839.21.2700.DT**		1.831,00	1.500,82
		3000 °K	1839.21.3000		1.731,00	1.418,85
			1839.21.3000.D*		1.831,00	1.500,82
			1839.21.3000.DT**		1.831,00	1.500,82
	Titanium <i>Titanio</i> <i>Titan</i> <i>Titanio</i> Титан	2700 °K	1840.21.2700	65	1.731,00	1.418,85
			1840.21.2700.D*		1.831,00	1.500,82
			1840.21.2700.DT**		1.831,00	1.500,82
		3000 °K	1840.21.3000		1.731,00	1.418,85
			1840.21.3000.D*		1.831,00	1.500,82
			1840.21.3000.DT**		1.831,00	1.500,82
 <p>FILO Ceiling lamp Ø 100</p>	Matt powder pink <i>Cipria opaco</i> <i>Puderrosa matt</i> <i>Rosa palo mate</i> Пудровый матовый	2700 °K	1839.22.2700	65	2.127,00	1.743,44
			1839.22.2700.D*		2.227,00	1.825,41
			1839.22.2700.DT**		2.227,00	1.825,41
		3000 °K	1839.22.3000		2.127,00	1.743,44
			1839.22.3000.D*		2.227,00	1.825,41
			1839.22.3000.DT**		2.227,00	1.825,41
	Titanium <i>Titanio</i> <i>Titan</i> <i>Titanio</i> Титан	2700 °K	1840.22.2700	65	2.127,00	1.743,44
			1840.22.2700.D*		2.227,00	1.825,41
			1840.22.2700.DT**		2.227,00	1.825,41
		3000 °K	1840.22.3000		2.127,00	1.743,44
			1840.22.3000.D*		2.227,00	1.825,41
			1840.22.3000.DT**		2.227,00	1.825,41

* Dimmable with: Push 0-10V/1-10V/Dali / normally open button
 Dimmerabile con: Push 0-10v / 1-10v/Dali / pulsante normalmente aperto
 Dimmbar über: Push 0-10V / 1-10V/Dali / Taste normalerweise offen
 Intensidad luminosa regulable con: Push 0-10v / 1-10v/Dali / botón normalmente abierto
 Диммируется с помощью Push 0-10 В / 1-10 В/Dali / с нормально разомкнутой кнопкой

** Dimmable with: Triac
 Dimmerabile con: Triac
 Dimmbar über: Triac
 Intensidad luminosa regulable con: Triac
 Диммируется с помощью Triac

Surface mounting - Suspension

Luminaire / Corpo illuminante / Beleuchtungskörper / Luminaria / Светильник

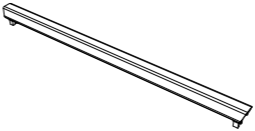

PRODUCT	FINISHES	CM.	W	°K	LUMEN	CODE	PAGE	PRICE € incl VAT (22%)	PRICE € excl VAT		
 <p>CARTESIAN Surface Mounting</p>	Light module <i>Modulo luce</i> <i>Lichtmodul</i> <i>Módulo de luz</i> Световой модуль 24V - CRI 90	30	5W	2700 °K	400	1832.2.2700	78	49,00	40,16		
				3000 °K	500	1832.2.3000	78	49,00	40,16		
				60	10W	2700 °K	800	1832.3.2700	78	59,00	48,36
						3000 °K	1000	1832.3.3000	78	59,00	48,36
				90	15W	2700 °K	1200	1832.4.2700	78	69,00	56,56
						3000 °K	1500	1832.4.3000	78	69,00	56,56
		120	20W	2700 °K	1600	1832.5.2700	78	79,00	64,75		
				3000 °K	2000	1832.5.3000	78	79,00	64,75		

Accessories

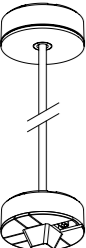
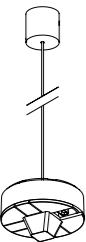
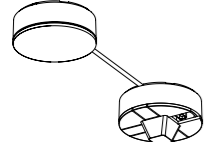
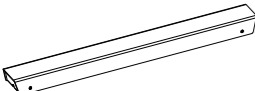
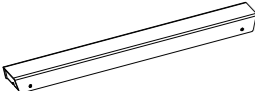
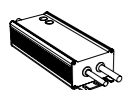
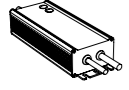
Ceiling canopies and driver / Driver e rosone / Baldachine und Driver / Rosetones y controladores / Потолочные чашки и драйверы

ACCESSORIES	W	CODE	PRICE € incl VAT (22%)	PRICE € excl VAT
 Cartesian system connection base <i>Basetta di collegamento per sistema Cartesian</i> <i>Anschlusssockel für das System Cartesian</i> <i>Placa de conexión para sistema cartesiano</i> <i>Основание для подключения для системы Cartesian</i>		1832.1	39,00	31,97
 Ceiling canopy with power supply cable <i>Rosone soffitto con cavo di alimentazione</i> <i>Deckenbaldachin mit Stromkabel</i> <i>Rosetón de techo con cable de alimentación</i> <i>Потолочная чашка с проводом</i>		1832.12	105,00	86,07
 Steel ceiling cable kit <i>Kit cavo acciaio soffitto</i> <i>Deckenkabel-Set aus Stahl</i> <i>Kit cable de acero para techo</i> <i>Комплект потолочного крепежа из стали</i>		1832.13	79,00	64,75
 Remote driver ceiling canopy <i>Rosone driver remoto</i> <i>Baldachin ferngesteuerter Driver</i> <i>Rosetón controlador remoto</i> <i>Потолочная чашка с выносным драйвером</i>		1832.14	49,00	40,16
	60W	1832.6	178,00	145,90
	100W	1832.7	220,00	180,33
	200W	1832.8	308,00	252,46
	60W Dimmer	1832.9	302,00	247,54
	100W Dimmer	1832.10	345,00	282,79
	200W Dimmer	1832.11	433,00	354,92
	50W	T73.50W.24.SNP	58,00	47,54
	100W	T73.100W.24.SNP	108,00	88,52
	150W	T73.150W.24.SNP	102,00	83,61
	200W	T73.200W.24.SNP	163,00	133,61
	320W	T73.320W.24.SNP	237,00	194,26
	40W DIMMABLE	T73.40W.24.DIM	97,00	79,51
	100W DIMMABLE	T73.100W.24.DIM	146,00	119,67
	150W DIMMABLE	T73.150W.24.DIM	153,00	125,41
	200W DIMMABLE	T73.200W.24.DIM	192,00	157,38
	320W DIMMABLE	T73.320W.24.DIM	261,00	213,93

PRODUCT	FINISHES	°K	CODE	PAGE	PRICE € incl VAT (22%)	PRICE € excl VAT
	Dove grey <i>Tortora</i> <i>Taubengrau</i> <i>Gris paloma</i> <i>Тайн</i>	3000 °K	1828.20	95	313,00	256,56
	Dark grey <i>Grigio scuro</i> <i>Dunkelgrau</i> <i>Gris oscuro</i> <i>Темно-серый</i>	3000 °K	1829.20	95	313,00	256,56
	White <i>Bianco</i> <i>Weiß</i> <i>Blanco</i> <i>Белый</i>	3000 °K	1830.20	95	313,00	256,56
	Dove grey <i>Tortora</i> <i>Taubengrau</i> <i>Gris paloma</i> <i>Тайн</i>	3000 °K	1828.21	95	439,00	359,84
	Dark grey <i>Grigio scuro</i> <i>Dunkelgrau</i> <i>Gris oscuro</i> <i>Темно-серый</i>	3000 °K	1829.21	95	439,00	359,84
	White <i>Bianco</i> <i>Weiß</i> <i>Blanco</i> <i>Белый</i>	3000 °K	1830.21	95	439,00	359,84
	Dove grey <i>Tortora</i> <i>Taubengrau</i> <i>Gris paloma</i> <i>Тайн</i>	3000 °K	1828.22	95	632,00	518,03
	Dark grey <i>Grigio scuro</i> <i>Dunkelgrau</i> <i>Gris oscuro</i> <i>Темно-серый</i>	3000 °K	1829.22	95	632,00	518,03
	White <i>Bianco</i> <i>Weiß</i> <i>Blanco</i> <i>Белый</i>	3000 °K	1830.22	95	632,00	518,03

PRODUCT	FINISHES	°K	CODE	PAGE	PRICE € incl VAT (22%)	PRICE € excl VAT
 <p>ANELLO Suspension lamp Ø 55</p>	Painted black <i>Nero verniciato</i> <i>Schwarz lackiert</i> <i>Negro pintado</i> <i>Окрашено в Черный</i>	2700 °K	1790.30.2700	121	693,00	568,03
			1790.30.2700.D*		793,00	650,00
		3000 °K	1790.30.3000		693,00	568,03
			1790.30.3000.D*		793,00	650,00
	Brushed bronze <i>Bronzo spazzolato</i> <i>Bronze gebürstet</i> <i>Bronce cepillado</i> <i>Брашированная бронза</i>	2700 °K	1799.30.2700	121	693,00	568,03
			1799.30.2700.D*		793,00	650,00
		3000 °K	1799.30.3000		693,00	568,03
			1799.30.3000.D*		793,00	650,00
	Brushed gold <i>Oro spazzolato</i> <i>Gold gebürstet</i> <i>Oro cepillado</i> <i>Брашированное золото</i>	2700 °K	1800.30.2700	121	693,00	568,03
			1800.30.2700.D*		793,00	650,00
		3000 °K	1800.30.3000		693,00	568,03
			1800.30.3000.D*		793,00	650,00
Brushed copper <i>Rame spazzolato</i> <i>Kupfer gebürstet</i> <i>Cobre cepillado</i> <i>Крацованная медь</i>	2700 °K	1801.30.2700	121	693,00	568,03	
		1801.30.2700.D*		793,00	650,00	
	3000 °K	1801.30.3000		693,00	568,03	
		1801.30.3000.D*		793,00	650,00	
 <p>ANELLO Suspension lamp Ø 78</p>	Painted black <i>Nero verniciato</i> <i>Schwarz lackiert</i> <i>Negro pintado</i> <i>Окрашено в Черный</i>	2700 °K	1790.31.2700	121	852,00	698,36
			1790.31.2700.D*		952,00	780,33
			1790.31.2700.DT**		952,00	780,33
		3000 °K	1790.31.3000		852,00	698,36
			1790.31.3000.D*		952,00	780,33
			1790.31.3000.DT**		952,00	780,33
	Brushed bronze <i>Bronzo spazzolato</i> <i>Bronze gebürstet</i> <i>Bronce cepillado</i> <i>Брашированная бронза</i>	2700 °K	1799.31.2700	121	852,00	698,36
			1799.31.2700.D*		952,00	780,33
			1799.31.2700.DT**		952,00	780,33
		3000 °K	1799.31.3000		852,00	698,36
			1799.31.3000.D*		952,00	780,33
			1799.31.3000.DT**		952,00	780,33
	Brushed gold <i>Oro spazzolato</i> <i>Gold gebürstet</i> <i>Oro cepillado</i> <i>Брашированное золото</i>	2700 °K	1800.31.2700	121	852,00	698,36
			1800.31.2700.D*		952,00	780,33
			1800.31.2700.DT**		952,00	780,33
		3000 °K	1800.31.3000		852,00	698,36
			1800.31.3000.D*		952,00	780,33
			1800.31.3000.DT**		952,00	780,33
	Brushed copper <i>Rame spazzolato</i> <i>Kupfer gebürstet</i> <i>Cobre cepillado</i> <i>Крацованная медь</i>	2700 °K	1801.31.2700	121	852,00	698,36
			1801.31.2700.D*		952,00	780,33
			1801.31.2700.DT**		952,00	780,33
		3000 °K	1801.31.3000		852,00	698,36
			1801.31.3000.D*		952,00	780,33
			1801.31.3000.DT**		952,00	780,33

* Dimmable with: Push 0-10V/1-10V/Dali / normally open button
 Dimmerabile con: Push 0-10v / 1-10v/Dali / pulsante normalmente aperto
 Dimmbar über: Push 0-10V / 1-10V/Dali / Taste normalerweise offen
 Intensidad luminosa regulable con: Push 0-10v / 1-10v/Dali / botón normalmente abierto
 Диммируется с помощью Push 0-10 В / 1-10 В/Dali / с нормально разомкнутой кнопкой

** Dimmable with: Triac
 Dimmerabile con: Triac
 Dimmbar über: Triac
 Intensidad luminosa regulable con: Triac
 Диммируется с помощью Triac

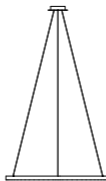
PRODUCT	FINISHES	°K	CODE	PAGE	PRICE € incl VAT (22%)	PRICE € excl VAT
 <p>ANELLO Suspension lamp Ø 109</p>	Painted black <i>Nero verniciato</i> <i>Schwarz lackiert</i> <i>Negro pintado</i> <i>Окрашено в Черный</i>	2700 °K	1790.32.2700	121	1.028,00	842,62
			1790.32.2700.D*		1.128,00	924,59
			1790.32.2700.DT**		1.128,00	924,59
		3000 °K	1790.32.3000		1.028,00	842,62
			1790.32.3000.D*		1.128,00	924,59
			1790.32.3000.DT**		1.128,00	924,59
	Brushed bronze <i>Bronzo spazzolato</i> <i>Bronze gebürstet</i> <i>Bronce cepillado</i> <i>Брашированная бронза</i>	2700 °K	1799.32.2700	121	1.028,00	842,62
			1799.32.2700.D*		1.128,00	924,59
			1799.32.2700.DT**		1.128,00	924,59
		3000 °K	1799.32.3000		1.028,00	842,62
			1799.32.3000.D*		1.128,00	924,59
			1799.32.3000.DT**		1.128,00	924,59
	Brushed gold <i>Oro spazzolato</i> <i>Gold gebürstet</i> <i>Oro cepillado</i> <i>Брашированное золото</i>	2700 °K	1800.32.2700	121	1.028,00	842,62
			1800.32.2700.D*		1.128,00	924,59
			1800.32.2700.DT**		1.128,00	924,59
		3000 °K	1800.32.3000		1.028,00	842,62
			1800.32.3000.D*		1.128,00	924,59
			1800.32.3000.DT**		1.128,00	924,59
	Brushed copper <i>Rame spazzolato</i> <i>Kupfer gebürstet</i> <i>Cobre cepillado</i> <i>Крацованная медь</i>	2700 °K	1801.32.2700	121	1.028,00	842,62
			1801.32.2700.D*		1.128,00	924,59
			1801.32.2700.DT**		1.128,00	924,59
		3000 °K	1801.32.3000		1.028,00	842,62
			1801.32.3000.D*		1.128,00	924,59
			1801.32.3000.DT**		1.128,00	924,59

* Dimmable with: Push 0-10V/1-10V/Dali / normally open button
 Dimmerabile con: Push 0-10v / 1-10v/Dali / pulsante normalmente aperto
 Dimmbar über: Push 0-10V / 1-10V/Dali / Taste normalerweise offen
 Intensidad luminosa regulable con: Push 0-10v / 1-10v/Dali / botón normalmente abierto
 Диммируется с помощью Push 0-10 В / 1-10 В/Dali / с нормально разомкнутой кнопкой

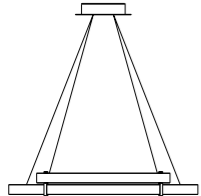

** Dimmable with: Triac
 Dimmerabile con: Triac
 Dimmbar über: Triac
 Intensidad luminosa regulable con: Triac
 Диммируется с помощью Triac

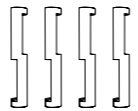
PRODUCT	FINISHES	°K	CODE	PAGE	PRICE € incl VAT (22%)	PRICE € excl VAT
 <p>ANELLO Double suspension lamp (Rings only joint kit not included)</p> <p>Rings only, joint kit not included. <i>Solo anelli. Joint Kit non incluso. Nur Ringe, Joint Kit nicht inbegriffen. Solo anillos, kit de junta no incluido. Только кольца, соединительный комплект не входит в поставку.</i></p>	Painted black <i>Nero verniciato Schwarz lackiert Negro pintado Окрашено в Черный</i>	2700 °K	1790.33.2700	131	1.546,00	1.267,21
			1790.33.2700.D*		1.646,00	1.349,18
			1790.33.2700.DT**		1.646,00	1.349,18
		3000 °K	1790.33.3000		1.546,00	1.267,21
			1790.33.3000.D*		1.646,00	1.349,18
			1790.33.3000.DT**		1.646,00	1.349,18
	Brushed bronze <i>Bronzo spazzolato Bronze gebürstet Bronce cepillado Брашированная бронза</i>	2700 °K	1799.33.2700	131	1.546,00	1.267,21
			1799.33.2700.D*		1.646,00	1.349,18
			1799.33.2700.DT**		1.646,00	1.349,18
		3000 °K	1799.33.3000		1.546,00	1.267,21
			1799.33.3000.D*		1.646,00	1.349,18
			1799.33.3000.DT**		1.646,00	1.349,18
	Brushed gold <i>Oro spazzolato Gold gebürstet Oro cepillado Брашированное золото</i>	2700 °K	1800.33.2700	131	1.546,00	1.267,21
			1800.33.2700.D*		1.646,00	1.349,18
			1800.33.2700.DT**		1.646,00	1.349,18
		3000 °K	1800.33.3000		1.546,00	1.267,21
			1800.33.3000.D*		1.646,00	1.349,18
			1800.33.3000.DT**		1.646,00	1.349,18
Brushed copper <i>Rame spazzolato Kupfer gebürstet Cobre cepillado Крацованная медь</i>	2700 °K	1801.33.2700	131	1.546,00	1.267,21	
		1801.33.2700.D*		1.646,00	1.349,18	
		1801.33.2700.DT**		1.646,00	1.349,18	
	3000 °K	1801.33.3000		1.546,00	1.267,21	
		1801.33.3000.D*		1.646,00	1.349,18	
		1801.33.3000.DT**		1.646,00	1.349,18	

PRODUCT	FINISHES	°K	CODE	PAGE	PRICE € incl VAT (22%)	PRICE € excl VAT											
 <p>JOINT KIT Double suspension lamp</p>	Set of two clasps for Black Anello series suspension lamp. Set due ganci per sospensione serie Anello colore Nero . Satz mit zwei Haken für die Aufhängung Serie Anello Farbe Schwarz . Juego de dos ganchos para elemento de suspensión serie Anello color negro . Комплект из двух зажимов для Подвесного элемента серии Anello цвет Черный .	1825.BLACK	131	66,00	54,10												
						Set of two clasps for Gold Anello series suspension lamp. Set due ganci per sospensione serie Anello colore Oro . Satz mit zwei Haken für die Aufhängung Serie Anello Farbe Gold . Juego de dos ganchos para elemento de suspensión serie Anello color oro . Комплект из двух зажимов для Подвесного элемента серии Anello цвет Золото .	1825.GOLD	66,00	54,10								
										Set of two clasps for Copper Anello series suspension lamp. Set due ganci per sospensione serie Anello colore Rame . Satz mit zwei Haken für die Aufhängung Serie Anello Farbe Kupfer . Juego de dos ganchos para elemento de suspensión serie Anello color cobre . Комплект из двух зажимов для Подвесного элемента серии Anello цвет Медь .	1825.COPPER	66,00	54,10				
														Set of two clasps for Aluminium Anello series suspension lamp. Set due ganci per sospensione serie Anello colore Alluminio . Satz mit zwei Haken für die Aufhängung Serie Anello Farbe Aluminium . Juego de dos ganchos para elemento de suspensión serie Anello color aluminio . Комплект из двух зажимов для Подвесного элемента серии Anello цвет Алюминий .	1825.ALLUM	66,00	54,10

* Dimmable with: Push 0-10V/1-10V/Dali / normally open button
Dimmerabile con: Push 0-10v / 1-10v/Dali / pulsante normalmente aperto
Dimmbar über: Push 0-10V / 1-10V/Dali / Taste normalerweise offen
Intensidad luminosa regulable con: Push 0-10v / 1-10v/Dali / botón normalmente abierto
Диммируется с помощью Push 0-10 В / 1-10 В/Dali / с нормально разомкнутой кнопкой

** Dimmable with: Triac
Dimmerabile con: Triac
Dimmbar über: Triac
Intensidad luminosa regulable con: Triac
Диммируется с помощью Triac

PRODUCT	FINISHES	°K	CODE	PAGE	PRICE € incl VAT (22%)	PRICE € excl VAT
 <p>ANELLO Ceiling lamp Ø 55</p>	Painted black <i>Nero verniciato</i> <i>Schwarz lackiert</i> <i>Negro pintado</i> <i>Окрашено в Черный</i>	2700 °K	1790.20.2700	109	858,00	703,28
			1790.20.2700.D*		958,00	785,25
		3000 °K	1790.20.3000		858,00	703,28
			1790.20.3000.D*		958,00	785,25
	Brushed bronze <i>Bronzo spazzolato</i> <i>Bronze gebürstet</i> <i>Bronce cepillado</i> <i>Брашированная бронза</i>	2700 °K	1799.20.2700	109	858,00	703,28
			1799.20.2700.D*		958,00	785,25
		3000 °K	1799.20.3000		858,00	703,28
			1799.20.3000.D*		958,00	785,25
	Brushed gold <i>Oro spazzolato</i> <i>Gold gebürstet</i> <i>Oro cepillado</i> <i>Брашированное золото</i>	2700 °K	1800.20.2700	109	858,00	703,28
			1800.20.2700.D*		958,00	785,25
		3000 °K	1800.20.3000		858,00	703,28
			1800.20.3000.D*		958,00	785,25
Brushed copper <i>Rame spazzolato</i> <i>Kupfer gebürstet</i> <i>Cobre cepillado</i> <i>Крацованная медь</i>	2700 °K	1801.20.2700	109	858,00	703,28	
		1801.20.2700.D*		958,00	785,25	
	3000 °K	1801.20.3000		858,00	703,28	
		1801.20.3000.D*		958,00	785,25	
 <p>ANELLO Ceiling lamp Ø 78</p>	Painted black <i>Nero verniciato</i> <i>Schwarz lackiert</i> <i>Negro pintado</i> <i>Окрашено в Черный</i>	2700 °K	1790.21.2700	109	1.044,00	855,74
			1790.21.2700.D*		1.144,00	937,70
			1790.21.2700.DT**		1.144,00	937,70
		3000 °K	1790.21.3000		1.044,00	855,74
			1790.21.3000.D*		1.144,00	937,70
			1790.21.3000.DT**		1.144,00	937,70
	Brushed bronze <i>Bronzo spazzolato</i> <i>Bronze gebürstet</i> <i>Bronce cepillado</i> <i>Брашированная бронза</i>	2700 °K	1799.21.2700	109	1.044,00	855,74
			1799.21.2700.D*		1.144,00	937,70
			1799.21.2700.DT**		1.144,00	937,70
		3000 °K	1799.21.3000		1.044,00	855,74
			1799.21.3000.D*		1.144,00	937,70
			1799.21.3000.DT**		1.144,00	937,70
	Brushed gold <i>Oro spazzolato</i> <i>Gold gebürstet</i> <i>Oro cepillado</i> <i>Брашированное золото</i>	2700 °K	1800.21.2700	109	1.044,00	855,74
			1800.21.2700.D*		1.144,00	937,70
			1800.21.2700.DT**		1.144,00	937,70
		3000 °K	1800.21.3000		1.044,00	855,74
			1800.21.3000.D*		1.144,00	937,70
			1800.21.3000.DT**		1.144,00	937,70
	Brushed copper <i>Rame spazzolato</i> <i>Kupfer gebürstet</i> <i>Cobre cepillado</i> <i>Крацованная медь</i>	2700 °K	1801.21.2700	109	1.044,00	855,74
			1801.21.2700.D*		1.144,00	937,70
			1801.21.2700.DT**		1.144,00	937,70
		3000 °K	1801.21.3000		1.044,00	855,74
			1801.21.3000.D*		1.144,00	937,70
			1801.21.3000.DT**		1.144,00	937,70

* Dimmable with: Push 0-10V/1-10V/Dali / normally open button
 Dimmerabile con: Push 0-10v / 1-10v/Dali / pulsante normalmente aperto
 Dimmbar über: Push 0-10V / 1-10V/Dali / Taste normalerweise offen
 Intensidad luminosa regulable con: Push 0-10v / 1-10v/Dali / botón normalmente abierto
 Диммируется с помощью Push 0-10 В / 1-10 В/Dali / с нормально разомкнутой кнопкой

PRODUCT	FINISHES	°K	CODE	PAGE	PRICE € incl VAT (22%)	PRICE € excl VAT
 <p>ANELLO Ceiling lamp Ø 109</p>	Painted black <i>Nero verniciato</i> <i>Schwarz lackiert</i> <i>Negro pintado</i> <i>Окрашено в Черный</i>	2700 °K	1790.22.2700	109	1.301,00	1.066,39
			1790.22.2700.D*		1.401,00	1.148,36
			1790.22.2700.DT**		1.401,00	1.148,36
		3000 °K	1790.22.3000		1.301,00	1.066,39
			1790.22.3000.D*		1.401,00	1.148,36
			1790.22.3000.DT**		1.401,00	1.148,36
	Brushed bronze <i>Bronzo spazzolato</i> <i>Bronze gebürstet</i> <i>Bronce cepillado</i> <i>Брашированная бронза</i>	2700 °K	1799.22.2700	109	1.301,00	1.066,39
			1799.22.2700.D*		1.401,00	1.148,36
			1799.22.2700.DT**		1.401,00	1.148,36
		3000 °K	1799.22.3000		1.301,00	1.066,39
			1799.22.3000.D*		1.401,00	1.148,36
			1799.22.3000.DT**		1.401,00	1.148,36
	Brushed gold <i>Oro spazzolato</i> <i>Gold gebürstet</i> <i>Oro cepillado</i> <i>Брашированное золото</i>	2700 °K	1800.22.2700	109	1.301,00	1.066,39
			1800.22.2700.D*		1.401,00	1.148,36
			1800.22.2700.DT**		1.401,00	1.148,36
		3000 °K	1800.22.3000		1.301,00	1.066,39
			1800.22.3000.D*		1.401,00	1.148,36
			1800.22.3000.DT**		1.401,00	1.148,36
	Brushed copper <i>Rame spazzolato</i> <i>Kupfer gebürstet</i> <i>Cobre cepillado</i> <i>Крацованная медь</i>	2700 °K	1801.22.2700	109	1.301,00	1.066,39
			1801.22.2700.D*		1.401,00	1.148,36
			1801.22.2700.DT**		1.401,00	1.148,36
		3000 °K	1801.22.3000		1.301,00	1.066,39
			1801.22.3000.D*		1.401,00	1.148,36
			1801.22.3000.DT**		1.401,00	1.148,36

* Dimmable with: Push 0-10V/1-10V/Dali / normally open button
 Dimmerabile con: Push 0-10v / 1-10v/Dali / pulsante normalmente aperto
 Dimmbar über: Push 0-10V / 1-10V/Dali / Taste normalerweise offen
 Intensidad luminosa regulable con: Push 0-10v / 1-10v/Dali / botón normalmente abierto
 Диммируется с помощью Push 0-10 В / 1-10 В/Dali / с нормально разомкнутой кнопкой

** Dimmable with: Triac
 Dimmerabile con: Triac
 Dimmbar über: Triac
 Intensidad luminosa regulable con: Triac
 Диммируется с помощью Triac

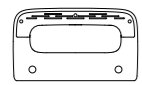
PRODUCT	FINISHES	°K	CODE	PAGE	PRICE € incl VAT (22%)	PRICE € excl VAT
 <p>22,3 cm</p> <p>AKI Wall lamp</p>	White <i>Bianco</i> Weiß <i>Blanco</i> Белый	2700 °K	1796.10.2700	147	292,00	239,34
			1796.10.2700.DP*		382,00	313,11
		3000 °K	1796.10.3000		292,00	239,34
			1796.10.3000.DP*		382,00	313,11
		4000 °K	1796.10.4000		292,00	239,34
			1796.10.4000.DP*		382,00	313,11
	Gold <i>Oro</i> Gold <i>Oro</i> Золото	2700 °K	1841.10.2700	147	292,00	239,34
			1841.10.2700.DP*		382,00	313,11
		3000 °K	1841.10.3000		292,00	239,34
			1841.10.3000.DP*		382,00	313,11
		4000 °K	1841.10.4000		292,00	239,34
			1841.10.4000.DP*		382,00	313,11
	Copper <i>Rame</i> Kupfer <i>Cobre</i> Медь	2700 °K	1835.10.2700	147	292,00	239,34
			1835.10.2700.DP*		382,00	313,11
		3000 °K	1835.10.3000		292,00	239,34
			1835.10.3000.DP*		382,00	313,11
		4000 °K	1835.10.4000		292,00	239,34
			1835.10.4000.DP*		382,00	313,11
	Bronze <i>Bronzo</i> Bronze <i>Bronce</i> Бронза	2700 °K	1798.10.2700	147	292,00	239,34
			1798.10.2700.DP*		382,00	313,11
		3000 °K	1798.10.3000		292,00	239,34
			1798.10.3000.DP*		382,00	313,11
		4000 °K	1798.10.4000		292,00	239,34
			1798.10.4000.DP*		382,00	313,11
Anthracite grey <i>Antracite</i> Anthrazit <i>Antracita</i> Антрацит	2700 °K	1823.10.2700	147	292,00	239,34	
		1823.10.2700.DP*		382,00	313,11	
	3000 °K	1823.10.3000		292,00	239,34	
		1823.10.3000.DP*		382,00	313,11	
	4000 °K	1823.10.4000		292,00	239,34	
		1823.10.4000.DP*		382,00	313,11	

* Dimmable with Push
Dimmerabile con Push
Dimmbar über Push
Intensidad luminosa regulable con Push
Диммируется с помощью Push

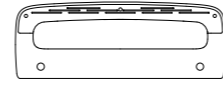
PRODUCT	FINISHES	°K	CODE	PAGE	PRICE € incl VAT (22%)	PRICE € excl VAT
 <p>35,5 cm</p> <p>AKI Wall lamp</p>	White <i>Bianco</i> Weiß <i>Blanco</i> Белый	2700 °K	1796.11.2700	147	354,00	290,16
			1796.11.2700.DP*		444,00	363,93
		3000 °K	1796.11.3000		354,00	290,16
			1796.11.3000.DP*		444,00	363,93
		4000 °K	1796.11.4000		354,00	290,16
			1796.11.4000.DP*		444,00	363,93
	Gold <i>Oro</i> Gold <i>Oro</i> Золото	2700 °K	1841.11.2700	147	354,00	290,16
			1841.11.2700.DP*		444,00	363,93
		3000 °K	1841.11.3000		354,00	290,16
			1841.11.3000.DP*		444,00	363,93
		4000 °K	1841.11.4000		354,00	290,16
			1841.11.4000.DP*		444,00	363,93
	Copper <i>Rame</i> Kupfer <i>Cobre</i> Медь	2700 °K	1835.11.2700	147	354,00	290,16
			1835.11.2700.DP*		444,00	363,93
		3000 °K	1835.11.3000		354,00	290,16
			1835.11.3000.DP*		444,00	363,93
		4000 °K	1835.11.4000		354,00	290,16
			1835.11.4000.DP*		444,00	363,93
	Bronze <i>Bronzo</i> Bronze <i>Bronce</i> Бронза	2700 °K	1798.11.2700	147	354,00	290,16
			1798.11.2700.DP*		444,00	363,93
		3000 °K	1798.11.3000		354,00	290,16
			1798.11.3000.DP*		444,00	363,93
		4000 °K	1798.11.4000		354,00	290,16
			1798.11.4000.DP*		444,00	363,93
Anthracite grey <i>Antracite</i> Anthrazit <i>Antracita</i> Антрацит	2700 °K	1823.11.2700	147	354,00	290,16	
		1823.11.2700.DP*		444,00	363,93	
	3000 °K	1823.11.3000		354,00	290,16	
		1823.11.3000.DP*		444,00	363,93	
	4000 °K	1823.11.4000		354,00	290,16	
		1823.11.4000.DP*		444,00	363,93	

* Dimmable with Push
Dimmerabile con Push
Dimmbar über Push
Intensidad luminosa regulable con Push
Диммируется с помощью Push

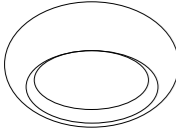
PRODUCT	FINISHES	°K	CODE	PAGE	PRICE € incl VAT (22%)	PRICE € excl VAT
 <p>OLO Wall lamp</p>	White <i>Bianco</i> Weiß Blanco Белый	2700 °K	1776.10.2700	163	293,00	240,16
		3000 °K	1776.10.3000		293,00	240,16
		4000 °K	1776.10.4000		293,00	240,16
	Brushed gold <i>Oro spazzolato</i> Gold gebürstet Oro cepillado Брашированное золото	2700 °K	1791.10.2700	163	293,00	240,16
		3000 °K	1791.10.3000		293,00	240,16
		4000 °K	1791.10.4000		293,00	240,16
	Brushed copper <i>Rame spazzolato</i> Kupfer gebürstet Cobre cepillado Крацованная медь	2700 °K	1792.10.2700	163	293,00	240,16
		3000 °K	1792.10.3000		293,00	240,16
		4000 °K	1792.10.4000		293,00	240,16
	Brushed bronze <i>Bronzo spazzolato</i> Bronze gebürstet Bronce cepillado Брашированная бронза	2700 °K	1793.10.2700	163	293,00	240,16
		3000 °K	1793.10.3000		293,00	240,16
		4000 °K	1793.10.4000		293,00	240,16
Anthracite grey Anthracite Anthrazit Antracita Антрацит	2700 °K	1824.10.2700	163	293,00	240,16	
	3000 °K	1824.10.3000		293,00	240,16	
	4000 °K	1824.10.4000		293,00	240,16	

PRODUCT	CODE	PAGE	PRICE € incl VAT (22%)	PRICE € excl VAT
Remote dimmer controller. Controls up to 6 lamps <i>Dimmer remoto. Gestisce fino a 6 lampade</i> Dimmer-Fernbedienung. Verwaltet bis zu 6 Leuchten Regulador de intensidad remoto. Controla hasta 6 bombillas Диммер дистанционного управления. Управляет макс. 6 лампами	1776.DIM	163	125,00	102,46
Casambi dimmer controller. Controls up to 4 lamps <i>Dimmer casambi. Gestisce fino a 4 lampade</i> Casambi-Dimmer. Verwaltet bis zu 4 Leuchten Regulador de intensidad Casambi. Controla hasta 4 bombillas Контроллер-диммер Casambi. Управляет макс. 4 лампами	1776.CASAMBI		175,00	143,44

Wall-wall mounting

Montaggio Parete/Parete, installazione "Tesata" / Wand/Wand-Montage, Installationsmethode "Tesata" /
Montaje en Pared/Pared, instalación "Tesata" / Монтаж от стены до стены, установка с натяжкой

MODEL	PRODUCT
Remote power supply / Alimentatore remoto / Entfernt liegendes Netzteil / Fuente de alimentación remota / Блок дистанционного питания	
A	
B	
C	
Built-in power supply / Alimentatore a bordo / Integriertes Netzteil / Fuente de alimentación integrada / Встроенный блок питания	
D	
E	

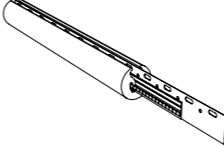

Wall-wall

Luminaire / Corpo illuminante / Beleuchtungskörper / Luminaria / Светильник

PRODUCT	FINISHES	MT.	°K	CODE	PAGE	PRICE € incl VAT (22%)	PRICE € excl VAT
	Complete LED line, steel, silicone Linea completa Led, Acciaio, Silicone Linea, komplett mit LED, Stahl & Silikon Linea completa LED, acero, silicona Комплексная светодиодная линейка, сталь, силикон	1	2700 °K	1795.L1.2700	175	234,00	191,80
		2	2700 °K	1795.L2.2700	175	387,00	317,21
		3	2700 °K	1795.L3.2700	175	539,00	441,80
		4	2700 °K	1795.L4.2700	175	710,00	581,97
		5	2700 °K	1795.L5.2700	175	862,00	706,56
		6	2700 °K	1795.L6.2700	175	1.015,00	831,97
		7	2700 °K	1795.L7.2700	175	1.187,00	972,95
		8	2700 °K	1795.L8.2700	175	1.339,00	1.097,54
		9	2700 °K	1795.L9.2700	175	1.491,00	1.222,13
		10	2700 °K	1795.L10.2700	175	1.644,00	1.347,54
		1	3000 °K	1795.L1.3000	175	234,00	191,80
		2	3000 °K	1795.L2.3000	175	387,00	317,21
		3	3000 °K	1795.L3.3000	175	539,00	441,80
		4	3000 °K	1795.L4.3000	175	710,00	581,97
		5	3000 °K	1795.L5.3000	175	862,00	706,56
		6	3000 °K	1795.L6.3000	175	1.015,00	831,97
		7	3000 °K	1795.L7.3000	175	1.187,00	972,95
		8	3000 °K	1795.L8.3000	175	1.339,00	1.097,54
		9	3000 °K	1795.L9.3000	175	1.491,00	1.222,13
		10	3000 °K	1795.L10.3000	175	1.644,00	1.347,54

Wall-wall

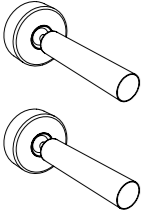
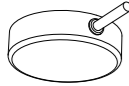
Accessories / Accessori / Zubehör / Accesorios / Аксессуары

ACCESSORIES	FINISHES	CODE	PRICE € incl VAT (22%)	PRICE € excl VAT
 <p>Terminal connections (2pcs) Attacchi terminali (2pc) Endanschlüsse (2 Stck.) Fijaciones terminales (2 uds.) Выходы (2 шт.)</p>	Brushed aluminium Alluminio spazzolato Gebürstetes Aluminium Aluminio cepillado Крацованный алюминий	1795.M1	382,00	313,11
	Black Nero Schwarz Negro Черный	1810.M1	382,00	313,11
	Sand Sabbia Sand Arena Песочный	1811.M1	382,00	313,11
 <p>Remote driver ceiling canopy Rosone per driver remoto Baldachin für entfernt liegenden Driver Rosetón para controlador remoto Потолочная чашка для выносного драйвера</p> <p>Only B and C with remote power supply Solo B e C e con alimentatore remoto Nur B und C mit entfernt liegendem Netzteil Solo B y C y con fuente de alimentación remota Только B и C с блоком дистанционного питания</p>	Brushed aluminium Alluminio spazzolato Gebürstetes Aluminium Aluminio cepillado Крацованный алюминий	1795.M4	77,00	63,11
	Black Nero Schwarz Negro Черный	1810.M4	77,00	63,11
	Sand Sabbia Sand Arena Песочный	1811.M4	77,00	63,11
 <p>Power cable grip Blossacavo per cavo alimentazione Kabelklemme für Netzkabel Sujetacables para cable de alimentación Зажим для шнура питания</p> <p>C only / Solo C / Nur C / Solo C / Только C</p>	Brushed aluminium Alluminio spazzolato Gebürstetes Aluminium Aluminio cepillado Крацованный алюминий	1795.M5	23,00	18,85
	Black Nero Schwarz Negro Черный	1810.M5	23,00	18,85
	Sand Sabbia Sand Arena Песочный	1811.M5	23,00	18,85

Wall-wall

Drivers and ceiling canopies / Driver e rosone / Driver und Baldachine / Controladores y rosetones / Драйверы и основания

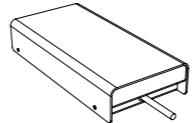
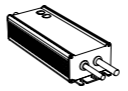
ACCESSORIES	FINISHES	W	Max MT	CODE	PRICE € incl VAT (22%)	PRICE € excl VAT
 <p>Power supply with cover Alimentatore con cover Netzteil mit Abdeckung Fuente de alimentación con cubierta Блок питания с крышкой</p>	Brushed aluminium Alluminio spazzolato Gebürstetes Aluminium Aluminio cepillado Крацованный алюминий	75W On-Off	Max 3.5 mt	1795.B1	140,00	114,75
		150W On-Off	Max 7.5 mt	1795.B2	159,00	130,33
		200W On-Off	Max 10 mt	1795.B3	252,00	206,56
		60W Dimmer	Max 3 mt	1795.B4*	205,00	168,03
		120W Dimmer	Max 6 mt	1795.B5*	260,00	213,11
		240W Dimmer	Max 10 mt	1795.B6*	310,00	254,10
	Black Nero Schwarz Negro Черный	75W On-Off	Max 3.5 mt	1810.B1	140,00	114,75
		150W On-Off	Max 7.5 mt	1810.B2	159,00	130,33
		200W On-Off	Max 10 mt	1810.B3	252,00	206,56
		60W Dimmer	Max 3 mt	1810.B4*	205,00	168,03
		120W Dimmer	Max 6 mt	1810.B5*	260,00	213,11
		240W Dimmer	Max 10 mt	1810.B6*	310,00	254,10
	Sand Sabbia Sandfarben Arena Песочный	75W On-Off	Max 3.5 mt	1811.B1	140,00	114,75
		150W On-Off	Max 7.5 mt	1811.B2	159,00	130,33
		200W On-Off	Max 10 mt	1811.B3	252,00	206,56
		60W Dimmer	Max 3 mt	1811.B4*	205,00	168,03
		120W Dimmer	Max 6 mt	1811.B5*	260,00	213,11
		240W Dimmer	Max 10 mt	1811.B6*	310,00	254,10
 <p>Remote power supply Alimentatore remoto Entfernt liegendes Netzteil Fuente de alimentación remota Блок дистанционного питания</p>	75W On-Off	Max 3.5 mt	1795.R1	54,00	44,26	
	150W On-Off	Max 7.5 mt	1795.R2	73,00	59,84	
	200W On-Off	Max 10 mt	1795.R3	165,00	135,25	
	60W Dimmer	Max 3 mt	1795.R4*	113,00	92,62	
	120W Dimmer	Max 6 mt	1795.R5*	168,00	137,70	
	240W Dimmer	Max 12 mt	1795.R6*	218,00	178,69	

* Up to 2 m, calculate 2 pcs + (1 x m) / over 3 m, calculate 1 pc + (1 x m) / Fino a 2 m calcolare 2 pcs + (1 x m) / oltre i 3 m calcolare 1 pc + (1 x m) / Bis zu 2 m 2 Stck. berechnen (1 pro m) / bei mehr als 3 m 1 Stck. + (1 pro m) berechnen / Hasta 2 m calcular 2 uds. + (1 x m) / A partir de 3 m calcular 1 ud. + (1 x m) / До 2 м нужно учитывать 2 шт. + (1 x m) / свыше 3 м нужно учитывать 1 шт. + (1 x m)

* Dimmable with: 1 ~ 10Vdc, 10V PWM signal and resistance
Dimmerabile con: 1 ~ 10Vdc, 10V PWM segnale e resistenza
Dimmbar über: 1~10Vdc, 10V PWM-Signal und Widerstand
Intensidad luminosa regulable con: 1 ~ 10 Vcc, 10 V PWM señal y resistencia
Диммируется с помощью 1 ~ 10 В постоянн. тока, ШИМ-сигнала 10 В и резистора

Surface mounting

Montaggio Superficiale, installazione "Parete-Soffitto" / Aufputzmontage, Installation Wand-Decke /
Montaje en superficie, instalación Pared-Techo / Поверхностный монтаж, установка «стена-потолок»

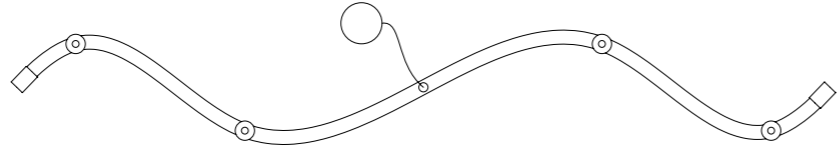
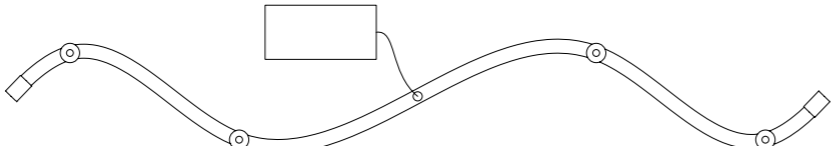
MODEL	PRODUCT
A	
B	

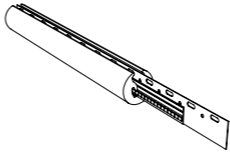

Surface mounting

Luminaire / Corpo illuminante / Beleuchtungskörper / Luminaria / Светильник

PRODUCT	FINISHES	MT.	°K	CODE	PAGE	PRICE € incl VAT (22%)	PRICE € excl VAT
	Complete LED line, steel, silicone <i>Linea completa Led, Acciaio, Silicone</i> <i>Linea, komplett mit LED, Stahl & Silikon</i> <i>Linea completa LED, acero, silicona</i> <i>Комплексная светодиодная линейка, сталь, силикон</i>	1	2700 °K	1795.L1.2700	185	234,00	191,80
		2	2700 °K	1795.L2.2700	185	387,00	317,21
		3	2700 °K	1795.L3.2700	185	539,00	441,80
		4	2700 °K	1795.L4.2700	185	710,00	581,97
		5	2700 °K	1795.L5.2700	185	862,00	706,56
		6	2700 °K	1795.L6.2700	185	1.015,00	831,97
		7	2700 °K	1795.L7.2700	185	1.187,00	972,95
		8	2700 °K	1795.L8.2700	185	1.339,00	1.097,54
		9	2700 °K	1795.L9.2700	185	1.491,00	1.222,13
		10	2700 °K	1795.L10.2700	185	1.644,00	1.347,54
		1	3000 °K	1795.L1.3000	185	234,00	191,80
		2	3000 °K	1795.L2.3000	185	387,00	317,21
		3	3000 °K	1795.L3.3000	185	539,00	441,80
		4	3000 °K	1795.L4.3000	185	710,00	581,97
		5	3000 °K	1795.L5.3000	185	862,00	706,56
		6	3000 °K	1795.L6.3000	185	1.015,00	831,97
		7	3000 °K	1795.L7.3000	185	1.187,00	972,95
		8	3000 °K	1795.L8.3000	185	1.339,00	1.097,54
		9	3000 °K	1795.L9.3000	185	1.491,00	1.222,13
		10	3000 °K	1795.L10.3000	185	1.644,00	1.347,54

Surface mounting

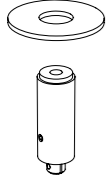
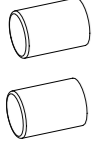
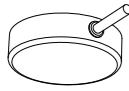
Accessories / Accessori / Zubehör / Accesorios / Аксессуары

ACCESSORIES	FINISHES	CODE	PRICE € incl VAT (22%)	PRICE € excl VAT
	Brushed aluminium Alluminio spazzolato Gebürstetes Aluminium Aluminio cepillado Крацованный алюминий	1795.M2	33,00	27,05
	Black Nero Schwarz Negro Черный	1810.M2	33,00	27,05
	Sand Sabbia Sand Arena Песочный	1811.M2	33,00	27,05
	Brushed aluminium Alluminio spazzolato Gebürstetes Aluminium Aluminio cepillado Крацованный алюминий	1795.M3	42,00	34,43
	Black Nero Schwarz Negro Черный	1810.M3	42,00	34,43
	Sand Sabbia Sand Arena Песочный	1811.M3	42,00	34,43
	Brushed aluminium Alluminio spazzolato Gebürstetes Aluminium Aluminio cepillado Крацованный алюминий	1795.M4	77,00	63,11
	Black Nero Schwarz Negro Черный	1810.M4	77,00	63,11
	Sand Sabbia Sand Arena Песочный	1811.M4	77,00	63,11
	Brushed aluminium Alluminio spazzolato Gebürstetes Aluminium Aluminio cepillado Крацованный алюминий	1795.M5	23,00	18,85
	Black Nero Schwarz Negro Черный	1810.M5	23,00	18,85
	Sand Sabbia Sand Arena Песочный	1811.M5	23,00	18,85

* Up to 2 m, calculate 2 pcs + (1 x m) / over 3 m, calculate 1 pc + (1 x m) / Fino a 2 m calcolare 2 pcs + (1 x m) / oltre i 3 m calcolare 1 pc + (1 x m) / Bis zu 2 m 2 Stck. berechnen (1 pro m) / bei mehr als 3 m 1 Stck. + (1 pro m) berechnen / Hasta 2 m calcular 2 uds. + (1 x m) / A partir de 3 m calcular 1 ud. + (1 x m) / До 2 м нужно учитывать 2 шт. + (1 x m) / свыше 3 м нужно учитывать 1 шт. + (1 x m)

Surface mounting

Drivers and canopies / Driver e rosoni / Driver und Baldachine / Controladores y rosetones / Драйверы и основания

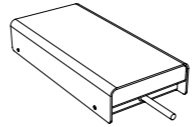
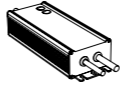
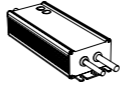
ACCESSORIES	FINISHES	W	Max MT	CODE	PRICE € incl VAT (22%)	PRICE € excl VAT
	Brushed aluminium Alluminio spazzolato Gebürstetes Aluminium Aluminio cepillado Крацованный алюминий	75W On-Off	Max 3.5 mt	1795.B1	140,00	114,75
		150W On-Off	Max 7.5 mt	1795.B2	159,00	130,33
		200W On-Off	Max 10 mt	1795.B3	252,00	206,56
		60W Dimmer	Max 3 mt	1795.B4*	205,00	168,03
		120W Dimmer	Max 6 mt	1795.B5*	260,00	213,11
		240W Dimmer	Max 10 mt	1795.B6*	310,00	254,10
B only / Solo B / Nur B / Solo B / Только B	Black Nero Schwarz Negro Черный	75W On-Off	Max 3.5 mt	1810.B1	140,00	114,75
		150W On-Off	Max 7.5 mt	1810.B2	159,00	130,33
		200W On-Off	Max 10 mt	1810.B3	252,00	206,56
		60W Dimmer	Max 3 mt	1810.B4*	205,00	168,03
		120W Dimmer	Max 6 mt	1810.B5*	260,00	213,11
		240W Dimmer	Max 10 mt	1810.B6*	310,00	254,10
	Sand Sabbia Sand Arena Песочный	75W On-Off	Max 3.5 mt	1811.B1	140,00	114,75
		150W On-Off	Max 7.5 mt	1811.B2	159,00	130,33
		200W On-Off	Max 10 mt	1811.B3	252,00	206,56
		60W Dimmer	Max 3 mt	1811.B4*	205,00	168,03
		120W Dimmer	Max 6 mt	1811.B5*	260,00	213,11
		240W Dimmer	Max 10 mt	1811.B6*	310,00	254,10
	Remote power supply Alimentatore remoto Entfernt liegendes Netzteil Fuente de alimentación remota Удаленный блок питания	75W On-Off	Max 3.5 mt	1795.R1	54,00	44,26
		150W On-Off	Max 7.5 mt	1795.R2	73,00	59,84
		200W On-Off	Max 10 mt	1795.R3	165,00	135,25
		60W Dimmer	Max 3 mt	1795.R4*	113,00	92,62
		120W Dimmer	Max 6 mt	1795.R5*	168,00	137,70
		240W Dimmer	Max 12 mt	1795.R6*	218,00	178,69

* Dimmable with: 1 ~ 10Vdc, 10V PWM signal and resistance
Dimmerabile con: 1 ~ 10Vdc, 10V PWM segnale e resistenza
Dimmbar über: 1~10Vdc, 10V PWM-Signal und Widerstand
Intensidad luminosa regulable con: 1 ~ 10 Vcc, 10 V PWM señal y resistencia
Диммируется с помощью 1 ~ 10 В постоянн. тока, ШИМ-сигнала 10 В и резистора

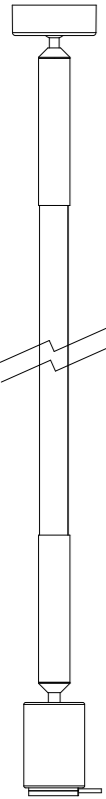

Vertical suspension

Sospensione verticale / Vertikale Aufhängung / Suspensión vertical / Вертикальное подвешивание

PRODUCT		FINISHES	°K	CODE	PAGE	PRICE € incl VAT (22%)	PRICE € excl VAT
 <p>LINEA System</p>	<p>3 m vertical suspension line (can be shortened to the desired measure) <i>Linea sospensione verticale 3 m accorciabile a misura</i> <i>Linea vertikale Aufhängung 3m nach Maß kürzbar</i> <i>Línea suspensión vertical 3 m, puede cortarse a medida</i> <i>Держатель для вертикального подвешивания длиной 3 м, укорачивается по индивидуальным размерам</i></p>	<p>Brushed aluminium <i>Alluminio spazzolato</i> <i>Gebürstetes Aluminium</i> <i>Aluminio cepillado</i> <i>Крацованный алюминий</i></p>	2700 °K	1795.S4.2700	189	856,00	701,64
			3000 °K	1795.S4.3000	189	856,00	701,64
		<p>Black <i>Nero</i> <i>Schwarz</i> <i>Negro</i> <i>Черный</i></p>	2700 °K	1810.S4.2700	189	942,00	772,13
			3000 °K	1810.S4.3000	189	942,00	772,13
		<p>Sand <i>Sabbia</i> <i>Sand</i> <i>Arena</i> <i>Песочный</i></p>	2700 °K	1811.S4.2700	189	942,00	772,13
			3000 °K	1811.S4.3000	189	942,00	772,13



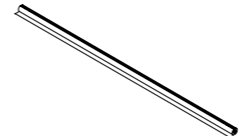

Horizontal suspension

Sospensione orizzontale / Horizontale Aufhängung / Suspensión horizontal / Горизонтальное подвешивание

PRODUCT		°K	CODE	PAGE	PRICE € incl VAT (22%)	PRICE € excl VAT
 <p>LINEA System</p>	<p>Linear element <i>Elemento lineare</i> <i>Lineares Element</i> <i>Elemento lineal</i> <i>Линейный элемент</i></p> <p>120 cm - 24W</p>	2700 °K	1795.S1.2700	197	473,00	387,70
		3000 °K	1795.S1.3000	197	473,00	387,70
 <p>LINEA System</p>	<p>90° bend <i>Curva 90°</i> <i>Kurve 90°</i> <i>Curva 90°</i> <i>Изогнутый элемент 90°</i></p> <p>11W</p>	2700 °K	1795.S2.2700	197	326,00	267,21
		3000 °K	1795.S2.3000	197	326,00	267,21
 <p>LINEA System</p>	<p>180° bend <i>Curva 180°</i> <i>Kurve 180°</i> <i>Curva 180°</i> <i>Изогнутый элемент 180°</i></p> <p>20W</p>	2700 °K	1795.S3.2700	197	423,00	346,72
		3000 °K	1795.S3.3000	197	423,00	346,72

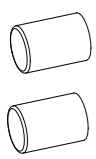
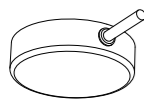
Horizontal suspension

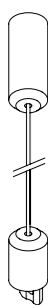
Accessories / Accessori / Zubehör / Accesorios / Аксессуары

ACCESSORIES	FINISHES	CODE	PRICE € incl VAT (22%)	PRICE € excl VAT
	Brushed aluminium <i>Alluminio spazzolato</i> <i>Gebürstetes Aluminium</i> <i>Aluminio cepillado</i> <i>Крацованный алюминий</i>	1795.M3	42,00	34,43
	Black <i>Nero</i> <i>Schwarz</i> <i>Negro</i> <i>Черный</i>	1810.M3	42,00	34,43
	Sand <i>Sabbia</i> <i>Sand</i> <i>Arena</i> <i>Песочный</i>	1811.M3	42,00	34,43
	Brushed aluminium <i>Alluminio spazzolato</i> <i>Gebürstetes Aluminium</i> <i>Aluminio cepillado</i> <i>Крацованный алюминий</i>	1795.M4	77,00	63,11
	Black <i>Nero</i> <i>Schwarz</i> <i>Negro</i> <i>Черный</i>	1810.M4	77,00	63,11
	Sand <i>Sabbia</i> <i>Sand</i> <i>Arena</i> <i>Песочный</i>	1811.M4	77,00	63,11
	Brushed aluminium <i>Alluminio spazzolato</i> <i>Gebürstetes Aluminium</i> <i>Aluminio cepillado</i> <i>Крацованный алюминий</i>	1795.M5	23,00	18,85
	Black <i>Nero</i> <i>Schwarz</i> <i>Negro</i> <i>Черный</i>	1810.M5	23,00	18,85
	Sand <i>Sabbia</i> <i>Sand</i> <i>Arena</i> <i>Песочный</i>	1811.M5	23,00	18,85
	Brushed aluminium <i>Alluminio spazzolato</i> <i>Gebürstetes Aluminium</i> <i>Aluminio cepillado</i> <i>Крацованный алюминий</i>	1795.M6	61,00	50,00
	Black <i>Nero</i> <i>Schwarz</i> <i>Negro</i> <i>Черный</i>	1810.M6	61,00	50,00
	Sand <i>Sabbia</i> <i>Sand</i> <i>Arena</i> <i>Песочный</i>	1811.M6	61,00	50,00
	Brushed aluminium <i>Alluminio spazzolato</i> <i>Gebürstetes Aluminium</i> <i>Aluminio cepillado</i> <i>Крацованный алюминий</i>	1795.M7	20,00	16,39
	Black <i>Nero</i> <i>Schwarz</i> <i>Negro</i> <i>Черный</i>	1810.M7	20,00	16,39
	Sand <i>Sabbia</i> <i>Sand</i> <i>Arena</i> <i>Песочный</i>	1811.M7	20,00	16,39

* Up to 2 m, calculate 2 pcs + (1 x m) / over 3 m, calculate 1 pc + (1 x m) / Fino a 2 m calcolare 2 pcs + (1 x m) / oltre i 3 m calcolare 1 pc + (1 x m) / Bis zu 2 m 2 Stck. berechnen (1 pro m) / bei mehr als 3 m 1 Stck. + (1 pro m) berechnen / Hasta 2 m calcular 2 uds. + (1 x m) / A partir de 3 m calcular 1 ud. + (1 x m) / До 2 м нужно учитывать 2 шт. + (1 x m) / свыше 3 м нужно учитывать 1 шт. + (1 x m)

Horizontal suspension

Drivers and canopies / Driver e rosoni / Driver und Baldachin / Controladores y rosetones / Драйверы и основания

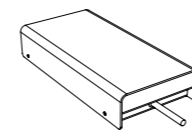
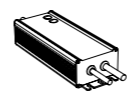
ACCESSORIES	FINISHES	W	Max MT	CODE	PRICE € incl VAT (22%)	PRICE € excl VAT
	Brushed aluminium <i>Alluminio spazzolato</i> <i>Gebürstetes Aluminium</i> <i>Aluminio cepillado</i> <i>Крацованный алюминий</i>	75W On-Off	Max 3.5 mt	1795.B1	140,00	114,75
		150W On-Off	Max 7.5 mt	1795.B2	159,00	130,33
		200W On-Off	Max 10 mt	1795.B3	252,00	206,56
		60W Dimmer	Max 3 mt	1795.B4*	205,00	168,03
		120W Dimmer	Max 6 mt	1795.B5*	260,00	213,11
		240W Dimmer	Max 10 mt	1795.B6*	310,00	254,10
	Black <i>Nero</i> <i>Schwarz</i> <i>Negro</i> <i>Черный</i>	75W On-Off	Max 3.5 mt	1810.B1	140,00	114,75
		150W On-Off	Max 7.5 mt	1810.B2	159,00	130,33
		200W On-Off	Max 10 mt	1810.B3	252,00	206,56
		60W Dimmer	Max 3 mt	1810.B4*	205,00	168,03
		120W Dimmer	Max 6 mt	1810.B5*	260,00	213,11
		240W Dimmer	Max 10 mt	1810.B6*	310,00	254,10
Sand <i>Sabbia</i> <i>Sand</i> <i>Arena</i> <i>Песочный</i>	75W On-Off	Max 3.5 mt	1811.B1	140,00	114,75	
	150W On-Off	Max 7.5 mt	1811.B2	159,00	130,33	
	200W On-Off	Max 10 mt	1811.B3	252,00	206,56	
	60W Dimmer	Max 3 mt	1811.B4*	205,00	168,03	
	120W Dimmer	Max 6 mt	1811.B5*	260,00	213,11	
	240W Dimmer	Max 10 mt	1811.B6*	310,00	254,10	
	Remote power supply <i>Alimentatore remoto</i> <i>Entfernt liegendes Netzteil</i> <i>Fuente de alimentación remota</i> <i>Блок дистанционного питания</i>	75W On-Off	Max 3.5 mt	1795.R1	54,00	44,26
		150W On-Off	Max 7.5 mt	1795.R2	73,00	59,84
		200W On-Off	Max 10 mt	1795.R3	165,00	135,25
		60W Dimmer	Max 3 mt	1795.R4*	113,00	92,62
		120W Dimmer	Max 6 mt	1795.R5*	168,00	137,70
		240W Dimmer	Max 12 mt	1795.R6*	218,00	178,69

* Dimmable with: 1 ~ 10Vdc, 10V PWM signal and resistance
Dimmerabile con: 1 ~ 10Vdc, 10V PWM segnale e resistenza
Dimmbar über: 1~10Vdc, 10V PWM-Signal und Widerstand
Intensidad luminosa regulable con: 1 ~ 10 Vcc, 10 V PWM señal y resistencia
Диммируется с помощью 1 ~ 10 В постоянн. тока, ШИМ-сигнала 10 В и резистора

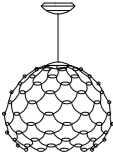

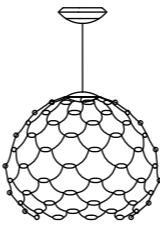
PRODUCT	FINISHES	°K	CODE	PAGE	PRICE € incl VAT (22%)	PRICE € excl VAT	
 <p>LAMO I Suspension lamp Ø 40</p>	Gold Oro Gold Oro Золото	2700 °K	1812.30.2700	215	1.091,00	894,26	
			1812.30.2700.D*		1.191,00	976,23	
		3000 °K	1812.30.3000		1.091,00	894,26	
			1812.30.3000.D*		1.191,00	976,23	
	Plastic covers, Coperture plastica, Kunststoffabdeckungen, Cubiertas de plástico, Пластиковые крышки			1812.30.KIT.COVER		208,00	170,49
	Copper Rame Kupfer Cobre Медь	2700 °K	1816.30.2700	215	1.091,00	894,26	
			1816.30.2700.D*		1.191,00	976,23	
		3000 °K	1816.30.3000		1.091,00	894,26	
			1816.30.3000.D*		1.191,00	976,23	
	Plastic covers, Coperture plastica, Kunststoffabdeckungen, Cubiertas de plástico, Пластиковые крышки			1816.30.KIT.COVER		208,00	170,49
	Chrome Cromo Chrom Cromo Хром	2700 °K	1817.30.2700	215	1.091,00	894,26	
			1817.30.2700.D*		1.191,00	976,23	
3000 °K		1817.30.3000	1.091,00		894,26		
		1817.30.3000.D*	1.191,00		976,23		
Plastic covers, Coperture plastica, Kunststoffabdeckungen, Cubiertas de plástico, Пластиковые крышки			1817.30.KIT.COVER		208,00	170,49	

PRODUCT	FINISHES	°K	CODE	PAGE	PRICE € incl VAT (22%)	PRICE € excl VAT	
 <p>LAMO I Suspension lamp Ø 80</p>	Gold Oro Gold Oro Золото	2700 °K	1812.32.2700	215	1.843,00	1.510,66	
			1812.32.2700.D*		1.943,00	1.592,62	
		3000 °K	1812.32.3000		1.843,00	1.510,66	
			1812.32.3000.D*		1.943,00	1.592,62	
	Plastic covers, Coperture plastica, Kunststoffabdeckungen, Cubiertas de plástico, Пластиковые крышки			1812.32.KIT.COVER		421,00	345,08
	Copper Rame Kupfer Cobre Медь	2700 °K	1816.32.2700	215	1.843,00	1.510,66	
			1816.32.2700.D*		1.943,00	1.592,62	
		3000 °K	1816.32.3000		1.843,00	1.510,66	
			1816.32.3000.D*		1.943,00	1.592,62	
	Plastic covers, Coperture plastica, Kunststoffabdeckungen, Cubiertas de plástico, Пластиковые крышки			1816.32.KIT.COVER		421,00	345,08
	Chrome Cromo Chrom Cromo Хром	2700 °K	1817.32.2700	215	1.843,00	1.510,66	
			1817.32.2700.D*		1.943,00	1.592,62	
3000 °K		1817.32.3000	1.843,00		1.510,66		
		1817.32.3000.D*	1.943,00		1.592,62		
Plastic covers, Coperture plastica, Kunststoffabdeckungen, Cubiertas de plástico, Пластиковые крышки			1817.32.KIT.COVER		421,00	345,08	

* Dimmable with: Push 0-10V/1-10V/Dali / normally open button
 Dimmerabile con: Push 0-10v / 1-10v/Dali / pulsante normalmente aperto
 Dimmbar über: Push 0-10V / 1-10V/Dali / Taste normalerweise offen
 Intensidad luminosa regulable con: Push 0-10v / 1-10v/Dali / botón normalmente abierto
 Диммируется с помощью Push 0-10 В / 1-10 В/Dali / с нормально разомкнутой кнопкой

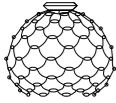
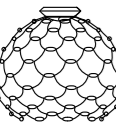
** Dimmable with: Triac
 Dimmerabile con: Triac
 Dimmbar über: Triac
 Intensidad luminosa regulable con: Triac
 Диммируется с помощью Triac

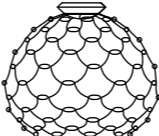
PRODUCT	FINISHES	°K	CODE	PAGE	PRICE € incl VAT (22%)	PRICE € excl VAT	
 <p>LAMO I Ceiling lamp Ø 40</p>	Gold Oro Gold Oro Золото	2700 °K	1812.20.2700	227	1.061,00	869,67	
			1812.20.2700.D*		1.161,00	951,64	
		3000 °K	1812.20.3000		1.061,00	869,67	
			1812.20.3000.D*		1.161,00	951,64	
	Plastic covers, Coperture plastica, Kunststoffabdeckungen, Cubiertas de plástico, Пластиковые крышки				1812.20.KIT.COVER	208,00	170,49
	Copper Rame Kupfer Cobre Медь	2700 °K	1816.20.2700		227	1.061,00	869,67
			1816.20.2700.D*			1.161,00	951,64
		3000 °K	1816.20.3000			1.061,00	869,67
			1816.20.3000.D*	1.161,00		951,64	
	Plastic covers, Coperture plastica, Kunststoffabdeckungen, Cubiertas de plástico, Пластиковые крышки			1816.20.KIT.COVER		208,00	170,49
	Chrome Cromo Chrom Cromo Хром	2700 °K	1817.20.2700	227		1.061,00	869,67
			1817.20.2700.D*			1.161,00	951,64
3000 °K		1817.20.3000	1.061,00			869,67	
		1817.20.3000.D*	1.161,00		951,64		
Plastic covers, Coperture plastica, Kunststoffabdeckungen, Cubiertas de plástico, Пластиковые крышки			1817.20.KIT.COVER		208,00	170,49	
 <p>LAMO I Ceiling lamp Ø 60</p>	Gold Oro Gold Oro Золото	2700 °K	1812.21.2700		227	1.368,00	1.121,31
			1812.21.2700.D*			1.468,00	1.203,28
			1812.21.2700.DT**			1.468,00	1.203,28
		3000 °K	1812.21.3000	1.368,00		1.121,31	
			1812.21.3000.D*	1.468,00		1.203,28	
	Plastic covers, Coperture plastica, Kunststoffabdeckungen, Cubiertas de plástico, Пластиковые крышки			1812.21.KIT.COVER		305,00	250,00
	Copper Rame Kupfer Cobre Медь	2700 °K	1816.21.2700	227		1.368,00	1.121,31
			1816.21.2700.D*			1.468,00	1.203,28
			1816.21.2700.DT**			1.468,00	1.203,28
		3000 °K	1816.21.3000			1.368,00	1.121,31
1816.21.3000.D*			1.468,00		1.203,28		
1816.21.3000.DT*			1.468,00		1.203,28		
Plastic covers, Coperture plastica, Kunststoffabdeckungen, Cubiertas de plástico, Пластиковые крышки			1816.21.KIT.COVER	305,00	250,00		
Chrome Cromo Chrom Cromo Хром	2700 °K	1817.21.2700	227	1.368,00	1.121,31		
		1817.21.2700.D*		1.468,00	1.203,28		
		1817.21.2700.DT**		1.468,00	1.203,28		
	3000 °K	1817.21.3000		1.368,00	1.121,31		
		1817.21.3000.D*		1.468,00	1.203,28		
		1817.21.3000.DT**		1.468,00	1.203,28		
Plastic covers, Coperture plastica, Kunststoffabdeckungen, Cubiertas de plástico, Пластиковые крышки			1817.21.KIT.COVER	305,00	250,00		

PRODUCT	FINISHES	°K	CODE	PAGE	PRICE € incl VAT (22%)	PRICE € excl VAT			
 <p>LAMO I Ceiling lamp Ø 80</p>	Gold Oro Gold Oro Золото	2700 °K	1812.22.2700	227	1.813,00	1.486,07			
			1812.22.2700.D*		1.913,00	1.568,03			
		3000 °K	1812.22.3000		1.813,00	1.486,07			
			1812.22.3000.D*		1.913,00	1.568,03			
	Plastic covers, Coperture plastica, Kunststoffabdeckungen, Cubiertas de plástico, Пластиковые крышки				1812.22.KIT.COVER	420,00	344,26		
	Copper Rame Kupfer Cobre Медь	2700 °K	1816.22.2700		227	1.813,00	1.486,07		
			1816.22.2700.D*			1.913,00	1.568,03		
		3000 °K	1816.22.3000			1.813,00	1.486,07		
			1816.22.3000.D*	1.913,00		1.568,03			
	Plastic covers, Coperture plastica, Kunststoffabdeckungen, Cubiertas de plástico, Пластиковые крышки			1816.22.KIT.COVER		420,00	344,26		
	Chrome Cromo Chrom Cromo Хром	2700 °K	1817.22.2700	227		1.813,00	1.486,07		
			1817.22.2700.D*			1.913,00	1.568,03		
3000 °K		1817.22.3000	1.813,00			1.486,07			
		1817.22.3000.D*	1.913,00		1.568,03				
Plastic covers, Coperture plastica, Kunststoffabdeckungen, Cubiertas de plástico, Пластиковые крышки			1817.22.KIT.COVER		420,00	344,26			
 <p>LAMO I Floor lamp Ø 40</p>	Gold Oro Gold Oro Золото	2700 °K	1812.53.2700.D***		231	1.549,00	1.269,67		
			3000 °K			1812.53.3000.D***	1.549,00	1.269,67	
		Plastic covers, Coperture plastica, Kunststoffabdeckungen, Cubiertas de plástico, Пластиковые крышки				1812.53.KIT.COVER	208,00	170,49	
		2700 °K		1816.53.2700.D***		231	1.549,00	1.269,67	
			3000 °K	1816.53.3000.D***			1.549,00	1.269,67	
	Plastic covers, Coperture plastica, Kunststoffabdeckungen, Cubiertas de plástico, Пластиковые крышки			1816.53.KIT.COVER			208,00	170,49	
	Chrome Cromo Chrom Cromo Хром	2700 °K	1817.53.2700.D***	231			1.549,00	1.269,67	
			3000 °K				1817.53.3000.D***	1.549,00	1.269,67
		Plastic covers, Coperture plastica, Kunststoffabdeckungen, Cubiertas de plástico, Пластиковые крышки					1817.53.KIT.COVER	208,00	170,49

*** Footswitch dimmer included.
Dimmer a pedale incluso.
Inklusive Fußdimmer.
Regulador de intensidad con pedal incluido.
В комплект входит диммер с ножным управлением.

* Dimmable with: Push 0-10V/1-10V/Dali / normally open button
Dimmerabile con: Push 0-10v / 1-10v/Dali / pulsante normalmente aperto
Dimmbar über: Push 0-10V / 1-10V/Dali / Taste normalerweise offen
Intensidad luminosa regulable con: Push 0-10v / 1-10v/Dali / botón normalmente abierto
Диммируется с помощью Push 0-10 V / 1-10 V/Dali / с нормально разомкнутой кнопкой

** Dimmable with: Triac
Dimmerabile con: Triac
Dimmbar über: Triac
Intensidad luminosa regulable con: Triac
Диммируется с помощью Triac

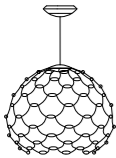
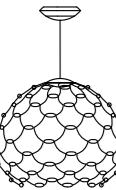
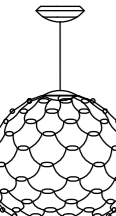
PRODUCT	FINISHES	°K	CODE	PAGE	PRICE € incl VAT (22%)	PRICE € excl VAT
 <p>LAMO I Suspension lamp Ø 40</p>	Black Nero Schwarz Negro Черный	2700 °K	1831.30.2700	215	1.091,00	894,26
			1831.30.2700.D*		1.191,00	976,23
		3000 °K	1831.30.3000		1.091,00	894,26
			1831.30.3000.D*		1.191,00	976,23
	Plastic covers, Coperture plastica, Kunststoffabdeckungen, Cubiertas de plástico, Пластиковые крышки			1831.30.KIT.COVER	208,00	170,49
 <p>LAMO I Suspension lamp Ø 60</p>	Black Nero Schwarz Negro Черный	2700 °K	1831.31.2700	215	1.398,00	1.145,90
			1831.31.2700.D*		1.498,00	1.227,87
			1831.31.2700.DT**		1.498,00	1.227,87
		3000 °K	1831.31.3000		1.398,00	1.145,90
			1831.31.3000.D*		1.498,00	1.227,87
			1831.31.3000.DT**		1.498,00	1.227,87
Plastic covers, Coperture plastica, Kunststoffabdeckungen, Cubiertas de plástico, Пластиковые крышки			1831.31.KIT.COVER	305,00	250,00	
 <p>LAMO I Suspension lamp Ø 80</p>	Black Nero Schwarz Negro Черный	2700 °K	1831.32.2700	215	1.843,00	1.510,66
			1831.32.2700.D*		1.943,00	1.592,62
		3000 °K	1831.32.3000		1.843,00	1.510,66
			1831.32.3000.D*		1.943,00	1.592,62
		Plastic covers, Coperture plastica, Kunststoffabdeckungen, Cubiertas de plástico, Пластиковые крышки			1831.32.KIT.COVER	421,00

* Dimmable with: Push 0-10V/1-10V/Dali / normally open button
Dimmerabile con: Push 0-10v / 1-10v/Dali / pulsante normalmente aperto
Dimmbar über: Push 0-10V / 1-10V/Dali / Taste normalerweise offen
Intensidad luminosa regulable con: Push 0-10v / 1-10v/Dali / botón normalmente abierto
Диммируется с помощью Push 0-10 В / 1-10 В/Dali / с нормально разомкнутой кнопкой

** Dimmable with: Triac
Dimmerabile con: Triac
Dimmbar über: Triac
Intensidad luminosa regulable con: Triac
Диммируется с помощью Triac

PRODUCT	FINISHES	°K	CODE	PAGE	PRICE € incl VAT (22%)	PRICE € excl VAT
 <p>LAMO I Ceiling lamp Ø 40</p>	Matt black Nero opaco Mattschwarz Negro mate Матовый черный	2700 °K	1831.20.2700	227	1.061,00	869,67
			1831.20.2700.D*		1.161,00	951,64
		3000 °K	1831.20.3000		1.061,00	869,67
			1831.20.3000.D*		1.161,00	951,64
	Plastic covers, Coperture plastica, Kunststoffabdeckungen, Cubiertas de plástico, Пластиковые крышки			1831.20.KIT.COVER	208,00	170,49
 <p>LAMO I Ceiling lamp Ø 60</p>	Matt black Nero opaco Mattschwarz Negro mate Матовый черный	2700 °K	1831.21.2700	227	1.368,00	1.121,31
			1831.21.2700.D*		1.468,00	1.203,28
			1831.21.2700.DT**		1.468,00	1.203,28
		3000 °K	1831.21.3000		1.368,00	1.121,31
			1831.21.3000.D*		1.468,00	1.203,28
			1831.21.3000.DT**		1.468,00	1.203,28
Plastic covers, Coperture plastica, Kunststoffabdeckungen, Cubiertas de plástico, Пластиковые крышки			1831.21.KIT.COVER	305,00	250,00	
 <p>LAMO I Ceiling lamp Ø 80</p>	Matt black Nero opaco Mattschwarz Negro mate Матовый черный	2700 °K	1831.22.2700	227	1.813,00	1.486,07
			1831.22.2700.D*		1.913,00	1.568,03
		3000 °K	1831.22.3000		1.813,00	1.486,07
			1831.22.3000.D*		1.913,00	1.568,03
		Plastic covers, Coperture plastica, Kunststoffabdeckungen, Cubiertas de plástico, Пластиковые крышки			1831.22.KIT.COVER	421,00

* Dimmable with: Push 0-10V/1-10V/Dali / normally open button
Dimmerabile con: Push 0-10v / 1-10v/Dali / pulsante normalmente aperto
Dimmbar über: Push 0-10V / 1-10V/Dali / Taste normalerweise offen
Intensidad luminosa regulable con: Push 0-10v / 1-10v/Dali / botón normalmente abierto
Диммируется с помощью Push 0-10 В / 1-10 В/Dali / с нормально разомкнутой кнопкой

** Dimmable with: Triac
Dimmerabile con: Triac
Dimmbar über: Triac
Intensidad luminosa regulable con: Triac
Диммируется с помощью Triac

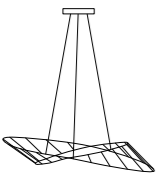
PRODUCT	FINISHES	°K	CODE	PAGE	PRICE € incl VAT (22%)	PRICE € excl VAT
 <p>TESA Suspension lamp 72x65</p>	Matt powder pink <i>Cipria opaco</i> <i>Puderrosa matt</i> <i>Rosa palo mate</i> <i>Пудровый матовый</i>	2700 °K	1837.31.2700	241	605,00	495,90
			1837.31.2700.D*		715,00	586,07
		3000 °K	1837.31.3000		605,00	495,90
			1837.31.3000.D*		715,00	586,07
	Matt copper <i>Rame opaco</i> <i>Kupfer matt</i> <i>Cobre mate</i> <i>Медный матовый</i>	2700 °K	1836.31.2700	241	605,00	495,90
			1836.31.2700.D*		715,00	586,07
		3000 °K	1836.31.3000		605,00	495,90
			1836.31.3000.D*		715,00	586,07

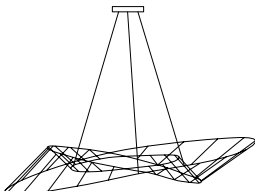
 <p>TESA Suspension lamp 120x81</p>	Matt powder pink <i>Cipria opaco</i> <i>Puderrosa matt</i> <i>Rosa palo mate</i> <i>Пудровый матовый</i>	2700 °K	1837.30.2700	241	825,00	676,23
			1837.30.2700.D*		935,00	766,39
		3000 °K	1837.30.3000		825,00	676,23
			1837.30.3000.D*		935,00	766,39
	Matt copper <i>Rame opaco</i> <i>Kupfer matt</i> <i>Cobre mate</i> <i>Медный матовый</i>	2700 °K	1836.30.2700	241	825,00	676,23
			1836.30.2700.D*		935,00	766,39
		3000 °K	1836.30.3000		825,00	676,23
			1836.30.3000.D*		935,00	766,39

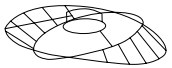
 <p>TESA Ceiling lamp</p>	Matt powder pink <i>Cipria opaco</i> <i>Puderrosa matt</i> <i>Rosa palo mate</i> <i>Пудровый матовый</i>	2700 °K	1837.21.2700	253	605,00	495,90
			1837.21.2700.D*		715,00	586,07
		3000 °K	1837.21.3000		605,00	495,90
			1837.21.3000.D*		715,00	586,07
	Matt copper <i>Rame opaco</i> <i>Kupfer matt</i> <i>Cobre mate</i> <i>Медный матовый</i>	2700 °K	1836.21.2700	253	605,00	495,90
			1836.21.2700.D*		715,00	586,07
		3000 °K	1836.21.3000		605,00	495,90
			1836.21.3000.D*		715,00	586,07

* Dimmable with: Push 0-10V/1-10V/Dali / normally open button
 Dimmerabile con: Push 0-10v / 1-10v/Dali / pulsante normalmente aperto
 Dimmbar über: Push 0-10V / 1-10V/Dali / Taste normalerweise offen
 Intensidad luminosa regulable con: Push 0-10v / 1-10v/Dali / botón normalmente abierto
 Диммируется с помощью Push 0-10 В / 1-10 В/Dali / с нормально разомкнутой кнопкой

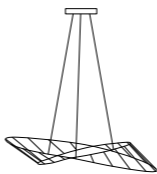
PRODUCT	FINISHES	°K	CODE	PAGE	PRICE € incl VAT (22%)	PRICE € excl VAT
 <p>TESA 2.0 Suspension lamp 72x65</p>	Matt black <i>Nero opaco</i> <i>Mattschwarz</i> <i>Negro mate</i> <i>Матовый черный</i>	2700 °K	1838.31.2700	263	605,00	495,90
			1838.31.2700.D*		715,00	586,07
		3000 °K	1838.31.3000		605,00	495,90
			1838.31.3000.D*		715,00	586,07

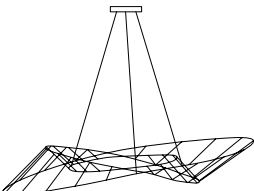
 <p>TESA 2.0 Suspension lamp 120x81</p>	Matt black <i>Nero opaco</i> <i>Mattschwarz</i> <i>Negro mate</i> <i>Матовый черный</i>	2700 °K	1838.30.2700	263	825,00	676,23
			1838.30.2700.D*		935,00	766,39
		3000 °K	1838.30.3000		825,00	676,23
			1838.30.3000.D*		935,00	766,39

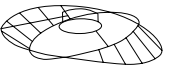
 <p>TESA 2.0 Ceiling lamp</p>	Matt black <i>Nero opaco</i> <i>Mattschwarz</i> <i>Negro mate</i> <i>Матовый черный</i>	2700 °K	1838.21.2700	269	605,00	495,90
			1838.21.2700.D*		715,00	586,07
		3000 °K	1838.21.3000		605,00	495,90
			1838.21.3000.D*		715,00	586,07

* Dimmable with: Push 0-10V/1-10V/Dali / normally open button
 Dimmerabile con: Push 0-10v / 1-10v/Dali / pulsante normalmente aperto
 Dimmbar über: Push 0-10V / 1-10V/Dali / Taste normalerweise offen
 Intensidad luminosa regulable con: Push 0-10v / 1-10v/Dali / botón normalmente abierto
 Диммируется с помощью Push 0-10 В / 1-10 В/Dali / с нормально разомкнутой кнопкой

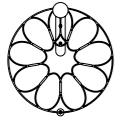
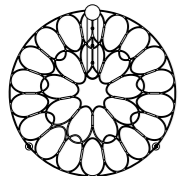
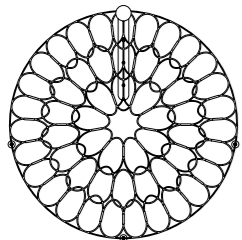
PRODUCT	FINISHES	°K	CODE	PAGE	PRICE € incl VAT (22%)	PRICE € excl VAT
 LAFRA Ceiling lamp Ø 45	Chrome Cromo Chrom Cromo Хром	2700 °K	1833.21.2700	283	394,00	322,95
			1833.21.2700.DP*		429,00	351,64
		3000 °K	1833.21.3000		394,00	322,95
			1833.21.3000.DP*		429,00	351,64
	Plastic covers, <i>Coperture plastica, Kunststoffabdeckungen, Cubiertas de plástico, Пластиковые крышки</i>			1833.21.KIT.COVER	36,00	29,51
 LAFRA Ceiling lamp Ø 70	Chrome Cromo Chrom Cromo Хром	2700 °K	1833.22.2700	283	667,00	546,72
			1833.22.2700.DP*		706,00	578,69
		3000 °K	1833.22.3000		667,00	546,72
			1833.22.3000.DP*		706,00	578,69
	Plastic covers, <i>Coperture plastica, Kunststoffabdeckungen, Cubiertas de plástico, Пластиковые крышки</i>			1833.22.KIT.COVER	105,00	86,07
 LAFRA Ceiling lamp Ø 95	Chrome Cromo Chrom Cromo Хром	2700 °K	1833.23.2700	283	1.011,00	828,69
			1833.23.2700.DP*		1.046,00	857,38
		3000 °K	1833.23.3000		1.011,00	828,69
			1833.23.3000.DP*		1.046,00	857,38
	Plastic covers, <i>Coperture plastica, Kunststoffabdeckungen, Cubiertas de plástico, Пластиковые крышки</i>			1833.23.KIT.COVER	208,00	170,49

* Dimmable with Push
 Dimmerabile con Push
 Dimmbar über Push
 Intensidad luminosa regulable con Push
 Диммируется с помощью Push

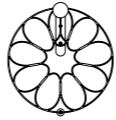
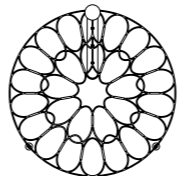
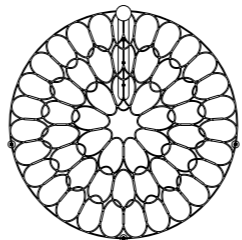
PRODUCT	FINISHES	°K	CODE	PAGE	PRICE € incl VAT (22%)	PRICE € excl VAT
 LAFRA Wall lamp Ø 45	Chrome Cromo Chrom Cromo Хром	2700 °K	1833.11.2700	293	388,00	318,03
			1833.11.2700.DP*		417,00	341,80
		3000 °K	1833.11.3000		388,00	318,03
			1833.11.3000.DP*		417,00	341,80
	Plastic covers, <i>Coperture plastica, Kunststoffabdeckungen, Cubiertas de plástico, Пластиковые крышки</i>			1833.11.KIT.COVER	36,00	29,51
 LAFRA Wall lamp Ø 70	Chrome Cromo Chrom Cromo Хром	2700 °K	1833.12.2700	293	655,00	536,89
			1833.12.2700.DP*		694,00	568,85
		3000 °K	1833.12.3000		655,00	536,89
			1833.12.3000.DP*		694,00	568,85
	Plastic covers, <i>Coperture plastica, Kunststoffabdeckungen, Cubiertas de plástico, Пластиковые крышки</i>			1833.12.KIT.COVER	105,00	86,07
 LAFRA Wall lamp Ø 95	Chrome Cromo Chrom Cromo Хром	2700 °K	1833.13.2700	293	999,00	818,85
			1833.13.2700.DP*		1.034,00	847,54
		3000 °K	1833.13.3000		999,00	818,85
			1833.13.3000.DP*		1.034,00	847,54
	Plastic covers, <i>Coperture plastica, Kunststoffabdeckungen, Cubiertas de plástico, Пластиковые крышки</i>			1833.13.KIT.COVER	208,00	170,49

* Dimmable with Push
 Dimmerabile con Push
 Dimmbar über Push
 Intensidad luminosa regulable con Push
 Диммируется с помощью Push

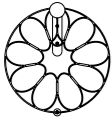
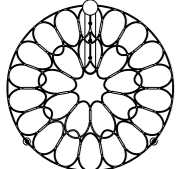
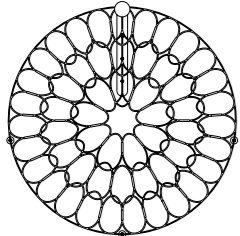
PRODUCT	FINISHES	°K	CODE	PAGE	PRICE € incl VAT (22%)	PRICE € excl VAT
 <p>LAFRA Ceiling lamp Ø 45</p>	Matt black Nero opaco Mattschwarz Negro mate Матовый черный	2700 °K	1834.21.2700	283	394,00	322,95
			1834.21.2700.DP*		429,00	351,64
		3000 °K	1834.21.3000		394,00	322,95
			1834.21.3000.DP*		429,00	351,64
	Plastic covers, Coperture plastica, Kunststoffabdeckungen, Cubiertas de plástico, Пластиковые крышки			1834.21.KIT.COVER		36,00
 <p>LAFRA Ceiling lamp Ø 70</p>	Matt black Nero opaco Mattschwarz Negro mate Матовый черный	2700 °K	1834.22.2700	283	667,00	546,72
			1834.22.2700.DP*		706,00	578,69
		3000 °K	1834.22.3000		667,00	546,72
			1834.22.3000.DP*		706,00	578,69
	Plastic covers, Coperture plastica, Kunststoffabdeckungen, Cubiertas de plástico, Пластиковые крышки			1834.22.KIT.COVER		105,00
 <p>LAFRA Ceiling lamp Ø 95</p>	Matt black Nero opaco Mattschwarz Negro mate Матовый черный	2700 °K	1834.23.2700	283	1.011,00	828,69
			1834.23.2700.DP*		1.046,00	857,38
		3000 °K	1834.23.3000		1.011,00	828,69
			1834.23.3000.DP*		1.046,00	857,38
	Plastic covers, Coperture plastica, Kunststoffabdeckungen, Cubiertas de plástico, Пластиковые крышки			1834.23.KIT.COVER		208,00

* Dimmable with Push
Dimmerabile con Push
Dimmbar über Push
Intensidad luminosa regulable con Push
Диммируется с помощью Push

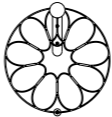
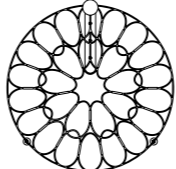
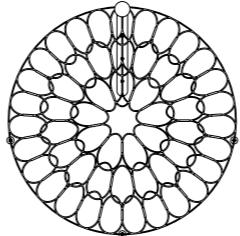
PRODUCT	FINISHES	°K	CODE	PAGE	PRICE € incl VAT (22%)	PRICE € excl VAT
 <p>LAFRA Wall lamp Ø 45</p>	Matt black Nero opaco Mattschwarz Negro mate Матовый черный	2700 °K	1834.11.2700	293	388,00	318,03
			1834.11.2700.DP*		417,00	341,80
		3000 °K	1834.11.3000		388,00	318,03
			1834.11.3000.DP*		417,00	341,80
	Plastic covers, Coperture plastica, Kunststoffabdeckungen, Cubiertas de plástico, Пластиковые крышки			1834.11.KIT.COVER		36,00
 <p>LAFRA Wall lamp Ø 70</p>	Matt black Nero opaco Mattschwarz Negro mate Матовый черный	2700 °K	1834.12.2700	293	655,00	536,89
			1834.12.2700.DP*		694,00	568,85
		3000 °K	1834.12.3000		655,00	536,89
			1834.12.3000.DP*		694,00	568,85
	Plastic covers, Coperture plastica, Kunststoffabdeckungen, Cubiertas de plástico, Пластиковые крышки			1834.12.KIT.COVER		105,00
 <p>LAFRA Wall lamp Ø 95</p>	Matt black Nero opaco Mattschwarz Negro mate Матовый черный	2700 °K	1834.13.2700	293	999,00	818,85
			1834.13.2700.DP*		1.034,00	847,54
		3000 °K	1834.13.3000		999,00	818,85
			1834.13.3000.DP*		1.034,00	847,54
	Plastic covers, Coperture plastica, Kunststoffabdeckungen, Cubiertas de plástico, Пластиковые крышки			1834.13.KIT.COVER		208,00

* Dimmable with Push
Dimmerabile con Push
Dimmbar über Push
Intensidad luminosa regulable con Push
Диммируется с помощью Push

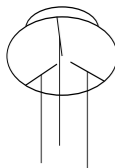
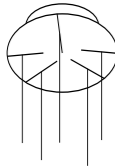
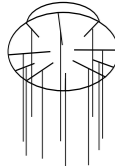
PRODUCT	FINISHES	CODE	PAGE	PRICE incl VAT (22%)	PRICE excl VAT
 BEBA Ceiling canopy	One-light ceiling canopy <i>Montatura 1 luce</i> <i>Baldachin 1 Leuchte</i> <i>Rosetón 1 luz</i> <i>Рамка с 1 светоэлементом</i>	1730.M.30	313	74,00	60,66
 BEBA Ceiling canopy	Three-lights round ceiling canopy <i>Montatura tonda 3 luci Kit</i> <i>Runder Baldachin 3 Leuchten-Set</i> <i>Rosetón redondo 3 luces</i> <i>Круглая рамка с 3 светоэлементами</i>	1730.M.34	313	270,00	221,31
 BEBA Ceiling canopy	Five-lights round ceiling canopy <i>Montatura tonda 5 luci Kit</i> <i>Runder Baldachin 5 Leuchten-Set</i> <i>Rosetón redondo 5 luces</i> <i>Круглая рамка с 5 светоэлементами</i>	1730.M.35	313	420,00	344,26
 BEBA Ceiling canopy	Ten-lights round ceiling canopy <i>Montatura tonda 10 luci Kit</i> <i>Runder Baldachin 10 Leuchten-Set</i> <i>Rosetón redondo 10 luces</i> <i>Круглая рамка с 10 светоэлементами</i>	1730.M.36	313	894,00	732,79

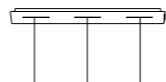
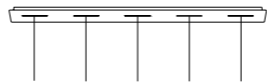
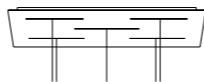
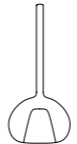
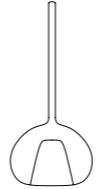
PRODUCT	FINISHES	CODE	PAGE	PRICE € incl VAT (22%)	PRICE € excl VAT
 BEBA Ceiling canopy	Three-light linear ceiling canopy with cables and lamp holder <i>Montatura lineare 3 luci con cavi e portalampada</i> <i>Linearer Baldachin 3 Leuchten mit Kabeln und Lampenfassung</i> <i>Rosetón lineal 3 luces con cables y portalámparas</i> <i>Линейная рамка с 3 светоэлементами</i> <i>с кабелями и держателем лампы</i>	1730.M.40	313	210,00	172,13
 BEBA Ceiling canopy	Five-light linear ceiling canopy with cables and lamp holder <i>Montatura lineare 5 luci con cavi e portalampada</i> <i>Linearer Baldachin 5 Leuchten mit Kabeln und Lampenfassung</i> <i>Rosetón lineal 5 luces con cables y portalámparas</i> <i>Линейная рамка с 5 светоэлементами</i> <i>с кабелями и держателем лампы</i>	1730.M.41	313	327,00	268,03
 BEBA Ceiling canopy	Five-light rectangular ceiling canopy with cables and lamp holder <i>Montatura rettangolare 5 luci con cavi e portalampada</i> <i>Rechteckiger Baldachin 5 Leuchten mit Kabeln und Lampenfassung</i> <i>Rosetón rectangular 5 luces con cables y portalámparas</i> <i>Прямоугольная рамка с 5 светоэлементами</i> <i>с кабелями и держателем лампы</i>	1730.M.42	313	423,00	346,72
 BEBA Glass 15 x 35	Trasparent <i>Trasparente</i> Transparent <i>Transparente</i> Прозрачный	1730.V.TR	313	74,00	60,66
	Chrome <i>Crómo</i> Chrom <i>Crómo</i> Хром	1730.V.CR		108,00	88,52
	Bronze <i>Bronzo</i> Bronze <i>Bronce</i> Бронза	1730.V.BZ		108,00	88,52
	Gold <i>Oro</i> Gold <i>Oro</i> Золото	1730.V.GOLD		108,00	88,52
 BEBA Glass 20 x 45	Trasparent <i>Trasparente</i> Transparent <i>Transparente</i> Прозрачный	1730.V.BIG.TR	313	155,00	127,05
	Chrome <i>Crómo</i> Chrom <i>Crómo</i> Хром	1730.V.BIG.CR		161,00	131,97
	Bronze <i>Bronzo</i> Bronze <i>Bronce</i> Бронза	1730.V.BIG.BZ		161,00	131,97
	Gold <i>Oro</i> Gold <i>Oro</i> Золото	1730.V.BIG.GOLD		161,00	131,97



U14

urbanlighting.it

Headquarter / Showroom
Viale Dell'Industria, 21
20037 Paderno Dugnano (MI) Italia
T. +39 02 9104958
T. +39 02 9105178
info@sforzinilluminazione.com