



**URBAN**<sup>®</sup>  
L I G H T I N G

**U14.2**



**URBAN**<sup>®</sup>  
L I G H T I N G



Discover more



# **PRICE LIST**

LISTINO PREZZI

PREISLISTE

LISTA DE PRECIOS

ПРАЙС-ЛИСТ

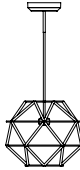
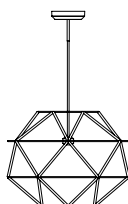
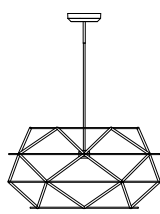
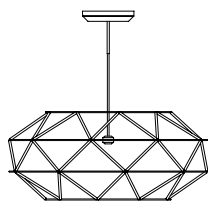
PRODUCT	FINISHES	°K	CODE	PAGE	PRICE € incl VAT (22%)	PRICE € excl VAT	
 <p><b>EUCLIDE</b> Suspension lamp 350</p>	Matt black <i>Nero opaco</i> Mattschwarz <i>Negro mate</i> Матовый черный	2700 °K	1821.30.2700	23	1.106,00	906,56	
					1821.30.2700.DP***	1.143,00	936,89
		3000 °K	1821.30.3000		1.106,00	906,56	
					1821.30.3000.DP***	1.143,00	936,89
	Gold <i>Oro</i> Gold <i>Oro</i> Золото	2700 °K	1822.30.2700	23	1.106,00	906,56	
					1822.30.2700.DP***	1.143,00	936,89
		3000 °K	1822.30.3000		1.106,00	906,56	
					1822.30.3000.DP***	1.143,00	936,89
 <p><b>EUCLIDE</b> Suspension lamp 560</p>	Matt black <i>Nero opaco</i> Mattschwarz <i>Negro mate</i> Матовый черный	2700 °K	1821.31.2700	23	1.483,00	1.215,57	
					1821.31.2700.D*	1.520,00	1.245,90
					1821.31.2700.DT**	1.520,00	1.245,90
		3000 °K	1821.31.3000		1.483,00	1.215,57	
					1821.31.3000.D*	1.520,00	1.245,90
					1821.31.3000.DT**	1.520,00	1.245,90
	Gold <i>Oro</i> Gold <i>Oro</i> Золото	2700 °K	1822.31.2700	23	1.483,00	1.215,57	
					1822.31.2700.D*	1.520,00	1.245,90
					1822.31.2700.DT**	1.520,00	1.245,90
		3000 °K	1822.31.3000		1.483,00	1.215,57	
		1822.31.3000.D*	1.520,00	1.245,90			
		1822.31.3000.DT**	1.520,00	1.245,90			
 <p><b>EUCLIDE</b> Suspension lamp 700</p>	Matt black <i>Nero opaco</i> Mattschwarz <i>Negro mate</i> Матовый черный	2700 °K	1821.32.2700	23	1.628,00	1.334,43	
					1821.32.2700.D*	1.665,00	1.364,75
					1821.32.2700.DT**	1.665,00	1.364,75
		3000 °K	1821.32.3000		1.628,00	1.334,43	
					1821.32.3000.D*	1.665,00	1.364,75
					1821.32.3000.DT**	1.665,00	1.364,75
	Gold <i>Oro</i> Gold <i>Oro</i> Золото	2700 °K	1822.32.2700	23	1.628,00	1.334,43	
					1822.32.2700.D*	1.665,00	1.364,75
					1822.32.2700.DT**	1.665,00	1.364,75
		3000 °K	1822.32.3000		1.628,00	1.334,43	
		1822.32.3000.D*	1.665,00	1.364,75			
		1822.32.3000.DT**	1.665,00	1.364,75			
 <p><b>EUCLIDE</b> Suspension lamp 920</p>	Matt black <i>Nero opaco</i> Mattschwarz <i>Negro mate</i> Матовый черный	2700 °K	1821.33.2700	23	2.078,00	1.703,28	
					1821.33.2700.D*	2.115,00	1.733,61
					1821.33.2700.DT**	2.115,00	1.733,61
		3000 °K	1821.33.3000		2.078,00	1.703,28	
					1821.33.3000.D*	2.115,00	1.733,61
					1821.33.3000.DT**	2.115,00	1.733,61
	Gold <i>Oro</i> Gold <i>Oro</i> Золото	2700 °K	1822.33.2700	23	2.078,00	1.703,28	
					1822.33.2700.D*	2.115,00	1.733,61
					1822.33.2700.DT**	2.115,00	1.733,61
		3000 °K	1822.33.3000		2.078,00	1.703,28	
		1822.33.3000.D*	2.115,00	1.733,61			
		1822.33.3000.DT**	2.115,00	1.733,61			

\* Dimmable with: PUSH 0-10V/1-10V/DALI / normally open button  
 Dimmerabile con: PUSH 0-10v / 1-10v/DALI / pulsante normalmente aperto  
 Dimmbar über: PUSH 0-10V / 1-10V/DALI / Taste normalerweise offen  
 Intensidad luminosa regulable con: PUSH 0-10v / 1-10v/DALI / botón normalmente abierto  
 Диммируется с помощью PUSH 0-10 В / 1-10 В /DALI / с нормально разомкнутой кнопкой

\*\* Dimmable with: TRIAC  
 Dimmerabile con: TRIAC  
 Dimmbar über: TRIAC  
 Intensidad luminosa regulable con: TRIAC  
 Диммируется с помощью TRIAC

\*\*\* Dimmable with: PUSH  
 Dimmerabile con: PUSH  
 Dimmbar über: PUSH  
 Intensidad luminosa regulable con: PUSH  
 Диммируется с помощью PUSH

PRICE LIST \_ EUCLIDE

PRODUCT	FINISHES	°K	CODE	PAGE	PRICE € incl VAT (22%)	PRICE € excl VAT
 <b>EUCLIDE</b> Ceiling lamp 350	Matt black Nero opaco Mattschwarz Negro mate Матовый черный	2700 °K	1821.20.2700	33	1.106,00	906,56
			1821.20.2700.DP***		1.212,00	993,44
		3000 °K	1821.20.3000		1.106,00	906,56
			1821.20.3000.DP***		1.212,00	993,44
	Gold Oro Gold Oro Золото	2700 °K	1822.20.2700	33	1.106,00	906,56
			1822.20.2700.DP***		1.212,00	993,44
		3000 °K	1822.20.3000		1.106,00	906,56
			1822.20.3000.DP***		1.212,00	993,44
 <b>EUCLIDE</b> Ceiling lamp 560	Matt black Nero opaco Mattschwarz Negro mate Матовый черный	2700 °K	1821.21.2700	33	1.483,00	1.215,57
			1821.21.2700.D*		1.520,00	1.245,90
			1821.21.2700.DT**		1.520,00	1.245,90
		3000 °K	1821.21.3000		1.483,00	1.215,57
			1821.21.3000.D*		1.520,00	1.245,90
			1821.21.3000.DT**		1.520,00	1.245,90
	Gold Oro Gold Oro Золото	2700 °K	1822.21.2700	33	1.483,00	1.215,57
			1822.21.2700.D*		1.520,00	1.245,90
			1822.21.2700.DT**		1.520,00	1.245,90
		3000 °K	1822.21.3000		1.483,00	1.215,57
			1822.21.3000.D*		1.520,00	1.245,90
			1822.21.3000.DT**		1.520,00	1.245,90
 <b>EUCLIDE</b> Ceiling lamp 700	Matt black Nero opaco Mattschwarz Negro mate Матовый черный	2700 °K	1821.22.2700	33	1.628,00	1.334,43
			1821.22.2700.D*		1.665,00	1.364,75
			1821.22.2700.DT**		1.665,00	1.364,75
		3000 °K	1821.22.3000		1.628,00	1.334,43
			1821.22.3000.D*		1.665,00	1.364,75
			1821.22.3000.DT**		1.665,00	1.364,75
	Gold Oro Gold Oro Золото	2700 °K	1822.22.2700	33	1.628,00	1.334,43
			1822.22.2700.D*		1.665,00	1.364,75
			1822.22.2700.DT**		1.665,00	1.364,75
		3000 °K	1822.22.3000		1.628,00	1.334,43
			1822.22.3000.D*		1.665,00	1.364,75
			1822.22.3000.DT**		1.665,00	1.364,75
 <b>EUCLIDE</b> Ceiling lamp 920	Matt black Nero opaco Mattschwarz Negro mate Матовый черный	2700 °K	1821.23.2700	33	2.078,00	1.703,28
			1821.23.2700.D*		2.115,00	1.733,61
			1821.23.2700.DT**		2.115,00	1.733,61
		3000 °K	1821.23.3000		2.078,00	1.703,28
			1821.23.3000.D*		2.115,00	1.733,61
			1821.23.3000.DT**		2.115,00	1.733,61
	Gold Oro Gold Oro Золото	2700 °K	1822.23.2700	33	2.078,00	1.703,28
			1822.23.2700.D*		2.115,00	1.733,61
			1822.23.2700.DT**		2.115,00	1.733,61
		3000 °K	1822.23.3000		2.078,00	1.703,28
			1822.23.3000.D*		2.115,00	1.733,61
			1822.23.3000.DT**		2.115,00	1.733,61

\* Dimmable with: PUSH 0-10V/1-10V/DALI / normally open button  
 Dimmerabile con: PUSH 0-10v / 1-10v/DALI / pulsante normalmente aperto  
 Dimmbar über: PUSH 0-10V / 1-10V/DALI / Taste normalerweise offen  
 Intensidad luminosa regulable con: PUSH 0-10v / 1-10v/DALI / botón normalmente abierto  
 Диммируется с помощью PUSH 0-10 В / 1-10 В/DALI / с нормально разомкнутой кнопкой

\*\* Dimmable with: TRIAC  
 Dimmerabile con: TRIAC  
 Dimmbar über: TRIAC  
 Intensidad luminosa regulable con: TRIAC  
 Диммируется с помощью TRIAC



\*\*\* Dimmable with: PUSH  
 Dimmerabile con: PUSH  
 Dimmbar über: PUSH  
 Intensidad luminosa regulable con: PUSH  
 Диммируется с помощью PUSH

PRICE LIST \_ E U C L I D E

PRODUCT	FINISHES	°K	CODE	PAGE	PRICE € incl VAT (22%)	PRICE € excl VAT
 <p><b>EUCLIDE Wall</b></p>	Matt black <i>Nero opaco</i> <i>Mattschwarz</i> <i>Negro mate</i> <i>Матовый черный</i>	2700 °K	<b>1821.10.2700</b>	39	<b>776,00</b>	<b>636,07</b>
		3000 °K	<b>1821.10.3000</b>		<b>776,00</b>	<b>636,07</b>
	Gold <i>Oro</i> <i>Gold</i> <i>Oro</i> <i>Золото</i>	2700 °K	<b>1822.10.2700</b>	39	<b>776,00</b>	<b>636,07</b>
		3000 °K	<b>1822.10.3000</b>		<b>776,00</b>	<b>636,07</b>
 <p><b>EUCLIDE Floor</b></p>	Matt black <i>Nero opaco</i> <i>Mattschwarz</i> <i>Negro mate</i> <i>Матовый черный</i>	2700 °K	<b>1821.50.2700.D***</b>	43	<b>1.749,00</b>	<b>1.433,61</b>
		3000 °K	<b>1821.50.3000.D***</b>		<b>1.749,00</b>	<b>1.433,61</b>
		2700 °K	<b>1821.51.2700.D***</b>	-	<b>1.399,00</b>	<b>1.146,72</b>
	Gold <i>Oro</i> <i>Gold</i> <i>Oro</i> <i>Золото</i>	2700 °K	<b>1822.50.2700.D***</b>	43	<b>1.749,00</b>	<b>1.433,61</b>
3000 °K		<b>1822.50.3000.D***</b>	<b>1.749,00</b>		<b>1.433,61</b>	

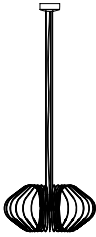

\*\*\* Footswitch dimmer included.  
*Dimmer a pedale incluso.*  
*Inklusive Fußdimmer.*  
*Regulador de intensidad con pedal incluido.*  
*В комплект входит диммер с ножным управлением.*

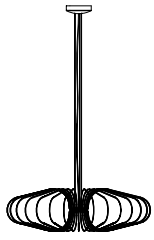
PRICE LIST \_ F I L O

PRODUCT	FINISHES	°K	CODE	PAGE	PRICE € incl VAT (22%)	PRICE € excl VAT	
 <p><b>FILO</b> Suspension Ø 50</p>	Matt powder pink <i>Cipria opaco</i> Puderrosa matt Rosa palo mate Пудровый матовый	2700 °K	1839.30.2700	57	1.805,00	1.479,51	
			1839.30.2700.D*		1.911,00	1.566,39	
		3000 °K	1839.30.3000		1.805,00	1.479,51	
			1839.30.3000.D*		1.911,00	1.566,39	
	Titanium <i>Titanio</i> Titan Titanio Титан	2700 °K	1840.30.2700	57	1.805,00	1.479,51	
			1840.30.2700.D*		1.911,00	1.566,39	
		3000 °K	1840.30.3000		1.805,00	1.479,51	
			1840.30.3000.D*		1.911,00	1.566,39	
 <p><b>FILO</b> Suspension Ø 70</p>	Matt powder pink <i>Cipria opaco</i> Puderrosa matt Rosa palo mate Пудровый матовый	2700 °K	1839.31.2700	57	2.180,00	1.786,89	
			1839.31.2700.D*		2.286,00	1.873,77	
		3000 °K	1839.31.3000		2.180,00	1.786,89	
			1839.31.3000.D*		2.286,00	1.873,77	
	Titanium <i>Titanio</i> Titan Titanio Титан	2700 °K	1840.31.2700	57	2.180,00	1.786,89	
			1840.31.2700.D*		2.286,00	1.873,77	
		3000 °K	1840.31.3000		2.180,00	1.786,89	
			1840.31.3000.D*		2.286,00	1.873,77	
 <p><b>FILO</b> Suspension Ø 90</p>	Matt powder pink <i>Cipria opaco</i> Puderrosa matt Rosa palo mate Пудровый матовый	2700 °K	1839.32.2700	57	2.635,00	2.159,84	
			1839.32.2700.D*		2.741,00	2.246,72	
			1839.32.2700.DT**		2.741,00	2.246,72	
		3000 °K	1839.32.3000		2.635,00	2.159,84	
			1839.32.3000.D*		2.741,00	2.246,72	
			1839.32.3000.DT**		2.741,00	2.246,72	
	Titanium <i>Titanio</i> Titan Titanio Титан	2700 °K	1840.32.2700		57	2.635,00	2.159,84
			1840.32.2700.D*			2.741,00	2.246,72
			1840.32.2700.DT**			2.741,00	2.246,72
		3000 °K	1840.32.3000			2.635,00	2.159,84
			1840.32.3000.D*			2.741,00	2.246,72
			1840.32.3000.DT**			2.741,00	2.246,72
 <p><b>FILO</b> Suspension Ø 110</p>	Matt powder pink <i>Cipria opaco</i> Puderrosa matt Rosa palo mate Пудровый матовый	2700 °K	1839.33.2700	57		3.262,00	2.673,77
			1839.33.2700.D*			3.368,00	2.760,66
			1839.33.2700.DT**			3.368,00	2.760,66
		3000 °K	1839.33.3000			3.262,00	2.673,77
			1839.33.3000.D*			3.368,00	2.760,66
			1839.33.3000.DT**			3.368,00	2.760,66
	Titanium <i>Titanio</i> Titan Titanio Титан	2700 °K	1840.33.2700		57	3.262,00	2.673,77
			1840.33.2700.D*			3.368,00	2.760,66
			1840.33.2700.DT**			3.368,00	2.760,66
		3000 °K	1840.33.3000			3.262,00	2.673,77
			1840.33.3000.D*			3.368,00	2.760,66
			1840.33.3000.DT**			3.368,00	2.760,66

\* Dimmable with: PUSH 0-10V/1-10V/DALI / normally open button  
 Dimmerabile con: PUSH 0-10v / 1-10v/DALI / pulsante normalmente aperto  
 Dimmbar über: PUSH 0-10V / 1-10V/DALI / Taste normalerweise offen  
 Intensidad luminosa regulable con: PUSH 0-10v / 1-10v/DALI / botón normalmente abierta  
 Диммируется с помощью PUSH 0-10 В / 1-10 В/DALI / с нормально разомкнутой кнопкой

\*\* Dimmable with: TRIAC  
 Dimmerabile con: TRIAC  
 Dimmbar über: TRIAC  
 Intensidad luminosa regulable con: TRIAC  
 Диммируется с помощью TRIAC

PRODUCT	FINISHES	°K	CODE	PAGE	PRICE € incl VAT (22%)	PRICE € excl VAT
 <p><b>FILO</b> Ceiling lamp Ø 50</p>	Matt powder pink <i>Cipria opaco</i> Puderrosa matt Rosa palo mate Пудровый матовый	2700 °K	1839.20.2700	65	1.774,00	1.454,10
			1839.20.2700.D*		1.880,00	1.540,98
			1839.20.2700.DT**		1.880,00	1.540,98
		3000 °K	1839.20.3000		1.774,00	1.454,10
			1839.20.3000.D*		1.880,00	1.540,98
			1839.20.3000.DT**		1.880,00	1.540,98
	Titanium <i>Titanio</i> Titan Titanio Титан	2700 °K	1840.20.2700	65	1.774,00	1.454,10
			1840.20.2700.D*		1.880,00	1.540,98
			1840.20.2700.DT**		1.880,00	1.540,98
		3000 °K	1840.20.3000		1.774,00	1.454,10
			1840.20.3000.D*		1.880,00	1.540,98
			1840.20.3000.DT**		1.880,00	1.540,98
 <p><b>FILO</b> Ceiling lamp Ø 80</p>	Matt powder pink <i>Cipria opaco</i> Puderrosa matt Rosa palo mate Пудровый матовый	2700 °K	1839.21.2700	65	1.835,00	1.504,10
			1839.21.2700.D*		1.941,00	1.590,98
			1839.21.2700.DT**		1.941,00	1.590,98
		3000 °K	1839.21.3000		1.835,00	1.504,10
			1839.21.3000.D*		1.941,00	1.590,98
			1839.21.3000.DT**		1.941,00	1.590,98
	Titanium <i>Titanio</i> Titan Titanio Титан	2700 °K	1840.21.2700	65	1.835,00	1.504,10
			1840.21.2700.D*		1.941,00	1.590,98
			1840.21.2700.DT**		1.941,00	1.590,98
		3000 °K	1840.21.3000		1.835,00	1.504,10
			1840.21.3000.D*		1.941,00	1.590,98
			1840.21.3000.DT**		1.941,00	1.590,98
 <p><b>FILO</b> Ceiling lamp Ø 100</p>	Matt powder pink <i>Cipria opaco</i> Puderrosa matt Rosa palo mate Пудровый матовый	2700 °K	1839.22.2700	65	2.255,00	1.848,36
			1839.22.2700.D*		2.361,00	1.935,25
			1839.22.2700.DT**		2.361,00	1.935,25
		3000 °K	1839.22.3000		2.255,00	1.848,36
			1839.22.3000.D*		2.361,00	1.935,25
			1839.22.3000.DT**		2.361,00	1.935,25
	Titanium <i>Titanio</i> Titan Titanio Титан	2700 °K	1840.22.2700	65	2.255,00	1.848,36
			1840.22.2700.D*		2.361,00	1.935,25
			1840.22.2700.DT**		2.361,00	1.935,25
		3000 °K	1840.22.3000		2.255,00	1.848,36
			1840.22.3000.D*		2.361,00	1.935,25
			1840.22.3000.DT**		2.361,00	1.935,25

\* Dimmable with: PUSH 0-10V/1-10V/DALI / normally open button  
 Dimmerabile con: PUSH 0-10v / 1-10v/DALI / pulsante normalmente aperto  
 Dimmbar über: PUSH 0-10V / 1-10V/DALI / Taste normalerweise offen  
 Intensidad luminosa regulable con: PUSH 0-10v / 1-10v/DALI / botón normalmente abierta  
 Диммируется с помощью PUSH 0-10 В / 1-10 В/DALI / с нормально разомкнутой кнопкой

\*\* Dimmable with: TRIAC  
 Dimmerabile con: TRIAC  
 Dimmbar über: TRIAC  
 Intensidad luminosa regulable con: TRIAC  
 Диммируется с помощью TRIAC

## Surface mounting - Suspension

Luminaire / Corpo illuminante / Beleuchtungskörper / Luminaria / Светильник

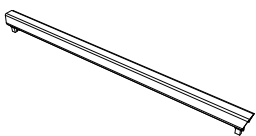
PRODUCT	FINISHES	CM.	W	°K	LUMEN	CODE	PAGE	PRICE € incl VAT (22%)	PRICE € excl VAT
 <p><b>CARTESIAN</b> Surface Mounting</p>	Light module Modulo luce Lichtmodul Módulo de luz Световой модуль  24V - CRI 90	30	5W	2700 °K	400	<b>1832.2.2700</b>	78	<b>52,00</b>	<b>42,62</b>
				3000 °K	500	<b>1832.2.3000</b>	78	<b>52,00</b>	<b>42,62</b>
		60	10W	2700 °K	800	<b>1832.3.2700</b>	78	<b>63,00</b>	<b>51,64</b>
				3000 °K	1000	<b>1832.3.3000</b>	78	<b>63,00</b>	<b>51,64</b>
		90	15W	2700 °K	1200	<b>1832.4.2700</b>	78	<b>73,00</b>	<b>59,84</b>
				3000 °K	1500	<b>1832.4.3000</b>	78	<b>73,00</b>	<b>59,84</b>
		120	20W	2700 °K	1600	<b>1832.5.2700</b>	78	<b>84,00</b>	<b>68,85</b>
				3000 °K	2000	<b>1832.5.3000</b>	78	<b>84,00</b>	<b>68,85</b>

## Accessories

Ceiling canopies and driver / Driver e rosoni / Baldachine und Driver / Rosetones y controladores / Потолочные чашки и драйверы

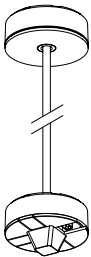
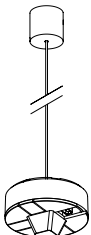
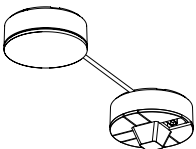
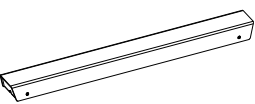
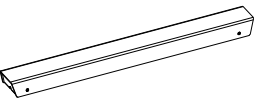
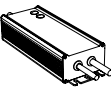
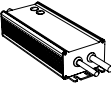
ACCESSORIES	W	CODE	PRICE € incl VAT (22%)	PRICE € excl VAT
 Cartesian system connection base <i>Basetta di collegamento per sistema Cartesian</i> <i>Anschlusssockel für das System Cartesian</i> <i>Placa de conexión para sistema cartesiano</i> <i>Основание для подключения для системы Cartesian</i>		1832.1	41,00	33,61
 Ceiling canopy with power cable <i>Rosone soffitto con cavo di alimentazione</i> <i>Deckenbaldachin mit Stromkabel</i> <i>Rosetón de techo con cable de alimentación</i> <i>Потолочная чашка с проводом</i>		1832.12	111,00	90,98
 Steel ceiling cable kit <i>Kit cavo acciaio soffitto</i> <i>Deckenkabel-Set aus Stahl</i> <i>Kit cable de acero para techo</i> <i>Комплект потолочного крепежа из стали</i>		1832.13	84,00	68,85
 Remote driver ceiling canopy <i>Rosone driver remoto</i> <i>Baldachin ferngesteuerter Driver</i> <i>Rosetón controlador remoto</i> <i>Потолочная чашка с выносным драйвером</i>		1832.14	52,00	42,62
 Built-in power supply <i>Alimentatore a bordo</i> <i>Integrierte Stromversorgung</i> <i>Fuente de alimentación integrada</i> <i>Встроенный блок питания</i>	60W	1832.6	189,00	154,92
	100W	1832.7	233,00	190,98
	200W	1832.8	326,00	267,21
 DALI dimmable PUSH built-in power supply (0-10v, 1-10v) <i>Alimentatore a bordo dimmerabile PUSH, DALI, 0-10v, 1-10v</i> <i>Integrierte Stromversorgung on board dimmbar PUSH, DALI, 0-10v, 1-10v</i> <i>Fuente de alimentación integrada, intensidad luminosa regulable PUSH, DALI, 0-10v, 1-10v</i> <i>Диммируемый встроенный блок питания с функцией PUSH и управлением DALI, 0-10 В, 1-10 В</i>	60W Dimmer	1832.9	320,00	262,30
	100W Dimmer	1832.10	366,00	300,00
	200W Dimmer	1832.11	459,00	376,23
 Remote ON/OFF power supply <i>Alimentatore remoto On-Off</i> <i>Fernbedienbare Ein-Aus-Stromversorgung</i> <i>Fuente de alimentación remota On-Off</i> <i>Блок дистанционного питания Вкл.-Выкл.</i>	50W	T73.50W.24.SNP	61,00	50,00
	100W	T73.100W.24.SNP	114,00	93,44
	150W	T73.150W.24.SNP	108,00	88,52
	200W	T73.200W.24.SNP	173,00	141,80
	320W	T73.320W.24.SNP	251,00	205,74
 Dimmable remote power supply (1-10v). <i>Alimentatore remoto dimmerabile 1-10v</i> <i>Fernbedienbare dimmbar 1-10-V-Stromversorgung.</i> <i>Fuente de alimentación remota con intensidad luminosa regulable 1-10v</i> <i>Диммируемый блок дистанционного питания 1-10 В</i>	40W DIMMABLE	T73.40W.24.DIM	103,00	84,43
	100W DIMMABLE	T73.100W.24.DIM	155,00	127,05
	150W DIMMABLE	T73.150W.24.DIM	162,00	132,79
	200W DIMMABLE	T73.200W.24.DIM	204,00	167,21
	320W DIMMABLE	T73.320W.24.DIM	277,00	227,05

PRICE LIST \_ E G

PRODUCT	FINISHES	°K	CODE	PAGE	PRICE € incl VAT (22%)	PRICE € excl VAT
 <p><b>EG</b> Wall   Ceiling lamp 390</p>	Dove grey <i>Tortora</i> Taubengrau Gris paloma Тайн	3000 °K	1828.20	95	332,00	272,13
			1828.20.UGR19	-	332,00	272,13
	Dark grey <i>Grigio scuro</i> Dunkelgrau Gris oscuro Темно-серый	3000 °K	1829.20	95	465,00	381,15
			1829.20.UGR19	-	465,00	381,15
	White <i>Bianco</i> Weiß Blanco Белый	3000 °K	1830.20	95	670,00	549,18
			1830.20.UGR19	-	670,00	549,18
 <p><b>EG</b> Wall   Ceiling lamp 560</p>	Dove grey <i>Tortora</i> Taubengrau Gris paloma Тайн	3000 °K	1828.21	95	332,00	272,13
			1828.21.UGR19	-	332,00	272,13
	Dark grey <i>Grigio scuro</i> Dunkelgrau Gris oscuro Темно-серый	3000 °K	1829.21	95	465,00	381,15
			1829.21.UGR19	-	465,00	381,15
	White <i>Bianco</i> Weiß Blanco Белый	3000 °K	1830.21	95	670,00	549,18
			1830.21.UGR19	-	670,00	549,18
 <p><b>EG</b> Wall   Ceiling lamp 760</p>	Dove grey <i>Tortora</i> Taubengrau Gris paloma Тайн	3000 °K	1828.22	95	332,00	272,13
			1828.22.UGR19	-	332,00	272,13
	Dark grey <i>Grigio scuro</i> Dunkelgrau Gris oscuro Темно-серый	3000 °K	1829.22	95	465,00	381,15
			1829.22.UGR19	-	465,00	381,15
	White <i>Bianco</i> Weiß Blanco Белый	3000 °K	1830.22	95	670,00	549,18
			1830.22.UGR19	-	670,00	549,18
	TRIAC Phase-Cut Dimmer	-	DIM0001	-	125,00	102,46

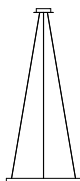
PRODUCT	FINISHES	°K	CODE	PAGE	PRICE € incl VAT (22%)	PRICE € excl VAT			
 <p><b>ANELLO</b> Suspension lamp Ø 55</p>	Painted black <i>Nero verniciato</i> <i>Schwarz lackiert</i> <i>Negro pintado</i> <i>Окрашено в Черный</i>	2700 °K	1790.30.2700	121	735,00	602,46			
			1790.30.2700.D*		841,00	689,34			
		3000 °K	1790.30.3000		735,00	602,46			
			1790.30.3000.D*		841,00	689,34			
	Brushed bronze <i>Bronzo spazzolato</i> <i>Bronze gebürstet</i> <i>Bronce cepillado</i> <i>Брашированная бронза</i>	2700 °K	1799.30.2700	121	735,00	602,46			
			1799.30.2700.D*		841,00	689,34			
		3000 °K	1799.30.3000		735,00	602,46			
			1799.30.3000.D*		841,00	689,34			
	Brushed gold <i>Oro spazzolato</i> <i>Gold gebürstet</i> <i>Oro cepillado</i> <i>Брашированное золото</i>	2700 °K	1800.30.2700	121	735,00	602,46			
			1800.30.2700.D*		841,00	689,34			
		3000 °K	1800.30.3000		735,00	602,46			
			1800.30.3000.D*		841,00	689,34			
	 <p><b>ANELLO</b> Suspension lamp Ø 78</p>	Painted black <i>Nero verniciato</i> <i>Schwarz lackiert</i> <i>Negro pintado</i> <i>Окрашено в Черный</i>	2700 °K	1790.31.2700	121	903,00	740,16		
				1790.31.2700.D*		1.009,00	827,05		
				1790.31.2700.DT**		1.009,00	827,05		
				1790.31.3000		903,00	740,16		
3000 °K			1790.31.3000.D*	1.009,00		827,05			
			1790.31.3000.DT**	1.009,00		827,05			
			Brushed bronze <i>Bronzo spazzolato</i> <i>Bronze gebürstet</i> <i>Bronce cepillado</i> <i>Брашированная бронза</i>	2700 °K		1799.31.2700	121	903,00	740,16
						1799.31.2700.D*		1.009,00	827,05
1799.31.2700.DT**		1.009,00			827,05				
1799.31.3000		903,00			740,16				
3000 °K		1799.31.3000.D*		1.009,00	827,05				
		1799.31.3000.DT**		1.009,00	827,05				
		Brushed gold <i>Oro spazzolato</i> <i>Gold gebürstet</i> <i>Oro cepillado</i> <i>Брашированное золото</i>		2700 °K	1800.31.2700	121		903,00	740,16
					1800.31.2700.D*			1.009,00	827,05
1800.31.2700.DT**			1.009,00		827,05				
1800.31.3000			903,00		740,16				
3000 °K	1800.31.3000.D*		1.009,00	827,05					
	1800.31.3000.DT**		1.009,00	827,05					
	Brushed copper <i>Rame spazzolato</i> <i>Kupfer gebürstet</i> <i>Cobre cepillado</i> <i>Крацованная медь</i>		2700 °K	1801.31.2700	121		903,00	740,16	
				1801.31.2700.D*			1.009,00	827,05	
1801.31.2700.DT**		1.009,00		827,05					
1801.31.3000		903,00		740,16					
3000 °K		1801.31.3000.D*	1.009,00	827,05					
		1801.31.3000.DT**	1.009,00	827,05					

\* Dimmable with: PUSH 0-10V/1-10V/DALI / normally open button  
 Dimmerabile con: PUSH 0-10v / 1-10v/DALI / pulsante normalmente aperto  
 Dimmbar über: PUSH 0-10V / 1-10V/DALI / Taste normalerweise offen  
 Intensidad luminosa regulable con: PUSH 0-10v / 1-10v/DALI / botón normalmente abierta  
 Диммируется с помощью PUSH 0-10 В / 1-10 В/DALI / с нормально разомкнутой кнопкой

\*\* Dimmable with: TRIAC  
 Dimmerabile con: TRIAC  
 Dimmbar über: TRIAC  
 Intensidad luminosa regulable con: TRIAC  
 Диммируется с помощью TRIAC

PRICE LIST \_ A N E L L O

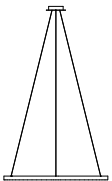
PRODUCT	FINISHES	°K	CODE	PAGE	PRICE € incl VAT (22%)	PRICE € excl VAT
 <p><b>ANELLO</b> Suspension lamp Ø 109</p>	Painted black <i>Nero verniciato</i> Schwarz lackiert Negro pintado Окрашено в Черный	2700 °K	1790.32.2700	121	1.090,00	893,44
			1790.32.2700.D*		1.196,00	980,33
			1790.32.2700.DT**		1.196,00	980,33
		3000 °K	1790.32.3000		1.090,00	893,44
			1790.32.3000.D*		1.196,00	980,33
			1790.32.3000.DT**		1.196,00	980,33
	Brushed bronze <i>Bronzo spazzolato</i> Bronze gebürstet Bronce cepillado Брашированная бронза	2700 °K	1799.32.2700	121	1.090,00	893,44
			1799.32.2700.D*		1.196,00	980,33
			1799.32.2700.DT**		1.196,00	980,33
		3000 °K	1799.32.3000		1.090,00	893,44
			1799.32.3000.D*		1.196,00	980,33
			1799.32.3000.DT**		1.196,00	980,33
	Brushed gold <i>Oro spazzolato</i> Gold gebürstet Oro cepillado Брашированное золото	2700 °K	1800.32.2700	121	1.090,00	893,44
			1800.32.2700.D*		1.196,00	980,33
			1800.32.2700.DT**		1.196,00	980,33
		3000 °K	1800.32.3000		1.090,00	893,44
			1800.32.3000.D*		1.196,00	980,33
			1800.32.3000.DT**		1.196,00	980,33
	Brushed copper <i>Rame spazzolato</i> Kupfer gebürstet Cobre cepillado Крацованная медь	2700 °K	1801.32.2700	121	1.090,00	893,44
			1801.32.2700.D*		1.196,00	980,33
			1800.32.2700.DT**		1.196,00	980,33
		3000 °K	1801.32.3000		1.090,00	893,44
			1801.32.3000.D*		1.196,00	980,33
			1800.32.3000.DT**		1.196,00	980,33

\* Dimmable with: PUSH 0-10V/1-10V/DALI / normally open button  
 Dimmerabile con: PUSH 0-10v / 1-10v/DALI / pulsante normalmente aperto  
 Dimmbar über: PUSH 0-10V / 1-10V/DALI / Taste normalerweise offen  
 Intensidad luminosa regulable con: PUSH 0-10v / 1-10v/DALI / botón normalmente abierto  
 Диммируется с помощью PUSH 0-10 В / 1-10 В/DALI / с нормально разомкнутой кнопкой

\*\* Dimmable with: TRIAC  
 Dimmerabile con: TRIAC  
 Dimmbar über: TRIAC  
 Intensidad luminosa regulable con: TRIAC  
 Диммируется с помощью TRIAC

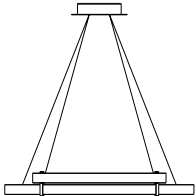
PRODUCT	FINISHES	°K	CODE	PAGE	PRICE € incl VAT (22%)	PRICE € excl VAT	
 <p><b>ANELLO</b> Double suspension lamp (Rings only joint kit not included)</p> <p>Rings only, joint kit not included. <i>Solo anelli. Kit Ganci non incluso. Nur Ringe, Joint Kit nicht inbegriffen. Solo anillos, kit de junta no incluido. Только кольца, соединительный комплект не входит в поставку.</i></p>	Painted black <i>Nero verniciato</i> <i>Schwarz lackiert</i> <i>Negro pintado</i> <i>Окрашено в Черный</i>	2700 °K	1790.33.2700	131	1.639,00	1.343,44	
			1790.33.2700.D*		1.745,00	1.430,33	
			1790.33.2700.DT**		1.745,00	1.430,33	
		3000 °K	1790.33.3000		1.639,00	1.343,44	
			1790.33.3000.D*		1.745,00	1.430,33	
			1790.33.3000.DT**		1.745,00	1.430,33	
	Brushed bronze <i>Bronzo spazzolato</i> <i>Bronze gebürstet</i> <i>Bronce cepillado</i> <i>Брашированная бронза</i>		2700 °K	1799.33.2700	131	1.639,00	1.343,44
				1799.33.2700.D*		1.745,00	1.430,33
				1799.33.2700.DT**		1.745,00	1.430,33
			3000 °K	1799.33.3000		1.639,00	1.343,44
				1799.33.3000.D*		1.745,00	1.430,33
				1799.33.3000.DT**		1.745,00	1.430,33
	Brushed gold <i>Oro spazzolato</i> <i>Gold gebürstet</i> <i>Oro cepillado</i> <i>Брашированное золото</i>		2700 °K	1800.33.2700	131	1.639,00	1.343,44
				1800.33.2700.D*		1.745,00	1.430,33
				1800.33.2700.DT**		1.745,00	1.430,33
			3000 °K	1800.33.3000		1.639,00	1.343,44
				1800.33.3000.D*		1.745,00	1.430,33
				1800.33.3000.DT**		1.745,00	1.430,33
	Brushed copper <i>Rame spazzolato</i> <i>Kupfer gebürstet</i> <i>Cobre cepillado</i> <i>Крацованная медь</i>		2700 °K	1801.33.2700	131	1.639,00	1.343,44
				1801.33.2700.D*		1.745,00	1.430,33
				1801.33.2700.DT**		1.745,00	1.430,33
			3000 °K	1801.33.3000		1.639,00	1.343,44
				1801.33.3000.D*		1.745,00	1.430,33
				1801.33.3000.DT**		1.745,00	1.430,33

\* Dimmable with: PUSH 0-10V/1-10V/DALI / normally open button  
*Dimmerabile con: PUSH 0-10V / 1-10V/DALI / pulsante normalmente aperto*  
*Dimmbar über: PUSH 0-10V / 1-10V/DALI / Taste normalerweise offen*  
*Intensidad luminosa regulable con: PUSH 0-10V / 1-10V/DALI / botón normalmente abierta*  
*Диммируется с помощью PUSH 0-10 В / 1-10 В/DALI / с нормально разомкнутой кнопкой*

\*\* Dimmable with: TRIAC  
*Dimmerabile con: TRIAC*  
*Dimmbar über: TRIAC*  
*Intensidad luminosa regulable con: TRIAC*  
*Диммируется с помощью TRIAC*

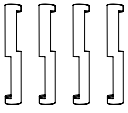
PRODUCT	FINISHES	°K	CODE	PAGE	PRICE € incl VAT (22%)	PRICE € excl VAT
 <p><b>JOINT KIT</b> Double suspension lamp</p>	<p>Set of two clasps for <b>Black Anello</b> series suspension lamp. Set due ganci per sospensione serie Anello <b>colore Nero</b>. Satz mit zwei Haken für die Aufhängung Serie Anello <b>Farbe Schwarz</b>. Juego de dos ganchos para elemento de suspensión serie Anello <b>color negro</b>. Комплект из двух зажимов для Подвесного элемента серии <b>Anello</b> цвет <b>Черный</b>.</p>		<b>1825.BLACK</b>	131	<b>70,00</b>	<b>57,38</b>
	<p>Set of two clasps for <b>Gold Anello</b> series suspension lamp. Set due ganci per sospensione serie Anello <b>colore Oro</b>. Satz mit zwei Haken für die Aufhängung Serie Anello <b>Farbe Gold</b>. Juego de dos ganchos para elemento de suspensión serie Anello <b>color oro</b>. Комплект из двух зажимов для Подвесного элемента серии <b>Anello</b> цвет <b>Золото</b>.</p>		<b>1825.GOLD</b>		<b>70,00</b>	<b>57,38</b>
	<p>Set of two clasps for <b>Copper Anello</b> series suspension lamp. Set due ganci per sospensione serie Anello <b>colore Rame</b>. Satz mit zwei Haken für die Aufhängung Serie Anello <b>Farbe Kupfer</b>. Juego de dos ganchos para elemento de suspensión serie Anello <b>color cobre</b>. Комплект из двух зажимов для Подвесного элемента серии <b>Anello</b> цвет <b>Медь</b>.</p>		<b>1825.COPPER</b>		<b>70,00</b>	<b>57,38</b>
	<p>Set of two clasps for <b>Aluminium Anello</b> series suspension lamp. Set due ganci per sospensione serie Anello <b>colore Alluminio</b>. Satz mit zwei Haken für die Aufhängung Serie Anello <b>Farbe Aluminium</b>. Juego de dos ganchos para elemento de suspensión serie Anello <b>color aluminio</b>. Комплект из двух зажимов для Подвесного элемента серии <b>Anello</b> цвет <b>Алюминий</b>.</p>		<b>1825.ALLUM</b>		<b>70,00</b>	<b>57,38</b>
	<p>Set of two clasps for <b>Bronze Anello</b> series suspension lamp. Set due ganci per sospensione serie Anello <b>colore Bronzo</b>. Satz mit zwei Haken für die Aufhängung Serie Anello <b>Farbe Bronze</b>. Juego de dos ganchos para elemento de suspensión serie Anello <b>color Bronce</b>. Комплект из двух зажимов для Подвесного элемента серии <b>Anello</b> цвет <b>Бронза</b>.</p>		<b>1825.BRONZ</b>		<b>70,00</b>	<b>57,38</b>

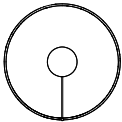
PRODUCT	FINISHES	°K	CODE	PAGE	PRICE € incl VAT (22%)	PRICE € excl VAT
 <p><b>ANELLO</b> Ceiling lamp Ø 55</p>	Painted black <i>Nero verniciato</i> <i>Schwarz lackiert</i> <i>Negro pintado</i> <i>Окрашено в Черный</i>	2700 °K	1790.20.2700	109	909,00	745,08
			1790.20.2700.D*		1.015,00	831,97
		3000 °K	1790.20.3000		909,00	745,08
			1790.20.3000.D*		1.015,00	831,97
	Brushed bronze <i>Bronzo spazzolato</i> <i>Bronze gebürstet</i> <i>Bronce cepillado</i> <i>Брашированная бронза</i>	2700 °K	1799.20.2700	109	909,00	745,08
			1799.20.2700.D*		1.015,00	831,97
		3000 °K	1799.20.3000		909,00	745,08
			1799.20.3000.D*		1.015,00	831,97
	Brushed gold <i>Oro spazzolato</i> <i>Gold gebürstet</i> <i>Oro cepillado</i> <i>Брашированное золото</i>	2700 °K	1800.20.2700	109	909,00	745,08
			1800.20.2700.D*		1.015,00	831,97
		3000 °K	1800.20.3000		909,00	745,08
			1800.20.3000.D*		1.015,00	831,97
	Brushed copper <i>Rame spazzolato</i> <i>Kupfer gebürstet</i> <i>Cobre cepillado</i> <i>Крацованная медь</i>	2700 °K	1801.20.2700	109	909,00	745,08
			1801.20.2700.D*		1.015,00	831,97
		3000 °K	1801.20.3000		909,00	745,08
			1801.20.3000.D*		1.015,00	831,97
 <p><b>ANELLO</b> Ceiling lamp Ø 78</p>	Painted black <i>Nero verniciato</i> <i>Schwarz lackiert</i> <i>Negro pintado</i> <i>Окрашено в Черный</i>	2700 °K	1790.21.2700	109	1.107,00	907,38
			1790.21.2700.D*		1.213,00	994,26
			1790.21.2700.DT**		1.213,00	994,26
		3000 °K	1790.21.3000		1.107,00	907,38
			1790.21.3000.D*		1.213,00	994,26
			1790.21.3000.DT**		1.213,00	994,26
	Brushed bronze <i>Bronzo spazzolato</i> <i>Bronze gebürstet</i> <i>Bronce cepillado</i> <i>Брашированная бронза</i>	2700 °K	1799.21.2700	109	1.107,00	907,38
			1799.21.2700.D*		1.213,00	994,26
			1799.21.2700.DT**		1.213,00	994,26
		3000 °K	1799.21.3000		1.107,00	907,38
			1799.21.3000.D*		1.213,00	994,26
			1799.21.3000.DT**		1.213,00	994,26
	Brushed gold <i>Oro spazzolato</i> <i>Gold gebürstet</i> <i>Oro cepillado</i> <i>Брашированное золото</i>	2700 °K	1800.21.2700	109	1.107,00	907,38
			1800.21.2700.D*		1.213,00	994,26
			1800.21.2700.DT**		1.213,00	994,26
		3000 °K	1800.21.3000		1.107,00	907,38
			1800.21.3000.D*		1.213,00	994,26
			1800.21.3000.DT**		1.213,00	994,26
	Brushed copper <i>Rame spazzolato</i> <i>Kupfer gebürstet</i> <i>Cobre cepillado</i> <i>Крацованная медь</i>	2700 °K	1801.21.2700	109	1.107,00	907,38
			1801.21.2700.D*		1.213,00	994,26
			1801.21.2700.DT**		1.213,00	994,26
		3000 °K	1801.21.3000		1.107,00	907,38
			1801.21.3000.D*		1.213,00	994,26
			1801.21.3000.DT**		1.213,00	994,26

\* Dimmable with: PUSH 0-10V/1-10V/DALI / normally open button  
 Dimmerabile con: PUSH 0-10v / 1-10v/DALI / pulsante normalmente aperto  
 Dimmbar über: PUSH 0-10V / 1-10V/DALI / Taste normalerweise offen  
 Intensidad luminosa regulable con: PUSH 0-10v / 1-10v/DALI / botón normalmente abierto  
 Диммируется с помощью PUSH 0-10 В / 1-10 В/DALI / с нормально разомкнутой кнопкой

\*\* Dimmable with: TRIAC  
 Dimmerabile con: TRIAC  
 Dimmbar über: TRIAC  
 Intensidad luminosa regulable con: TRIAC  
 Диммируется с помощью TRIAC

PRICE LIST \_ A N E L L O

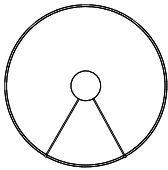
PRODUCT	FINISHES	°K	CODE	PAGE	PRICE € incl VAT (22%)	PRICE € excl VAT
 <p><b>ANELLO</b> Ceiling lamp Ø 109</p>	Painted black <i>Nero verniciato</i> <i>Schwarz lackiert</i> <i>Negro pintado</i> <i>Окрашено в Черный</i>	2700 °K	1790.22.2700	109	1.379,00	1.130,33
			1790.22.2700.D*		1.485,00	1.217,21
			1790.22.2700.DT**		1.485,00	1.217,21
		3000 °K	1790.22.3000	109	1.379,00	1.130,33
			1790.22.3000.D*		1.485,00	1.217,21
			1790.22.3000.DT**		1.485,00	1.217,21
	Brushed bronze <i>Bronzo spazzolato</i> <i>Bronze gebürstet</i> <i>Bronce cepillado</i> <i>Брашированная бронза</i>	2700 °K	109	1799.22.2700	1.379,00	1.130,33
				1799.22.2700.D*	1.485,00	1.217,21
				1799.22.2700.DT**	1.485,00	1.217,21
		3000 °K	109	1799.22.3000	1.379,00	1.130,33
				1799.22.3000.D*	1.485,00	1.217,21
				1799.22.3000.DT**	1.485,00	1.217,21
	Brushed gold <i>Oro spazzolato</i> <i>Gold gebürstet</i> <i>Oro cepillado</i> <i>Брашированное золото</i>	2700 °K	109	1800.22.2700	1.379,00	1.130,33
				1800.22.2700.D*	1.485,00	1.217,21
				1800.22.2700.DT**	1.485,00	1.217,21
		3000 °K	109	1800.22.3000	1.379,00	1.130,33
				1800.22.3000.D*	1.485,00	1.217,21
				1800.22.3000.DT**	1.485,00	1.217,21
Brushed copper <i>Rame spazzolato</i> <i>Kupfer gebürstet</i> <i>Cobre cepillado</i> <i>Крацованная медь</i>	2700 °K	109	1801.22.2700	1.379,00	1.130,33	
			1801.22.2700.D*	1.485,00	1.217,21	
			1801.22.2700.DT**	1.485,00	1.217,21	
	3000 °K	109	1801.22.3000	1.379,00	1.130,33	
			1801.22.3000.D*	1.485,00	1.217,21	
			1801.22.3000.DT**	1.485,00	1.217,21	

\* Dimmable with: PUSH 0-10V/1-10V/DALI / normally open button  
 Dimmerabile con: PUSH 0-10v / 1-10v/DALI / pulsante normalmente aperto  
 Dimmbar über: PUSH 0-10V / 1-10V/DALI / Taste normalerweise offen  
 Intensidad luminosa regulable con: PUSH 0-10v / 1-10v/DALI / botón normalmente abierta  
 Диммируется с помощью PUSH 0-10 В / 1-10 В/DALI / с нормально разомкнутой кнопкой

\*\* Dimmable with: TRIAC  
 Dimmerabile con: TRIAC  
 Dimmbar über: TRIAC  
 Intensidad luminosa regulable con: TRIAC  
 Диммируется с помощью TRIAC

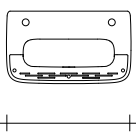
PRODUCT	FINISHES	°K	CODE	PAGE	PRICE € incl VAT (22%)	PRICE € excl VAT
 <p>22,3 cm</p> <p><b>AKI</b> Wall lamp</p>	White Bianco Weiß Blanco Белый	2700 °K	1796.10.2700	147	310,00	254,10
			1796.10.2700.DP*		405,00	331,97
		3000 °K	1796.10.3000		310,00	254,10
			1796.10.3000.DP*		405,00	331,97
		4000 °K	1796.10.4000		310,00	254,10
			1796.10.4000.DP*		405,00	331,97
	Gold Oro Gold Oro Золото	2700 °K	1841.10.2700	147	310,00	254,10
			1841.10.2700.DP*		405,00	331,97
		3000 °K	1841.10.3000		310,00	254,10
			1841.10.3000.DP*		405,00	331,97
		4000 °K	1841.10.4000		310,00	254,10
			1841.10.4000.DP*		405,00	331,97
	Copper Rame Kupfer Сове Медь	2700 °K	1835.10.2700	147	310,00	254,10
			1835.10.2700.DP*		405,00	331,97
		3000 °K	1835.10.3000		310,00	254,10
			1835.10.3000.DP*		405,00	331,97
		4000 °K	1835.10.4000		310,00	254,10
			1835.10.4000.DP*		405,00	331,97
	Bronze Bronzo Bronze Bronze Бронза	2700 °K	1798.10.2700	147	292,00	239,34
			1798.10.2700.DP*		382,00	313,11
		3000 °K	1798.10.3000		310,00	254,10
			1798.10.3000.DP*		405,00	331,97
		4000 °K	1798.10.4000		310,00	254,10
			1798.10.4000.DP*		405,00	331,97
Anthracite grey Antracite Anthrazit Antracita Антрацит	2700 °K	1823.10.2700	147	310,00	254,10	
		1823.10.2700.DP*		405,00	331,97	
	3000 °K	1823.10.3000		310,00	254,10	
		1823.10.3000.DP*		405,00	331,97	
	4000 °K	1823.10.4000		310,00	254,10	
		1823.10.4000.DP*		405,00	331,97	

\* Dimmable with PUSH  
 Dimmerabile con PUSH  
 Dimmbar über PUSH  
 Intensidad luminosa regulable con PUSH  
 Диммируется с помощью PUSH

PRICE LIST \_ A K I

PRODUCT	FINISHES	°K	CODE	PAGE	PRICE € incl VAT (22%)	PRICE € excl VAT
 <p>35,5 cm <b>AKI</b> Wall lamp</p>	White <i>Bianco</i> Weiß <i>Blanco</i> Белый	2700 °K	1796.11.2700	147	375,00	307,38
			1796.11.2700.DP*		471,00	386,07
		3000 °K	1796.11.3000		375,00	307,38
			1796.11.3000.DP*		471,00	386,07
		4000 °K	1796.11.4000		375,00	307,38
			1796.11.4000.DP*		471,00	386,07
	Gold <i>Oro</i> Gold <i>Oro</i> Золото	2700 °K	1841.11.2700	147	375,00	307,38
			1841.11.2700.DP*		471,00	386,07
		3000 °K	1841.11.3000		375,00	307,38
			1841.11.3000.DP*		471,00	386,07
		4000 °K	1841.11.4000		375,00	307,38
			1841.11.4000.DP*		471,00	386,07
	Copper <i>Rame</i> Kupfer <i>Cobre</i> Медь	2700 °K	1835.11.2700	147	375,00	307,38
			1835.11.2700.DP*		471,00	386,07
		3000 °K	1835.11.3000		375,00	307,38
			1835.11.3000.DP*		471,00	386,07
		4000 °K	1835.11.4000		375,00	307,38
			1835.11.4000.DP*		471,00	386,07
	Bronze <i>Bronzo</i> Bronze <i>Bronce</i> Бронза	2700 °K	1798.11.2700	147	375,00	307,38
			1798.11.2700.DP*		471,00	386,07
			1798.11.2700.DT		471,00	386,07
		3000 °K	1798.11.3000		375,00	307,38
			1798.11.3000.DP*		471,00	386,07
		4000 °K	1798.11.4000		375,00	307,38
1798.11.4000.DP*	471,00		386,07			
Anthracite grey <i>Antracite</i> Anthrazit <i>Antracita</i> Антрацит	2700 °K	1823.11.2700	147	375,00	307,38	
		1823.11.2700.DP*		471,00	386,07	
	3000 °K	1823.11.3000		375,00	307,38	
		1823.11.3000.DP*		471,00	386,07	
	4000 °K	1823.11.4000		375,00	307,38	
		1823.11.4000.DP*		471,00	386,07	



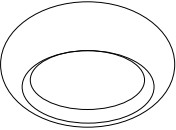

\* Dimmable with PUSH  
Dimmerabile con PUSH  
Dimmbar über PUSH  
Intensidad luminosa regulable con PUSH  
Диммируется с помощью PUSH

PRODUCT	FINISHES	°K	CODE	PAGE	PRICE € incl VAT (22%)	PRICE € excl VAT
 <p><b>OLO</b> Wall lamp</p>	White Bianco Weiß Blanco Белый	2700 °K	<b>1776.10.2700</b>	163	<b>311,00</b>	<b>254,92</b>
		3000 °K	<b>1776.10.3000</b>		<b>311,00</b>	<b>254,92</b>
		4000 °K	<b>1776.10.4000</b>		<b>311,00</b>	<b>254,92</b>
	Brushed gold Oro spazzolato Gold gebürstet Oro cepillado Брашированное золото	2700 °K	<b>1791.10.2700</b>	163	<b>311,00</b>	<b>254,92</b>
		3000 °K	<b>1791.10.3000</b>		<b>311,00</b>	<b>254,92</b>
		4000 °K	<b>1791.10.4000</b>		<b>311,00</b>	<b>254,92</b>
	Brushed copper Rame spazzolato Kupfer gebürstet Cobre cepillado Крацованная медь	2700 °K	<b>1792.10.2700</b>	163	<b>311,00</b>	<b>254,92</b>
		3000 °K	<b>1792.10.3000</b>		<b>311,00</b>	<b>254,92</b>
		4000 °K	<b>1792.10.4000</b>		<b>311,00</b>	<b>254,92</b>
	Brushed bronze Bronzo spazzolato Bronze gebürstet Bronce cepillado Брашированная бронза	2700 °K	<b>1793.10.2700</b>	163	<b>311,00</b>	<b>254,92</b>
		3000 °K	<b>1793.10.3000</b>		<b>311,00</b>	<b>254,92</b>
		4000 °K	<b>1793.10.4000</b>		<b>311,00</b>	<b>254,92</b>
Anthracite grey Antracite Anthrazit Antracita Антрацит	2700 °K	<b>1824.10.2700</b>	163	<b>311,00</b>	<b>254,92</b>	
	3000 °K	<b>1824.10.3000</b>		<b>311,00</b>	<b>254,92</b>	
	4000 °K	<b>1824.10.4000</b>		<b>311,00</b>	<b>254,92</b>	

PRODUCT	CODE	PAGE	PRICE € incl VAT (22%)	PRICE € excl VAT
<p>Remote dimmer controller. Controls up to 6 lamps  <i>Dimmer remoto. Gestisce fino a 6 lampade</i>  <i>Dimmer-Fernbedienung. Verwaltet bis zu 6 Leuchten</i>  <i>Regulador de intensidad remoto. Controla hasta 6 bombillas</i>  <i>Диммер дистанционного управления. Управляет макс. 6 лампами</i></p>	<b>1776.DIM</b>	163	<b>133,00</b>	<b>109,02</b>
<p>Casambi dimmer controller. Controls up to 4 lamps  <i>Dimmer casambi. Gestisce fino a 4 lampade</i>  <i>Casambi-Dimmer. Verwaltet bis zu 4 Leuchten</i>  <i>Regulador de intensidad Casambi. Controla hasta 4 bombillas</i>  <i>Контроллер-диммер Casambi. Управляет макс. 4 лампами</i></p>	<b>1776.CASAMBI</b>		<b>186,00</b>	<b>152,46</b>

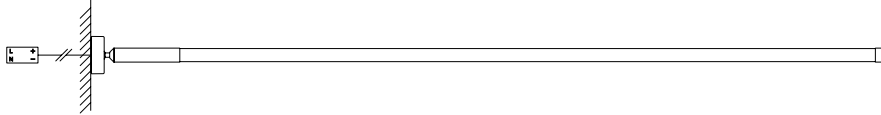
## Wall-wall mounting

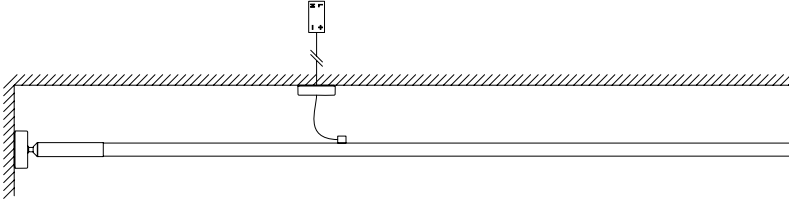
Montaggio Parete/Parete, installazione "Tesata" / Wand/Wand-Montage, Installationsmethode "Tesata" /  
 Montaje en Pared/Pared, instalación "Tesata" / Монтаж от стены до стены, установка с натяжкой

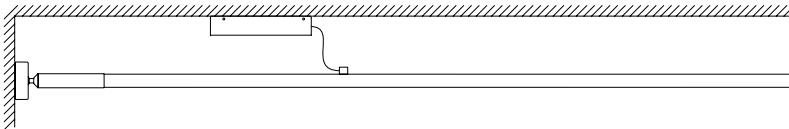
MODEL	PRODUCT
<b>A</b>	
<b>B</b>	
<b>C</b>	
<p>Built-in power supply / Alimentatore a bordo / Integriertes Netzteil / Fuente de alimentación integrada / Встроенный блок питания</p>	
<b>D</b>	
<b>E</b>	

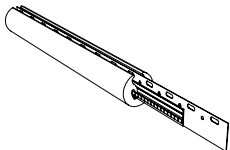

## Wall-wall

Luminaire / Corpo illuminante / Beleuchtungskörper / Luminaria / Светильник

PRODUCT	FINISHES	MT.	°K	CODE	PAGE	PRICE € incl VAT (22%)	PRICE € excl VAT
 <p><b>LINEA System</b></p>	Complete LED line, steel, silicone <i>Linea completa Led, Acciaio, Silicone</i> <i>Linea, komplett mit LED, Stahl &amp; Silikon</i>	1	2700 °K	<b>1795.L1.2700</b>	175	<b>248,00</b>	<b>203,28</b>
		2	2700 °K	<b>1795.L2.2700</b>	175	<b>410,00</b>	<b>336,07</b>
		3	2700 °K	<b>1795.L3.2700</b>	175	<b>571,00</b>	<b>468,03</b>
		4	2700 °K	<b>1795.L4.2700</b>	175	<b>753,00</b>	<b>617,21</b>
		5	2700 °K	<b>1795.L5.2700</b>	175	<b>914,00</b>	<b>749,18</b>
		6	2700 °K	<b>1795.L6.2700</b>	175	<b>1.076,00</b>	<b>881,97</b>
		7	2700 °K	<b>1795.L7.2700</b>	175	<b>1.258,00</b>	<b>1.031,15</b>
		8	2700 °K	<b>1795.L8.2700</b>	175	<b>1.419,00</b>	<b>1.163,11</b>
		9	2700 °K	<b>1795.L9.2700</b>	175	<b>1.580,00</b>	<b>1.295,08</b>
		10	2700 °K	<b>1795.L10.2700</b>	175	<b>1.743,00</b>	<b>1.428,69</b>
	<i>Linea completa LED, acero, silicona</i> <i>Комплексная светодиодная линейка, сталь, силикон</i>	1	3000 °K	<b>1795.L1.3000</b>	175	<b>248,00</b>	<b>203,28</b>
		2	3000 °K	<b>1795.L2.3000</b>	175	<b>410,00</b>	<b>336,07</b>
		3	3000 °K	<b>1795.L3.3000</b>	175	<b>571,00</b>	<b>468,03</b>
		4	3000 °K	<b>1795.L4.3000</b>	175	<b>753,00</b>	<b>617,21</b>
		5	3000 °K	<b>1795.L5.3000</b>	175	<b>914,00</b>	<b>749,18</b>
		6	3000 °K	<b>1795.L6.3000</b>	175	<b>1.076,00</b>	<b>881,97</b>
		7	3000 °K	<b>1795.L7.3000</b>	175	<b>1.258,00</b>	<b>1.031,15</b>
		8	3000 °K	<b>1795.L8.3000</b>	175	<b>1.419,00</b>	<b>1.163,11</b>
		9	3000 °K	<b>1795.L9.3000</b>	175	<b>1.580,00</b>	<b>1.295,08</b>
		10	3000 °K	<b>1795.L10.3000</b>	175	<b>1.743,00</b>	<b>1.428,69</b>

## Wall-wall

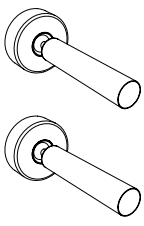
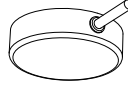
Accessories / Accessori / Zubehör / Accesorios / Аксессуары

ACCESSORIES		FINISHES	CODE	PRICE € incl VAT (22%)	PRICE € excl VAT
	Terminal connections (2pcs) Attacchi terminali (2pc) Endanschlüsse (2 Stck.) Fijaciones terminales (2 uds.) Выводы (2 шт.)	Brushed aluminium Alluminio spazzolato Gebürstetes Aluminium Aluminio cepillado Крацованный алюминий	1795.M1	405,00	331,97
		Black Nero Schwarz Negro Черный	1810.M1	405,00	331,97
		Sand Sabbia Sand Arena Песочный	1811.M1	405,00	331,97
	Remote driver ceiling canopy Rosone per driver remoto Baldachin für entfernt liegenden Driver Rosetón para controlador remoto Потолочная чашка для выносного драйвера  Only <b>B</b> and <b>C</b> with remote power supply Solo <b>B</b> e <b>C</b> e con alimentatore remoto Nur <b>B</b> und <b>C</b> mit entfernt liegendem Netzteil Solo <b>B</b> y <b>C</b> y con fuente de alimentación remota Только <b>B</b> и <b>C</b> с блоком дистанционного питания	Brushed aluminium Alluminio spazzolato Gebürstetes Aluminium Aluminio cepillado Крацованный алюминий	1795.M4	77,00	63,11
		Black Nero Schwarz Negro Черный	1810.M4	77,00	63,11
		Sand Sabbia Sand Arena Песочный	1811.M4	77,00	63,11
	Power cable grip Bloccacavo per cavo alimentazione Kabelklemme für Netzkabel Sujetacables para cable de alimentación Зажим для шнура питания  <b>C</b> only / Solo <b>C</b> / Nur <b>C</b> / Solo <b>C</b> / Только <b>C</b>	Brushed aluminium Alluminio spazzolato Gebürstetes Aluminium Aluminio cepillado Крацованный алюминий	1795.M5	23,00	18,85
		Black Nero Schwarz Negro Черный	1810.M5	23,00	18,85
		Sand Sabbia Sand Arena Песочный	1811.M5	23,00	18,85

\* Up to 2 m, calculate 2 pcs + (1 x m) / over 3 m, calculate 1 pc + (1 x m) / Fino a 2 m calcolare 2 pcs + (1 x m) / oltre i 3 m calcolare 1 pc + (1 x m) / Bis zu 2 m 2 Stck. berechnen (1 pro m) / bei mehr als 3 m 1 Stck. + (1 pro m) berechnen / Hasta 2 m calcular 2 uds. + (1 x m) / A partir de 3 m calcular 1 ud. + (1 x m) / До 2 м нужно учитывать 2 шт. + (1 x м) / свыше 3 м нужно учитывать 1 шт. + (1 x м)

## Wall-wall

Drivers and ceiling canopies / Driver e rosoni / Driver und Baldachine / Controladores y rosetones / Драйверы и основания

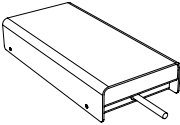
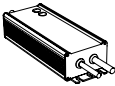
ACCESSORIES	FINISHES	W	Max MT	CODE	PRICE € incl VAT (22%)	PRICE € excl VAT
 <p>Power supply with cover Alimentatore con cover Netzteil mit Abdeckung Fuente de alimentación con cubierta Блок питания с крышкой</p>	Brushed aluminium Alluminio spazzolato Gebürstetes Aluminium Aluminio cepillado Крацованный алюминий	75W On-Off	Max 3.5 mt	<b>1795.B1</b>	<b>140,00</b>	<b>114,75</b>
		150W On-Off	Max 7.5 mt	<b>1795.B2</b>	<b>159,00</b>	<b>130,33</b>
		200W On-Off	Max 10 mt	<b>1795.B3</b>	<b>252,00</b>	<b>206,56</b>
		60W Dimmer	Max 3 mt	<b>1795.B4*</b>	<b>205,00</b>	<b>168,03</b>
		120W Dimmer	Max 6 mt	<b>1795.B5*</b>	<b>260,00</b>	<b>213,11</b>
		240W Dimmer	Max 10 mt	<b>1795.B6*</b>	<b>310,00</b>	<b>254,10</b>
	Black Nero Schwarz Negro Черный	75W On-Off	Max 3.5 mt	<b>1810.B1</b>	<b>140,00</b>	<b>114,75</b>
		150W On-Off	Max 7.5 mt	<b>1810.B2</b>	<b>159,00</b>	<b>130,33</b>
		200W On-Off	Max 10 mt	<b>1810.B3</b>	<b>252,00</b>	<b>206,56</b>
		60W Dimmer	Max 3 mt	<b>1810.B4*</b>	<b>205,00</b>	<b>168,03</b>
		120W Dimmer	Max 6 mt	<b>1810.B5*</b>	<b>260,00</b>	<b>213,11</b>
		240W Dimmer	Max 10 mt	<b>1810.B6*</b>	<b>310,00</b>	<b>254,10</b>
	Sand Sabbia Sandfarben Arena Песочный	75W On-Off	Max 3.5 mt	<b>1811.B1</b>	<b>140,00</b>	<b>114,75</b>
		150W On-Off	Max 7.5 mt	<b>1811.B2</b>	<b>159,00</b>	<b>130,33</b>
		200W On-Off	Max 10 mt	<b>1811.B3</b>	<b>252,00</b>	<b>206,56</b>
		60W Dimmer	Max 3 mt	<b>1811.B4*</b>	<b>205,00</b>	<b>168,03</b>
		120W Dimmer	Max 6 mt	<b>1811.B5*</b>	<b>260,00</b>	<b>213,11</b>
		240W Dimmer	Max 10 mt	<b>1811.B6*</b>	<b>310,00</b>	<b>254,10</b>
 <p>Remote power supply Alimentatore remoto Entfernt liegendes Netzteil Fuente de alimentación remota Блок дистанционного питания</p>	75W On-Off	Max 3.5 mt	<b>1795.R1</b>	<b>54,00</b>	<b>44,26</b>	
	150W On-Off	Max 7.5 mt	<b>1795.R2</b>	<b>73,00</b>	<b>59,84</b>	
	200W On-Off	Max 10 mt	<b>1795.R3</b>	<b>165,00</b>	<b>135,25</b>	
	60W Dimmer	Max 3 mt	<b>1795.R4*</b>	<b>113,00</b>	<b>92,62</b>	
	120W Dimmer	Max 6 mt	<b>1795.R5*</b>	<b>168,00</b>	<b>137,70</b>	
	240W Dimmer	Max 12 mt	<b>1795.R6*</b>	<b>218,00</b>	<b>178,69</b>	

\* Dimmable with: 1 ~ 10Vdc, 10V PWM signal and resistance  
Dimmerabile con: 1 ~ 10Vdc, 10V PWM segnale e resistenza  
Dimmbar über: 1~10Vdc, 10V PWM-Signal und Widerstand  
Intensidad luminosa regulable con: 1 ~ 10 Vcc, 10 V PWM señal y resistencia  
Диммируется с помощью 1 ~ 10 В постоянн. тока, ШИМ-сигнала 10 В и резистора

## Surface mounting

Montaggio Superficiale, installazione "Parete-Soffitto" / Aufputzmontage, Installation Wand-Decke /  
 Montaje en superficie, instalación Pared-Techo / Поверхностный монтаж, установка «стена-потолок»

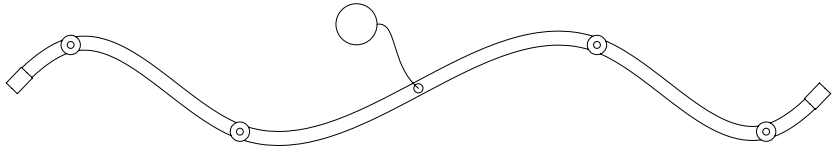
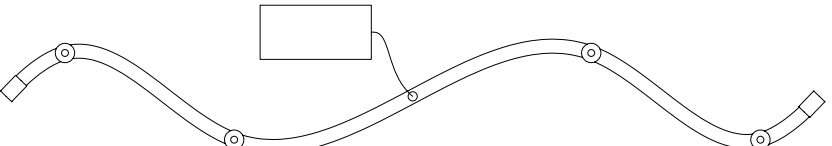
MODEL	PRODUCT
<p style="text-align: center;"><b>A</b></p>	 <p>The diagram shows a wavy, double-line profile with four circular mounting points. A circular callout is connected to the second mounting point from the left.</p>
<p style="text-align: center;"><b>B</b></p>	 <p>The diagram shows the same wavy, double-line profile with four circular mounting points. A rectangular callout is connected to the second mounting point from the left.</p>

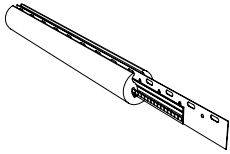

## Surface mounting

Luminaire / Corpo illuminante / Beleuchtungskörper / Luminaria / Светильник

PRODUCT	FINISHES	MT.	°K	CODE	PAGE	PRICE € incl VAT (22%)	PRICE € excl VAT	
 <p><b>LINEA System</b></p>	Complete LED line, steel, silicone <i>Linea completa Led, Acciaio, Silicone</i> <i>Linea, komplett mit LED, Stahl &amp; Silikon</i> <i>Linea completa LED, acero, silicona</i> <i>Комплексная светодиодная линейка, сталь, силикон</i>	1	2700 °K	<b>1795.L1.2700</b>	185	<b>234,00</b>	<b>191,80</b>	
		2	2700 °K	<b>1795.L2.2700</b>	185	<b>387,00</b>	<b>317,21</b>	
		3	2700 °K	<b>1795.L3.2700</b>	185	<b>539,00</b>	<b>441,80</b>	
		4	2700 °K	<b>1795.L4.2700</b>	185	<b>710,00</b>	<b>581,97</b>	
		5	2700 °K	<b>1795.L5.2700</b>	185	<b>862,00</b>	<b>706,56</b>	
		6	2700 °K	<b>1795.L6.2700</b>	185	<b>1.015,00</b>	<b>831,97</b>	
		7	2700 °K	<b>1795.L7.2700</b>	185	<b>1.187,00</b>	<b>972,95</b>	
		8	2700 °K	<b>1795.L8.2700</b>	185	<b>1.339,00</b>	<b>1.097,54</b>	
		9	2700 °K	<b>1795.L9.2700</b>	185	<b>1.491,00</b>	<b>1.222,13</b>	
		10	2700 °K	<b>1795.L10.2700</b>	185	<b>1.644,00</b>	<b>1.347,54</b>	
			1	3000 °K	<b>1795.L1.3000</b>	185	<b>234,00</b>	<b>191,80</b>
			2	3000 °K	<b>1795.L2.3000</b>	185	<b>387,00</b>	<b>317,21</b>
			3	3000 °K	<b>1795.L3.3000</b>	185	<b>539,00</b>	<b>441,80</b>
			4	3000 °K	<b>1795.L4.3000</b>	185	<b>710,00</b>	<b>581,97</b>
			5	3000 °K	<b>1795.L5.3000</b>	185	<b>862,00</b>	<b>706,56</b>
			6	3000 °K	<b>1795.L6.3000</b>	185	<b>1.015,00</b>	<b>831,97</b>
			7	3000 °K	<b>1795.L7.3000</b>	185	<b>1.187,00</b>	<b>972,95</b>
			8	3000 °K	<b>1795.L8.3000</b>	185	<b>1.339,00</b>	<b>1.097,54</b>
			9	3000 °K	<b>1795.L9.3000</b>	185	<b>1.491,00</b>	<b>1.222,13</b>
			10	3000 °K	<b>1795.L10.3000</b>	185	<b>1.644,00</b>	<b>1.347,54</b>

## Surface mounting

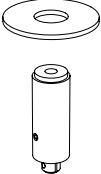
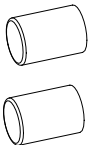
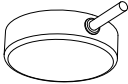
Accessories / Accessori / Zubehör / Accesorios / Аксессуары

ACCESSORIES		FINISHES	CODE	PRICE € incl VAT (22%)	PRICE € excl VAT
	Wall/ceiling connections (1pc) <i>Attacchi parete/soffitto (1pc)</i> <i>Wand-/Deckenanschlüsse (1 Stck.)</i> <i>Fijaciones pared/techo (1 ud.)</i> <i>Крепления к стене/потолку (1 шт.)</i>	Brushed aluminium <i>Alluminio spazzolato</i> <i>Gebürstetes Aluminium</i> <i>Aluminio cepillado</i> <i>Крацованный алюминий</i>	1795.M2	35,00	28,69
		Black <i>Nero</i> <i>Schwarz</i> <i>Negro</i> <i>Черный</i>	1810.M2	35,00	28,69
		Sand <i>Sabbia</i> <i>Sand</i> <i>Arena</i> <i>Песочный</i>	1811.M2	35,00	28,69
	Terminals (2pcs) <i>Terminali (2pcs),</i> <i>Endanschlüsse (2 Stck.)</i> <i>Terminales (2 uds.),</i> <i>Наконечники (2 шт.)</i>	Brushed aluminium <i>Alluminio spazzolato</i> <i>Gebürstetes Aluminium</i> <i>Aluminio cepillado</i> <i>Крацованный алюминий</i>	1795.M3	45,00	36,89
		Black <i>Nero</i> <i>Schwarz</i> <i>Negro</i> <i>Черный</i>	1810.M3	45,00	36,89
		Sand <i>Sabbia</i> <i>Sand</i> <i>Arena</i> <i>Песочный</i>	1811.M3	45,00	36,89
	Remote driver ceiling canopy <i>Rosone per driver remoto</i> <i>Baldachin für entfernt liegenden Drive</i> <i>Rosetón para controlador remoto</i> <i>Потолочная чашка для выносного драйвера</i>  <b>A only / Solo A / Nur A / Solo A / Только A</b>	Brushed aluminium <i>Alluminio spazzolato</i> <i>Gebürstetes Aluminium</i> <i>Aluminio cepillado</i> <i>Крацованный алюминий</i>	1795.M4	82,00	67,21
		Black <i>Nero</i> <i>Schwarz</i> <i>Negro</i> <i>Черный</i>	1810.M4	82,00	67,21
		Sand <i>Sabbia</i> <i>Sand</i> <i>Arena</i> <i>Песочный</i>	1811.M4	82,00	67,21
	Power cable grip <i>Bloccacavo per cavo alimentazione</i> <i>Kabelklemme für Netzkabel</i> <i>Sujetacables para cable de alimentación</i> <i>Зажим для шнура питания</i>	Brushed aluminium <i>Alluminio spazzolato</i> <i>Gebürstetes Aluminium</i> <i>Aluminio cepillado</i> <i>Крацованный алюминий</i>	1795.M5	24,00	19,67
		Black <i>Nero</i> <i>Schwarz</i> <i>Negro</i> <i>Черный</i>	1810.M5	24,00	19,67
		Sand <i>Sabbia</i> <i>Sand</i> <i>Arena</i> <i>Песочный</i>	1811.M5	24,00	19,67

\* Up to 2 m, calculate 2 pcs + (1 x m) / over 3 m, calculate 1 pc + (1 x m) / Fino a 2 m calcolare 2 pcs + (1 x m) / oltre i 3 m calcolare 1 pc + (1 x m) / Bis zu 2 m 2 Stck. berechnen (1 pro m) / bei mehr als 3 m 1 Stck. + (1 pro m) berechnen / Hasta 2 m calcular 2 uds. + (1 x m) / A partir de 3 m calcular 1 ud. + (1 x m) / До 2 м нужно учитывать 2 шт. + (1 x м) / свыше 3 м нужно учитывать 1 шт. + (1 x м)

## Surface mounting

Drivers and canopies / Driver e rosoni / Driver und Baldachine / Controladores y rosetones / Драйверы и основания

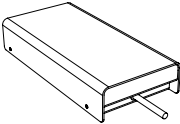
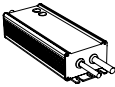
ACCESSORIES	FINISHES	W	Max MT	CODE	PRICE € incl VAT (22%)	PRICE € excl VAT
 <p>Power supply with cover Alimentatore con cover Netzteil mit Abdeckung Fuente de alimentación con cubierta Блок питания с крышкой</p> <p><b>B</b> only / Solo <b>B</b> / Nur <b>B</b> / Solo <b>B</b> / Только <b>B</b></p>	Brushed aluminium Alluminio spazzolato Gebürstetes Aluminium Aluminio cepillado Крацованный алюминий	75W On-Off	Max 3.5 mt	<b>1795.B1</b>	<b>148,00</b>	<b>121,31</b>
		150W On-Off	Max 7.5 mt	<b>1795.B2</b>	<b>169,00</b>	<b>138,52</b>
		200W On-Off	Max 10 mt	<b>1795.B3</b>	<b>267,00</b>	<b>218,85</b>
		60W Dimmer	Max 3 mt	<b>1795.B4*</b>	<b>217,00</b>	<b>177,87</b>
		120W Dimmer	Max 6 mt	<b>1795.B5*</b>	<b>276,00</b>	<b>226,23</b>
		240W Dimmer	Max 10 mt	<b>1795.B6*</b>	<b>329,00</b>	<b>269,67</b>
	Black Nero Schwarz Negro Черный	75W On-Off	Max 3.5 mt	<b>1810.B1</b>	<b>148,00</b>	<b>121,31</b>
		150W On-Off	Max 7.5 mt	<b>1810.B2</b>	<b>169,00</b>	<b>138,52</b>
		200W On-Off	Max 10 mt	<b>1810.B3</b>	<b>267,00</b>	<b>218,85</b>
		60W Dimmer	Max 3 mt	<b>1810.B4*</b>	<b>217,00</b>	<b>177,87</b>
		120W Dimmer	Max 6 mt	<b>1810.B5*</b>	<b>276,00</b>	<b>226,23</b>
		240W Dimmer	Max 10 mt	<b>1810.B6*</b>	<b>329,00</b>	<b>269,67</b>
	Sand Sabbia Sand Arena Песочный	75W On-Off	Max 3.5 mt	<b>1811.B1</b>	<b>148,00</b>	<b>121,31</b>
		150W On-Off	Max 7.5 mt	<b>1811.B2</b>	<b>169,00</b>	<b>138,52</b>
		200W On-Off	Max 10 mt	<b>1811.B3</b>	<b>267,00</b>	<b>218,85</b>
		60W Dimmer	Max 3 mt	<b>1811.B4*</b>	<b>217,00</b>	<b>177,87</b>
		120W Dimmer	Max 6 mt	<b>1811.B5*</b>	<b>276,00</b>	<b>226,23</b>
		240W Dimmer	Max 10 mt	<b>1811.B6*</b>	<b>329,00</b>	<b>269,67</b>
 <p>Remote power supply Alimentatore remoto Entfernt liegendes Netzteil Fuente de alimentación remota Удаленный блок питания</p> <p><b>A</b> only / Solo <b>A</b> / Nur <b>A</b> / Solo <b>A</b> / Только <b>A</b></p>	75W On-Off	Max 3.5 mt	<b>1795.R1</b>	<b>57,00</b>	<b>46,72</b>	
	150W On-Off	Max 7.5 mt	<b>1795.R2</b>	<b>77,00</b>	<b>63,11</b>	
	200W On-Off	Max 10 mt	<b>1795.R3</b>	<b>175,00</b>	<b>143,44</b>	
	60W Dimmer	Max 3 mt	<b>1795.R4*</b>	<b>120,00</b>	<b>98,36</b>	
	120W Dimmer	Max 6 mt	<b>1795.R5*</b>	<b>178,00</b>	<b>145,90</b>	
	240W Dimmer	Max 12 mt	<b>1795.R6*</b>	<b>231,00</b>	<b>189,34</b>	

\* Dimmable with: 1 ~ 10Vdc, 10V PWM signal and resistance  
Dimmerabile con: 1 ~ 10Vdc, 10V PWM segnale e resistenza  
Dimmbar über: 1~10Vdc, 10V PWM-Signal und Widerstand  
Intensidad luminosa regulable con: 1 ~ 10 Vcc, 10 V PWM señal y resistencia  
Диммируется с помощью 1 ~ 10 В постоян. тока, ШИМ-сигнала 10 В и резистора

## Vertical suspension

Sospensione verticale / Vertikale Aufhängung / Suspensión vertical / Вертикальное подвешивание

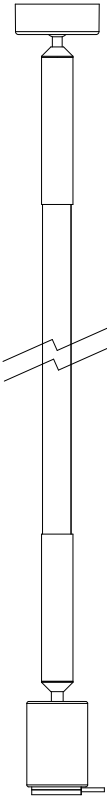
PRODUCT		FINISHES	°K	CODE	PAGE	PRICE € incl VAT (22%)	PRICE € excl VAT
 <p><b>LINEA System</b></p>	<p>3 m vertical suspension line (can be shortened to the desired measure) <i>Linea sospensione verticale 3 m accorciabile a misura</i> <i>Linea vertikale Aufhängung 3m nach Maß kürzbar</i> <i>Línea suspensión vertical 3 m, puede cortarse a medida</i> <i>Держатель для вертикального подвешивания длиной 3 м, укорачивается по индивидуальным размерам</i></p>	<p>Brushed aluminium <i>Alluminio spazzolato</i> <i>Gebürstetes Aluminium</i> <i>Aluminio cepillado</i> <i>Крацованный алюминий</i></p>	2700 °K	<b>1795.S4.2700</b>	189	<b>856,00</b>	<b>701,64</b>
			3000 °K	<b>1795.S4.3000</b>	189	<b>856,00</b>	<b>701,64</b>
		<p>Black <i>Nero</i> <i>Schwarz</i> <i>Negro</i> <i>Черный</i></p>	2700 °K	<b>1810.S4.2700</b>	189	<b>999,00</b>	<b>818,85</b>
			3000 °K	<b>1810.S4.3000</b>	189	<b>999,00</b>	<b>818,85</b>
		<p>Sand <i>Sabbia</i> <i>Sand</i> <i>Arena</i> <i>Песочный</i></p>	2700 °K	<b>1811.S4.2700</b>	189	<b>999,00</b>	<b>818,85</b>
			3000 °K	<b>1811.S4.3000</b>	189	<b>999,00</b>	<b>818,85</b>



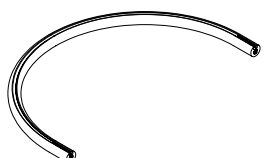

## Horizontal suspension

Sospensione orizzontale / Horizontale Aufhängung / Suspensión horizontal / Горизонтальное подвешивание

PRODUCT		°K	CODE	PAGE	PRICE € incl VAT (22%)	PRICE € excl VAT
 <p><b>LINEA System</b></p>	<p>Linear element Elemento lineare Lineares Element Elemento lineal Линейный элемент</p> <p>120 cm - 24W</p>	2700 °K	<b>1795.S1.2700</b>	197	<b>501,00</b>	<b>410,66</b>
		3000 °K	<b>1795.S1.3000</b>	197	<b>501,00</b>	<b>410,66</b>
 <p><b>LINEA System</b></p>	<p>90° bend Curva 90° Kurve 90° Curva 90° Изогнутый элемент 90°</p> <p>11W</p>	2700 °K	<b>1795.S2.2700</b>	197	<b>346,00</b>	<b>283,61</b>
		3000 °K	<b>1795.S2.3000</b>	197	<b>346,00</b>	<b>283,61</b>
 <p><b>LINEA System</b></p>	<p>180° bend Curva 180° Kurve 180° Curva 180° Изогнутый элемент 180°</p> <p>20W</p>	2700 °K	<b>1795.S3.2700</b>	197	<b>448,00</b>	<b>367,21</b>
		3000 °K	<b>1795.S3.3000</b>	197	<b>448,00</b>	<b>367,21</b>

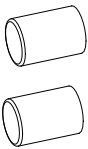
## Horizontal suspension

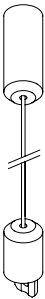
Accessories / Accessori / Zubehör / Accesorios / Аксессуары

ACCESSORIES		FINISHES	CODE	PRICE € incl VAT (22%)	PRICE € excl VAT
	Terminals (2pcs) <i>Terminali (2pcs), Endanschlüsse (2 Stck.) Terminales (2 uds.), Наконечники (2 шт.)</i>	Brushed aluminium <i>Alluminio spazzolato Gebürstetes Aluminium Aluminio serillado Крацованный алюминий</i>	1795.M3	42,00	34,43
		Black <i>Nero Schwarz Negro Черный</i>	1810.M3	42,00	34,43
		Sand <i>Sabbia Sand Arena Песочный</i>	1811.M3	42,00	34,43
	Remote driver ceiling canopy <i>Rosone per driver remoto Baldachin für entfernt liegenden Drive Rosetón para controlador remoto Потолочная чашка для выносного драйвера</i>	Brushed aluminium <i>Alluminio spazzolato Gebürstetes Aluminium Aluminio serillado Крацованный алюминий</i>	1795.M4	77,00	63,11
		Black <i>Nero Schwarz Negro Черный</i>	1810.M4	77,00	63,11
		Sand <i>Sabbia Sand Arena Песочный</i>	1811.M4	77,00	63,11
	Power cable grip <i>Bloccacavo per cavo alimentazione Kabelklemme für Netzkabel Sujetacables para cable de alimentación Зажим для шнура питания</i>	Brushed aluminium <i>Alluminio spazzolato Gebürstetes Aluminium Aluminio serillado Крацованный алюминий</i>	1795.M5	23,00	18,85
		Black <i>Nero Schwarz Negro Черный</i>	1810.M5	23,00	18,85
		Sand <i>Sabbia Sand Arena Песочный</i>	1811.M5	23,00	18,85
	Additional 120 cm suspension cable kit <i>Kit cavetto di sospensione supplementare 120 cm Zusätzlicher Aufhängungs-Kabelsatz 120 cm Kit cable de suspensión adicional 120 cm Комплект с дополнительным кабелем для подвешивания 120 см</i>	Brushed aluminium <i>Alluminio spazzolato Gebürstetes Aluminium Aluminio serillado Крацованный алюминий</i>	1795.M6	65,00	53,28
		Black <i>Nero Schwarz Negro Черный</i>	1810.M6	65,00	53,28
		Sand <i>Sabbia Sand Arena Песочный</i>	1811.M6	65,00	53,28
	Closed joint <i>Giunto chiuso Geschlossenes Gelenk Junta cerrada Накладка на стык</i>	Brushed aluminium <i>Alluminio spazzolato Gebürstetes Aluminium Aluminio serillado Крацованный алюминий</i>	1795.M7	21,00	17,21
		Black <i>Nero Schwarz Negro Черный</i>	1810.M7	21,00	17,21
		Sand <i>Sabbia Sand Arena Песочный</i>	1811.M7	21,00	17,21

\* Up to 2 m, calculate 2 pcs + (1 x m) / over 3 m, calculate 1 pc + (1 x m) / Fino a 2 m calcolare 2 pcs + (1 x m) / oltre i 3 m calcolare 1 pc + (1 x m) / Bis zu 2 m 2 Stck. berechnen (1 pro m) / bei mehr als 3 m 1 Stck. + (1 pro m) berechnen / Hasta 2 m calcular 2 uds. + (1 x m) / A partir de 3 m calcular 1 ud. + (1 x m) / До 2 м нужно учитывать 2 шт. + (1 x m) / свыше 3 м нужно учитывать 1 шт. + (1 x m)

## Horizontal suspension

Drivers and canopies / Driver e rosoni / Driver und Baldachin / Controladores y rosetones / Драйверы и основания

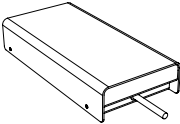
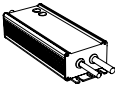
ACCESSORIES	FINISHES	W	Max MT	CODE	PRICE € incl VAT (22%)	PRICE € excl VAT
 <p>Power supply with cover Alimentatore con cover Netzteil mit Abdeckung Fuente de alimentación con cubierta Блок питания с крышкой</p>	Brushed aluminium Alluminio spazzolato Gebürstetes Aluminium Aluminio cepillado Крацованный алюминий	75W On-Off	Max 3.5 mt	<b>1795.B1</b>	<b>140,00</b>	<b>114,75</b>
		150W On-Off	Max 7.5 mt	<b>1795.B2</b>	<b>159,00</b>	<b>130,33</b>
		200W On-Off	Max 10 mt	<b>1795.B3</b>	<b>252,00</b>	<b>206,56</b>
		60W Dimmer	Max 3 mt	<b>1795.B4*</b>	<b>205,00</b>	<b>168,03</b>
		120W Dimmer	Max 6 mt	<b>1795.B5*</b>	<b>260,00</b>	<b>213,11</b>
		240W Dimmer	Max 10 mt	<b>1795.B6*</b>	<b>310,00</b>	<b>254,10</b>
	Black Nero Schwarz Negro Черный	75W On-Off	Max 3.5 mt	<b>1810.B1</b>	<b>140,00</b>	<b>114,75</b>
		150W On-Off	Max 7.5 mt	<b>1810.B2</b>	<b>159,00</b>	<b>130,33</b>
		200W On-Off	Max 10 mt	<b>1810.B3</b>	<b>252,00</b>	<b>206,56</b>
		60W Dimmer	Max 3 mt	<b>1810.B4*</b>	<b>205,00</b>	<b>168,03</b>
		120W Dimmer	Max 6 mt	<b>1810.B5*</b>	<b>260,00</b>	<b>213,11</b>
		240W Dimmer	Max 10 mt	<b>1810.B6*</b>	<b>310,00</b>	<b>254,10</b>
	Sand Sabbia Sand Arena Песочный	75W On-Off	Max 3.5 mt	<b>1811.B1</b>	<b>140,00</b>	<b>114,75</b>
		150W On-Off	Max 7.5 mt	<b>1811.B2</b>	<b>159,00</b>	<b>130,33</b>
		200W On-Off	Max 10 mt	<b>1811.B3</b>	<b>252,00</b>	<b>206,56</b>
		60W Dimmer	Max 3 mt	<b>1811.B4*</b>	<b>205,00</b>	<b>168,03</b>
		120W Dimmer	Max 6 mt	<b>1811.B5*</b>	<b>260,00</b>	<b>213,11</b>
		240W Dimmer	Max 10 mt	<b>1811.B6*</b>	<b>310,00</b>	<b>254,10</b>
 <p>Remote power supply Alimentatore remoto Entfernt liegendes Netzteil Fuente de alimentación remota Блок дистанционного питания</p>	75W On-Off	Max 3.5 mt	<b>1795.R1</b>	<b>54,00</b>	<b>44,26</b>	
	150W On-Off	Max 7.5 mt	<b>1795.R2</b>	<b>73,00</b>	<b>59,84</b>	
	200W On-Off	Max 10 mt	<b>1795.R3</b>	<b>165,00</b>	<b>135,25</b>	
	60W Dimmer	Max 3 mt	<b>1795.R4*</b>	<b>113,00</b>	<b>92,62</b>	
	120W Dimmer	Max 6 mt	<b>1795.R5*</b>	<b>168,00</b>	<b>137,70</b>	
	240W Dimmer	Max 12 mt	<b>1795.R6*</b>	<b>218,00</b>	<b>178,69</b>	

\* Dimmable with: 1 ~ 10Vdc, 10V PWM signal and resistance  
Dimmerabile con: 1 ~ 10Vdc, 10V PWM segnale e resistenza  
Dimmbar über: 1~10Vdc, 10V PWM-Signal und Widerstand  
Intensidad luminosa regulable con: 1 ~ 10 Vcc, 10 V PWM señal y resistencia  
Диммируется с помощью 1 ~ 10 В постоян. тока, ШИМ-сигнала 10 В и резистора

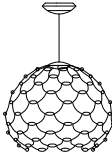
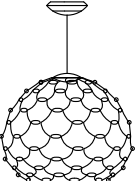
PRODUCT	FINISHES	°K	CODE	PAGE	PRICE € incl VAT (22%)	PRICE € excl VAT	
 <p><b>LAMOI</b> Suspension lamp Ø 40</p>	Gold Oro Gold Oro Золото	2700 °K	1812.30.2700	215	1.156,00	947,54	
			1812.30.2700.D*		1.262,00	1.034,43	
		3000 °K	1812.30.3000		1.156,00	947,54	
			1812.30.3000.D*		1.262,00	1.034,43	
	Plastic covers, <i>Coperture plastica, Kunststoffabdeckungen, Cubiertas de plástico, Пластиковые крышки</i>				1812.30.KIT.COVER	220,00	180,33
	Copper Rame Kupfer Cobre Медь	2700 °K	1816.30.2700		215	1.156,00	947,54
			1816.30.2700.D*			1.262,00	1.034,43
		3000 °K	1816.30.3000			1.156,00	947,54
			1816.30.3000.D*	1.262,00		1.034,43	
	Plastic covers, <i>Coperture plastica, Kunststoffabdeckungen, Cubiertas de plástico, Пластиковые крышки</i>			1816.30.KIT.COVER		220,00	180,33
	Chrome Cromo Chrom Cromo Хром	2700 °K	1817.30.2700	215		1.156,00	947,54
			1817.30.2700.D*			1.262,00	1.034,43
		3000 °K	1817.30.3000			1.156,00	947,54
			1817.30.3000.D*		1.262,00	1.034,43	
Plastic covers, <i>Coperture plastica, Kunststoffabdeckungen, Cubiertas de plástico, Пластиковые крышки</i>			1817.30.KIT.COVER		220,00	180,33	
 <p><b>LAMOI</b> Suspension lamp Ø 60</p>	Gold Oro Gold Oro Золото	2700 °K	1812.31.2700		215	1.482,00	1.214,75
			1812.31.2700.D*			1.588,00	1.301,64
			1812.31.2700.DT**			1.588,00	1.301,64
		3000 °K	1812.31.3000	1.482,00		1.214,75	
			1812.31.3000.D*	1.588,00		1.301,64	
			1812.31.3000.DT**	1.588,00		1.301,64	
	Plastic covers, <i>Coperture plastica, Kunststoffabdeckungen, Cubiertas de plástico, Пластиковые крышки</i>			1812.31.KIT.COVER	323,00	264,75	
	Copper Rame Kupfer Cobre Медь	2700 °K	1816.31.2700	215	1.482,00	1.214,75	
			1816.31.2700.D*		1.588,00	1.301,64	
			1816.31.2700.DT**		1.588,00	1.301,64	
		3000 °K	1816.31.3000		1.482,00	1.214,75	
			1816.31.3000.D*		1.588,00	1.301,64	
			1816.31.3000.DT**		1.588,00	1.301,64	
	Plastic covers, <i>Coperture plastica, Kunststoffabdeckungen, Cubiertas de plástico, Пластиковые крышки</i>			1816.31.KIT.COVER	323,00	264,75	
	Chrome Cromo Chrom Cromo Хром	2700 °K	1817.31.2700	215	1.482,00	1.214,75	
			1817.31.2700.D*		1.588,00	1.301,64	
			1817.31.2700.DT**		1.588,00	1.301,64	
		3000 °K	1817.31.3000		1.482,00	1.214,75	
1817.31.3000.D*			1.588,00		1.301,64		
1817.31.3000.DT**			1.588,00		1.301,64		
Plastic covers, <i>Coperture plastica, Kunststoffabdeckungen, Cubiertas de plástico, Пластиковые крышки</i>			1817.31.KIT.COVER	323,00	264,75		

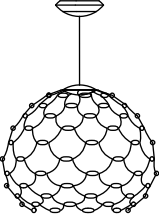
PRODUCT	FINISHES	°K	CODE	PAGE	PRICE € incl VAT (22%)	PRICE € excl VAT	
 <p><b>LAMOI</b> Suspension lamp Ø 80</p>	Gold Oro Gold Oro Золото	2700 °K	1812.32.2700	215	1.954,00	1.601,64	
			1812.32.2700.D*		2.060,00	1.688,52	
		3000 °K	1812.32.3000		1.954,00	1.601,64	
			1812.32.3000.D*		2.060,00	1.688,52	
	Plastic covers, <i>Coperture plastica, Kunststoffabdeckungen, Cubiertas de plástico, Пластиковые крышки</i>			1812.32.KIT.COVER		446,00	365,57
	Copper Rame Kupfer Cobre Медь	2700 °K	1816.32.2700	215	1.954,00	1.601,64	
			1816.32.2700.D*		2.060,00	1.688,52	
		3000 °K	1816.32.3000		1.954,00	1.601,64	
			1816.32.3000.D*		2.060,00	1.688,52	
	Plastic covers, <i>Coperture plastica, Kunststoffabdeckungen, Cubiertas de plástico, Пластиковые крышки</i>			1816.32.KIT.COVER		446,00	365,57
	Chrome Cromo Chrom Cromo Хром	2700 °K	1817.32.2700	215	1.954,00	1.601,64	
			1817.32.2700.D*		2.060,00	1.688,52	
		3000 °K	1817.32.3000		1.954,00	1.601,64	
			1817.32.3000.D*		2.060,00	1.688,52	
Plastic covers, <i>Coperture plastica, Kunststoffabdeckungen, Cubiertas de plástico, Пластиковые крышки</i>			1817.32.KIT.COVER		446,00	365,57	

\* Dimmable with: PUSH 0-10V/1-10V/DALI / normally open button  
 Dimmerabile con: PUSH 0-10v / 1-10v/DALI / pulsante normalmente aperto  
 Dimmbar über: PUSH 0-10V / 1-10V/DALI / Taste normalerweise offen  
 Intensidad luminosa regulable con: PUSH 0-10v / 1-10v/DALI / botón normalmente abierta  
 Диммируется с помощью PUSH 0-10 В / 1-10 В/DALI / с нормально разомкнутой кнопкой

\*\* Dimmable with: TRIAC  
 Dimmerabile con: TRIAC  
 Dimmbar über: TRIAC  
 Intensidad luminosa regulable con: TRIAC  
 Диммируется с помощью TRIAC

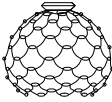
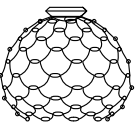
PRODUCT	FINISHES	°K	CODE	PAGE	PRICE € incl VAT (22%)	PRICE € excl VAT	
 <p><b>LAMOI</b> Ceiling lamp Ø 40</p>	Gold Oro Gold Oro Золото	2700 °K	1812.20.2700	227	1.125,00	922,13	
			1812.20.2700.D*		1.231,00	1.009,02	
		3000 °K	1812.20.3000		1.125,00	922,13	
			1812.20.3000.D*		1.231,00	1.009,02	
	Plastic covers, <i>Coperture plastica, Kunststoffabdeckungen, Cubiertas de plástico, Пластиковые крышки</i>				1812.20.KIT.COVER	220,00	180,33
	Copper Rame Kupfer Cobre Медь	2700 °K	1816.20.2700		227	1.125,00	922,13
			1816.20.2700.D*			1.231,00	1.009,02
		3000 °K	1816.20.3000			1.125,00	922,13
			1816.20.3000.D*	1.231,00		1.009,02	
	Plastic covers, <i>Coperture plastica, Kunststoffabdeckungen, Cubiertas de plástico, Пластиковые крышки</i>			1816.20.KIT.COVER		220,00	180,33
Chrome Cromo Chrom Cromo Хром	2700 °K	1817.20.2700	227	1.125,00		922,13	
		1817.20.2700.D*		1.231,00		1.009,02	
	3000 °K	1817.20.3000		1.125,00		922,13	
		1817.20.3000.D*		1.231,00	1.009,02		
	Plastic covers, <i>Coperture plastica, Kunststoffabdeckungen, Cubiertas de plástico, Пластиковые крышки</i>			1817.20.KIT.COVER	220,00	180,33	
 <p><b>LAMOI</b> Ceiling lamp Ø 60</p>	Gold Oro Gold Oro Золото	2700 °K	1812.21.2700	227	1.450,00	1.188,52	
			1812.21.2700.D*		1.556,00	1.275,41	
			1812.21.2700.DT**		1.556,00	1.275,41	
		3000 °K	1812.21.3000		1.450,00	1.188,52	
			1812.21.3000.D*		1.556,00	1.275,41	
			1812.21.3000.DT**		1.556,00	1.275,41	
	Plastic covers, <i>Coperture plastica, Kunststoffabdeckungen, Cubiertas de plástico, Пластиковые крышки</i>			1812.21.KIT.COVER	323,00	264,75	
	Copper Rame Kupfer Cobre Медь	2700 °K	1816.21.2700	227	1.450,00	1.188,52	
			1816.21.2700.D*		1.556,00	1.275,41	
			1816.21.2700.DT**		1.556,00	1.275,41	
		3000 °K	1816.21.3000		1.450,00	1.188,52	
			1816.21.3000.D*		1.556,00	1.275,41	
			1816.21.3000.DT*		1.556,00	1.275,41	
	Plastic covers, <i>Coperture plastica, Kunststoffabdeckungen, Cubiertas de plástico, Пластиковые крышки</i>			1816.21.KIT.COVER	323,00	264,75	
	Chrome Cromo Chrom Cromo Хром	2700 °K	1817.21.2700	227	1.450,00	1.188,52	
			1817.21.2700.D*		1.556,00	1.275,41	
1817.21.2700.DT**			1.556,00		1.275,41		
3000 °K		1817.21.3000	1.450,00		1.188,52		
		1817.21.3000.D*	1.556,00		1.275,41		
		1817.21.3000.DT**	1.556,00		1.275,41		
Plastic covers, <i>Coperture plastica, Kunststoffabdeckungen, Cubiertas de plástico, Пластиковые крышки</i>			1817.21.KIT.COVER	323,00	264,75		

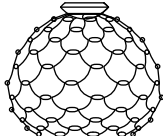
PRODUCT	FINISHES	°K	CODE	PAGE	PRICE € incl VAT (22%)	PRICE € excl VAT		
 <p><b>LAMOI</b> Ceiling lamp Ø 80</p>	Gold Oro Gold Oro Золото	2700 °K	1812.22.2700	227	1.922,00	1.575,41		
			1812.22.2700.D*		2.028,00	1.662,30		
		3000 °K	1812.22.3000		1.922,00	1.575,41		
			1812.22.3000.D*		2.028,00	1.662,30		
	Plastic covers, <i>Coperture plastica, Kunststoffabdeckungen, Cubiertas de plástico, Пластиковые крышки</i>			1812.22.KIT.COVER		446,00	365,57	
	Copper Rame Kupfer Cobre Медь	2700 °K	1816.22.2700	227	1.922,00	1.575,41		
			1816.22.2700.D*		2.028,00	1.662,30		
		3000 °K	1816.22.3000		1.922,00	1.575,41		
			1816.22.3000.D*		2.028,00	1.662,30		
	Plastic covers, <i>Coperture plastica, Kunststoffabdeckungen, Cubiertas de plástico, Пластиковые крышки</i>			1816.22.KIT.COVER		446,00	365,57	
Chrome Cromo Chrom Cromo Хром	2700 °K	1817.22.2700	227	1.922,00	1.575,41			
		1817.22.2700.D*		2.028,00	1.662,30			
	3000 °K	1817.22.3000		1.922,00	1.575,41			
		1817.22.3000.D*		2.028,00	1.662,30			
	Plastic covers, <i>Coperture plastica, Kunststoffabdeckungen, Cubiertas de plástico, Пластиковые крышки</i>			1817.22.KIT.COVER		446,00	365,57	

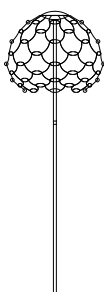
 <p><b>LAMOI</b> Floor lamp Ø 40</p>	Gold Oro Gold Oro Золото	2700 °K	1812.53.2700.D***	231	1.642,00	1.345,90	
		3000 °K	1812.53.3000.D***		1.642,00	1.345,90	
	Plastic covers, <i>Coperture plastica, Kunststoffabdeckungen, Cubiertas de plástico, Пластиковые крышки</i>			1812.53.KIT.COVER		220,00	180,33
	Copper Rame Kupfer Cobre Медь	2700 °K	1816.53.2700.D***	231	1.642,00	1.345,90	
		3000 °K	1816.53.3000.D***		1.642,00	1.345,90	
	Plastic covers, <i>Coperture plastica, Kunststoffabdeckungen, Cubiertas de plástico, Пластиковые крышки</i>			1816.53.KIT.COVER		220,00	180,33
	Chrome Cromo Chrom Cromo Хром	2700 °K	1817.53.2700.D***	231	1.642,00	1.345,90	
			1817.50.2700.D***	-	1.642,00	1.345,90	
		3000 °K	1817.53.3000.D***	231	1.642,00	1.345,90	
			1817.53.KIT.COVER			220,00	180,33
Plastic covers, <i>Coperture plastica, Kunststoffabdeckungen, Cubiertas de plástico, Пластиковые крышки</i>			1817.53.KIT.COVER		220,00	180,33	

\*\*\* Footswitch dimmer included.  
 Dimmer a pedale incluso.  
 Inklusive Fußdimmer.  
 Regulador de intensidad con pedal incluido.  
 В комплект входит диммер с ножным управлением.

\* Dimmable with: PUSH 0-10V/1-10V/DALI / normally open button  
 Dimmerabile con: PUSH 0-10v / 1-10v/DALI / pulsante normalmente aperto  
 Dimmbar über: PUSH 0-10V / 1-10V/DALI / Taste normalerweise offen  
 Intensidad luminosa regulable con: PUSH 0-10v / 1-10v/DALI / botón normalmente abierto  
 Диммируется с помощью PUSH 0-10 В / 1-10 В/DALI / с нормально разомкнутой кнопкой

\*\* Dimmable with: TRIAC  
 Dimmerabile con: TRIAC  
 Dimmbar über: TRIAC  
 Intensidad luminosa regulable con: TRIAC  
 Диммируется с помощью TRIAC

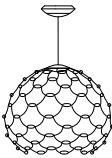
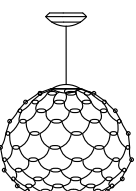
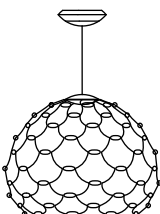
PRODUCT	FINISHES	°K	CODE	PAGE	PRICE € incl VAT (22%)	PRICE € excl VAT
 <p><b>LAMO I</b> Suspension lamp Ø 40</p>	Black Nero Schwarz Negro Черный	2700 °K	1831.30.2700	215	1.156,00	947,54
			1831.30.2700.D*		1.262,00	1.034,43
		3000 °K	1831.30.3000		1.156,00	947,54
			1831.30.3000.D*		1.262,00	1.034,43
	Plastic covers, <i>Coperture plastica, Kunststoffabdeckungen, Cubiertas de plástico, Пластиковые крышки</i>			1831.30.KIT.COVER		220,00
 <p><b>LAMO I</b> Suspension lamp Ø 60</p>	Black Nero Schwarz Negro Черный	2700 °K	1831.31.2700	215	1.482,00	1.214,75
			1831.31.2700.D*		1.588,00	1.301,64
			1831.31.2700.DT**		1.588,00	1.301,64
		3000 °K	1831.31.3000		1.482,00	1.214,75
			1831.31.3000.D*		1.588,00	1.301,64
			1831.31.3000.DT**		1.588,00	1.301,64
	Plastic covers, <i>Coperture plastica, Kunststoffabdeckungen, Cubiertas de plástico, Пластиковые крышки</i>			1831.31.KIT.COVER		323,00
 <p><b>LAMO I</b> Suspension lamp Ø 80</p>	Black Nero Schwarz Negro Черный	2700 °K	1831.32.2700	215	1.954,00	1.601,64
			1831.32.2700.D*		2.060,00	1.688,52
		3000 °K	1831.32.3000		1.954,00	1.601,64
			1831.32.3000.D*		2.060,00	1.688,52
	Plastic covers, <i>Coperture plastica, Kunststoffabdeckungen, Cubiertas de plástico, Пластиковые крышки</i>			1831.32.KIT.COVER		446,00

\* Dimmable with: PUSH 0-10V/1-10V/DALI / normally open button  
 Dimmerabile con: PUSH 0-10v / 1-10v/DALI / pulsante normalmente aperto  
 Dimmbar über: PUSH 0-10V / 1-10V/DALI / Taste normalerweise offen  
 Intensidad luminosa regulable con: PUSH 0-10v / 1-10v/DALI / botón normalmente abierto  
 Диммируется с помощью PUSH 0-10 В / 1-10 В/DALI / с нормально разомкнутой кнопкой

\*\* Dimmable with: TRIAC  
 Dimmerabile con: TRIAC  
 Dimmbar über: TRIAC  
 Intensidad luminosa regulable con: TRIAC  
 Диммируется с помощью TRIAC



PRODUCT	FINISHES	°K	CODE	PAGE	PRICE € incl VAT (22%)	PRICE € excl VAT
 <p><b>LAMOI</b> Ceiling lamp Ø 40</p>	Matt black Nero opaco Mattschwarz Negro mate Матовый черный	2700 °K	1831.20.2700	227	1.125,00	922,13
			1831.20.2700.D*		1.231,00	1.009,02
		3000 °K	1831.20.3000		1.125,00	922,13
			1831.20.3000.D*		1.231,00	1.009,02
		Plastic covers, <i>Coperture plastica, Kunststoffabdeckungen, Cubiertas de plástico, Пластиковые крышки</i>			1831.20.KIT.COVER	220,00
 <p><b>LAMOI</b> Ceiling lamp Ø 60</p>	Matt black Nero opaco Mattschwarz Negro mate Матовый черный	2700 °K	1831.21.2700	227	1.450,00	1.188,52
			1831.21.2700.D*		1.556,00	1.275,41
			1831.21.2700.DT**		1.556,00	1.275,41
		3000 °K	1831.21.3000		1.450,00	1.188,52
			1831.21.3000.D*		1.556,00	1.275,41
			1831.21.3000.DT**		1.556,00	1.275,41
		Plastic covers, <i>Coperture plastica, Kunststoffabdeckungen, Cubiertas de plástico, Пластиковые крышки</i>			1831.21.KIT.COVER	323,00
 <p><b>LAMOI</b> Ceiling lamp Ø 80</p>	Matt black Nero opaco Mattschwarz Negro mate Матовый черный	2700 °K	1831.22.2700	227	1.922,00	1.575,41
			1831.22.2700.D*		2.028,00	1.662,30
		3000 °K	1831.22.3000		1.922,00	1.575,41
			1831.22.3000.D*		2.028,00	1.662,30
		Plastic covers, <i>Coperture plastica, Kunststoffabdeckungen, Cubiertas de plástico, Пластиковые крышки</i>			1831.22.KIT.COVER	446,00

\* Dimmable with: PUSH 0-10V/1-10V/DALI / normally open button  
 Dimmerabile con: PUSH 0-10v / 1-10v/DALI / pulsante normalmente aperto  
 Dimmbar über: PUSH 0-10V / 1-10V/DALI / Taste normalerweise offen  
 Intensidad luminosa regulable con: PUSH 0-10v / 1-10v/DALI / botón normalmente abierto  
 Диммируется с помощью PUSH 0-10 В / 1-10 В/DALI / с нормально разомкнутой кнопкой

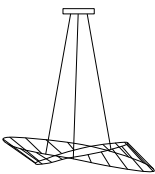
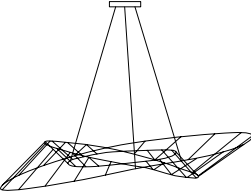
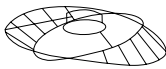
\*\* Dimmable with: TRIAC  
 Dimmerabile con: TRIAC  
 Dimmbar über: TRIAC  
 Intensidad luminosa regulable con: TRIAC  
 Диммируется с помощью TRIAC

PRODUCT	FINISHES	°K	CODE	PAGE	PRICE € incl VAT (22%)	PRICE € excl VAT
 <p><b>TESA</b> Suspension lamp 72x65</p>	Matt powder pink <i>Cipria opaco</i> <i>Puderrosa matt</i> <i>Rosa palo mate</i> Пудровый матовый	2700 °K	1837.31.2700	241	641,00	525,41
			1837.31.2700.D*		758,00	621,31
		3000 °K	1837.31.3000		641,00	525,41
			1837.31.3000.D*		758,00	621,31
	Matt copper <i>Rame opaco</i> <i>Kupfer matt</i> <i>Cobre mate</i> Медный матовый	2700 °K	1836.31.2700	241	641,00	525,41
			1836.31.2700.D*		758,00	621,31
		3000 °K	1836.31.3000		641,00	525,41
			1836.31.3000.D*		758,00	621,31
 <p><b>TESA</b> Suspension lamp 120x81</p>	Matt powder pink <i>Cipria opaco</i> <i>Puderrosa matt</i> <i>Rosa palo mate</i> Пудровый матовый	2700 °K	1837.30.2700	241	875,00	717,21
			1837.30.2700.D*		991,00	812,30
		3000 °K	1837.30.3000		875,00	717,21
			1837.30.3000.D*		991,00	812,30
	Matt copper <i>Rame opaco</i> <i>Kupfer matt</i> <i>Cobre mate</i> Медный матовый	2700 °K	1836.30.2700	241	875,00	717,21
			1836.30.2700.D*		991,00	812,30
		3000 °K	1836.30.3000		875,00	717,21
			1836.30.3000.D*		991,00	812,30
 <p><b>TESA</b> Ceiling lamp</p>	Matt powder pink <i>Cipria opaco</i> <i>Puderrosa matt</i> <i>Rosa palo mate</i> Пудровый матовый	2700 °K	1837.21.2700	253	641,00	525,41
			1837.21.2700.D*		758,00	621,31
		3000 °K	1837.21.3000		641,00	525,41
			1837.21.3000.D*		758,00	621,31
	Matt copper <i>Rame opaco</i> <i>Kupfer matt</i> <i>Cobre mate</i> Медный матовый	2700 °K	1836.21.2700	253	641,00	525,41
			1836.21.2700.D*		758,00	621,31
		3000 °K	1836.21.3000		641,00	525,41
			1836.21.3000.D*		758,00	621,31

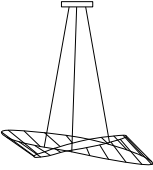
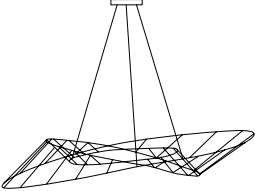
\* Dimmable with: PUSH 0-10V/1-10V/DALI / normally open button  
 Dimmerabile con: PUSH 0-10v / 1-10v/DALI / pulsante normalmente aperto  
 Dimmbar über: PUSH 0-10V / 1-10V/DALI / Taste normalerweise offen  
 Intensidad luminosa regulable con: PUSH 0-10v / 1-10v/DALI / botón normalmente abierto  
 Диммируется с помощью PUSH 0-10 В / 1-10 В/DALI / с нормально разомкнутой кнопкой

PRODUCT	FINISHES	°K	CODE	PAGE	PRICE € incl VAT (22%)	PRICE € excl VAT
 <p><b>TESA 2.0</b> Suspension lamp 72x65</p>	Matt black Nero opaco Mattschwarz Negro mate Матовый черный	2700 °K	1838.31.2700	263	641,00	525,41
			1838.31.2700.D*		758,00	621,31
		3000 °K	1838.31.3000		641,00	525,41
			1838.31.3000.D*		758,00	621,31
 <p><b>TESA 2.0</b> Suspension lamp 120x81</p>	Matt black Nero opaco Mattschwarz Negro mate Матовый черный	2700 °K	1838.30.2700	263	875,00	717,21
			1838.30.2700.D*		991,00	812,30
		3000 °K	1838.30.3000		875,00	717,21
			1838.30.3000.D*		991,00	812,30
 <p><b>TESA 2.0</b> Ceiling lamp</p>	Matt black Nero opaco Mattschwarz Negro mate Матовый черный	2700 °K	1838.21.2700	269	641,00	525,41
			1838.21.2700.D*		758,00	621,31
		3000 °K	1838.21.3000		641,00	525,41
			1838.21.3000.D*		758,00	621,31

\* Dimmable with: PUSH 0-10V/1-10V/DALI / normally open button  
 Dimmerabile con: PUSH 0-10v / 1-10v/DALI / pulsante normalmente aperto  
 Dimmbar über: PUSH 0-10V / 1-10V/DALI / Taste normalerweise offen  
 Intensidad luminosa regulable con: PUSH 0-10v / 1-10v/DALI / botón normalmente abierto  
 Диммируется с помощью PUSH 0-10 В / 1-10 В/DALI / с нормально разомкнутой кнопкой

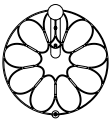
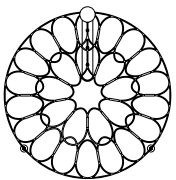
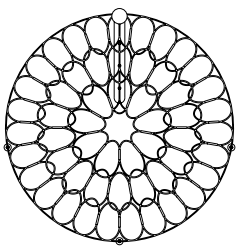
PRODUCT	FINISHES	°K	CODE	PAGE	PRICE € incl VAT (22%)	PRICE € excl VAT
 <p><b>LAFRA</b> Ceiling lamp Ø 45</p>	Chrome Cromo Chrom Cromo Хром	2700 °K	1833.21.2700	283	418,00	342,62
			1833.21.2700.DP*		455,00	372,95
		3000 °K	1833.21.3000		418,00	342,62
			1833.21.3000.DP*		455,00	372,95
	Plastic covers, <i>Coperture plastica, Kunststoffabdeckungen, Cubiertas de plástico, Пластиковые крышки</i>			1833.21.KIT.COVER		38,00
 <p><b>LAFRA</b> Ceiling lamp Ø 70</p>	Chrome Cromo Chrom Cromo Хром	2700 °K	1833.22.2700	283	707,00	579,51
			1833.22.2700.DP*		748,00	613,11
		3000 °K	1833.22.3000		707,00	579,51
			1833.22.3000.DP*		748,00	613,11
	Plastic covers, <i>Coperture plastica, Kunststoffabdeckungen, Cubiertas de plástico, Пластиковые крышки</i>			1833.22.KIT.COVER		111,00
 <p><b>LAFRA</b> Ceiling lamp Ø 95</p>	Chrome Cromo Chrom Cromo Хром	2700 °K	1833.23.2700	283	1.072,00	878,69
			1833.23.2700.DP*		1.109,00	909,02
		3000 °K	1833.23.3000		1.072,00	878,69
			1833.23.3000.DP*		1.109,00	909,02
	Plastic covers, <i>Coperture plastica, Kunststoffabdeckungen, Cubiertas de plástico, Пластиковые крышки</i>			1833.23.KIT.COVER		220,00

\* Dimmable with PUSH  
Dimmerabile con PUSH  
Dimmbar über PUSH  
Intensidad luminosa regulable con PUSH  
Диммируется с помощью PUSH

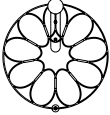
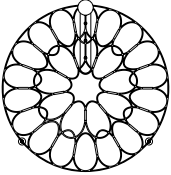
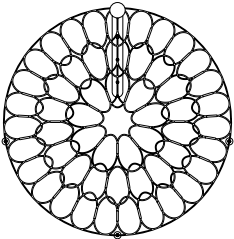
PRODUCT	FINISHES	°K	CODE	PAGE	PRICE € incl VAT (22%)	PRICE € excl VAT
 <p><b>LAFRA</b> Wall lamp Ø 45</p>	Chrome Cromo Chrom Cromo Хром	2700 °K	1833.11.2700	293	411,00	336,89
			1833.11.2700.DP*		442,00	362,30
		3000 °K	1833.11.3000		411,00	336,89
			1833.11.3000.DP*		442,00	362,30
	Plastic covers, <i>Coperture plastica, Kunststoffabdeckungen, Cubiertas de plástico, Пластиковые крышки</i>			1833.11.KIT.COVER		38,00
 <p><b>LAFRA</b> Wall lamp Ø 70</p>	Chrome Cromo Chrom Cromo Хром	2700 °K	1833.12.2700	293	694,00	568,85
			1833.12.2700.DP*		736,00	603,28
		3000 °K	1833.12.3000		694,00	568,85
			1833.12.3000.DP*		736,00	603,28
	Plastic covers, <i>Coperture plastica, Kunststoffabdeckungen, Cubiertas de plástico, Пластиковые крышки</i>			1833.12.KIT.COVER		111,00
 <p><b>LAFRA</b> Wall lamp Ø 95</p>	Chrome Cromo Chrom Cromo Хром	2700 °K	1833.13.2700	293	1.059,00	868,03
			1833.13.2700.DP*		1.096,00	898,36
		3000 °K	1833.13.3000		1.059,00	868,03
			1833.13.3000.DP*		1.096,00	898,36
	Plastic covers, <i>Coperture plastica, Kunststoffabdeckungen, Cubiertas de plástico, Пластиковые крышки</i>			1833.13.KIT.COVER		220,00

\* Dimmable with PUSH  
 Dimmerabile con PUSH  
 Dimmbar über PUSH  
 Intensidad luminosa regulable con PUSH  
 Диммируется с помощью PUSH

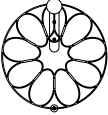
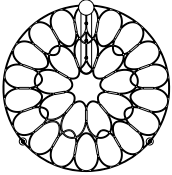
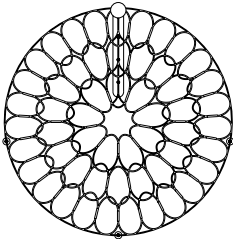
PRODUCT	FINISHES	°K	CODE	PAGE	PRICE € incl VAT (22%)	PRICE € excl VAT
 <p><b>LAFRA</b> Ceiling lamp Ø 45</p>	Matt black Nero opaco Mattschwarz Negro mate Матовый черный	2700 °K	1834.21.2700	283	418,00	342,62
			1834.21.2700.DP*		455,00	372,95
		3000 °K	1834.21.3000		418,00	342,62
			1834.21.3000.DP*		455,00	372,95
	Plastic covers, <i>Coperture plastica, Kunststoffabdeckungen, Cubiertas de plástico, Пластиковые крышки</i>	1834.21.KIT.COVER	38,00	31,15		
 <p><b>LAFRA</b> Ceiling lamp Ø 70</p>	Matt black Nero opaco Mattschwarz Negro mate Матовый черный	2700 °K	1834.22.2700	283	707,00	579,51
			1834.22.2700.DP*		748,00	613,11
		3000 °K	1834.22.3000		707,00	579,51
			1834.22.3000.DP*		748,00	613,11
	Plastic covers, <i>Coperture plastica, Kunststoffabdeckungen, Cubiertas de plástico, Пластиковые крышки</i>	1834.22.KIT.COVER	111,00	90,98		
 <p><b>LAFRA</b> Ceiling lamp Ø 95</p>	Matt black Nero opaco Mattschwarz Negro mate Матовый черный	2700 °K	1834.23.2700	283	1.072,00	878,69
			1834.23.2700.DP*		1.109,00	909,02
		3000 °K	1834.23.3000		1.072,00	878,69
			1834.23.3000.DP*		1.109,00	909,02
	Plastic covers, <i>Coperture plastica, Kunststoffabdeckungen, Cubiertas de plástico, Пластиковые крышки</i>	1834.23.KIT.COVER	220,00	180,33		

\* Dimmable with PUSH  
 Dimmerabile con PUSH  
 Dimmbar über PUSH  
 Intensidad luminosa regulable con PUSH  
 Диммируется с помощью PUSH

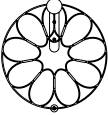
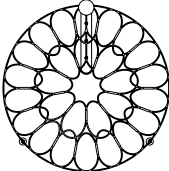
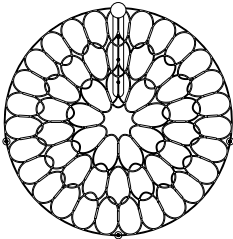
PRODUCT	FINISHES	°K	CODE	PAGE	PRICE € incl VAT (22%)	PRICE € excl VAT
 <p><b>LAFRA</b> Wall lamp Ø 45</p>	Matt black Nero opaco Mattschwarz Negro mate Матовый черный	2700 °K	1834.11.2700	293	411,00	336,89
			1834.11.2700.DP*		442,00	362,30
		3000 °K	1834.11.3000		411,00	336,89
			1834.11.3000.DP*		442,00	362,30
	Plastic covers, <i>Coperture plastica, Kunststoffabdeckungen, Cubiertas de plástico, Пластиковые крышки</i>	1834.11.KIT.COVER	38,00	31,15		
 <p><b>LAFRA</b> Wall lamp Ø 70</p>	Matt black Nero opaco Mattschwarz Negro mate Матовый черный	2700 °K	1834.12.2700	293	694,00	568,85
			1834.12.2700.DP*		736,00	603,28
		3000 °K	1834.12.3000		694,00	568,85
			1834.12.3000.DP*		736,00	603,28
	Plastic covers, <i>Coperture plastica, Kunststoffabdeckungen, Cubiertas de plástico, Пластиковые крышки</i>	1834.12.KIT.COVER	111,00	90,98		
 <p><b>LAFRA</b> Wall lamp Ø 95</p>	Matt black Nero opaco Mattschwarz Negro mate Матовый черный	2700 °K	1834.13.2700	293	1.059,00	868,03
			1834.13.2700.DP*		1.096,00	898,36
		3000 °K	1834.13.3000		1.059,00	868,03
			1834.13.3000.DP*		1.096,00	898,36
	Plastic covers, <i>Coperture plastica, Kunststoffabdeckungen, Cubiertas de plástico, Пластиковые крышки</i>	1834.13.KIT.COVER	220,00	180,33		

\* Dimmable with PUSH  
 Dimmerabile con PUSH  
 Dimmbar über PUSH  
 Intensidad luminosa regulable con PUSH  
 Диммируется с помощью PUSH

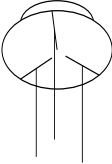
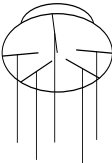
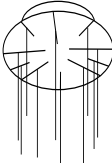
PRODUCT	FINISHES	CODE	PAGE	PRICE incl VAT (22%)	PRICE excl VAT
 <p><b>BEBA</b> Ceiling canopy</p>	<p>One-light ceiling canopy  <i>Montatura 1 luce</i>  <i>Baldachin 1 Leuchte</i>  <i>Rosetón 1 luz</i>  <i>Рамка с 1 светоэлементом</i></p>	<p><b>1730.M.30</b></p>	<p>313</p>	<p><b>78,00</b></p>	<p><b>63,93</b></p>
 <p><b>BEBA</b> Ceiling canopy</p>	<p>Three-lights round ceiling canopy  <i>Montatura tonda 3 luci Kit</i>  <i>Runder Baldachin 3 Leuchten-Set</i>  <i>Rosetón redondo 3 luces</i>  <i>Круглая рамка с 3 светоэлементами</i></p>	<p><b>1730.M.34</b></p>	<p>313</p>	<p><b>286,00</b></p>	<p><b>234,43</b></p>
 <p><b>BEBA</b> Ceiling canopy</p>	<p>Five-lights round ceiling canopy  <i>Montatura tonda 5 luci Kit</i>  <i>Runder Baldachin 5 Leuchten-Set</i>  <i>Rosetón redondo 5 luces</i>  <i>Круглая рамка с 5 светоэлементами</i></p>	<p><b>1730.M.35</b></p>	<p>313</p>	<p><b>445,00</b></p>	<p><b>364,75</b></p>
 <p><b>BEBA</b> Ceiling canopy</p>	<p>Ten-lights round ceiling canopy  <i>Montatura tonda 10 luci Kit</i>  <i>Runder Baldachin 10 Leuchten-Set</i>  <i>Rosetón redondo 10 luces</i>  <i>Круглая рамка с 10 светоэлементами</i></p>	<p><b>1730.M.36</b></p>	<p>313</p>	<p><b>948,00</b></p>	<p><b>777,05</b></p>

PRICE LIST \_ B E B A

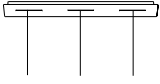
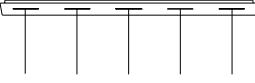
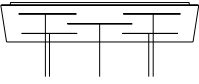
PRODUCT	FINISHES	CODE	PAGE	PRICE € incl VAT (22%)	PRICE € excl VAT
	<p>Three-light linear ceiling canopy with cables and lamp holder</p> <p><i>Montatura lineare 3 luci con cavi e portalampada</i> <i>Linearer Baldachin 3 Leuchten mit Kabeln und Lampenfassung</i> <i>Rosetón lineal 3 luces con cables y portalámparas</i> <i>Линейная рамка с 3 светозементами</i> <i>с кабелями и держателем лампы</i></p>	<b>1730.M.40</b>	313	<b>223,00</b>	<b>182,79</b>
	<p>Five-light linear ceiling canopy with cables and lamp holder</p> <p><i>Montatura lineare 5 luci con cavi e portalampada</i> <i>Linearer Baldachin 5 Leuchten mit Kabeln und Lampenfassung</i> <i>Rosetón lineal 5 luces con cables y portalámparas</i> <i>Линейная рамка с 5 светозементами</i> <i>с кабелями и держателем лампы</i></p>	<b>1730.M.41</b>	313	<b>347,00</b>	<b>284,43</b>
	<p>Five-light rectangular ceiling canopy with cables and lamp holder</p> <p><i>Montatura rettangolare 5 luci con cavi e portalampada</i> <i>Rechteckiger Baldachin 5 Leuchten mit Kabeln und Lampenfassung</i> <i>Rosetón rectangular 5 luces con cables y portalámparas</i> <i>Прямоугольная рамка с 5 светозементами</i> <i>с кабелями и держателем лампы</i></p>	<b>1730.M.42</b>	313	<b>448,00</b>	<b>367,21</b>

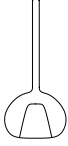
 <b>BEBA Glass</b> 15 x 35	<p>Trasparent <i>Trasparente</i> Transparent <i>Transparente</i> Прозрачный</p>	<b>1730.V.TR</b>	313	<b>78,00</b>	<b>63,93</b>
	<p>Chrome <i>Cromo</i> Chrom <i>Cromo</i> Хром</p>	<b>1730.V.CR</b>		<b>114,00</b>	<b>93,44</b>
	<p>Bronze <i>Bronzo</i> Bronze <i>Bronce</i> Бронза</p>	<b>1730.V.BZ</b>		<b>114,00</b>	<b>93,44</b>
	<p>Gold <i>Oro</i> Gold <i>Oro</i> Золото</p>	<b>1730.V.GOLD</b>		<b>114,00</b>	<b>93,44</b>

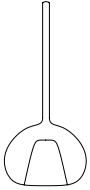
 <b>BEBA Glass</b> 20 x 45	<p>Trasparent <i>Trasparente</i> Transparent <i>Transparente</i> Прозрачный</p>	<b>1730.V.BIG.TR</b>	313	<b>164,00</b>	<b>134,43</b>
	<p>Chrome <i>Cromo</i> Chrom <i>Cromo</i> Хром</p>	<b>1730.V.BIG.CR</b>		<b>171,00</b>	<b>140,16</b>
	<p>Bronze <i>Bronzo</i> Bronze <i>Bronce</i> Бронза</p>	<b>1730.V.BIG.BZ</b>		<b>171,00</b>	<b>140,16</b>
	<p>Gold <i>Oro</i> Gold <i>Oro</i> Золото</p>	<b>1730.V.BIG. GOLD</b>		<b>171,00</b>	<b>140,16</b>

P R I C E L I S T

PRODUCT	FINISHES	CODE	PRICE € incl VAT (22%)	PRICE € excl VAT
<b>LINEA SUSPENSION</b>	LINEA SUSPENSION MT.0,4 LINEAR 2700	<b>1795.S5.2700</b>	<b>331,00</b>	<b>271,31</b>
	LINEA SUSPENSION MT.0,4 LINEAR 3000	<b>1795.S5.3000</b>	<b>331,00</b>	<b>271,31</b>
	LINEA SUSPENSION MT.0,9 LINEAR 2700	<b>1795.S6.2700</b>	<b>459,00</b>	<b>376,23</b>
	LINEA SUSPENSION MT.0,9 LINEAR 3000	<b>1795.S6.3000</b>	<b>459,00</b>	<b>376,23</b>







# U14.2

[urbanlighting.it](http://urbanlighting.it)

Headquarter / Showroom  
Viale Dell'Industria, 21  
20037 Paderno Dugnano (MI) Italia  
T. +39 02 9104958  
T. +39 02 9105178  
[info@sforzinilluminazione.com](mailto:info@sforzinilluminazione.com)